

Design with regard to explosions

Master's Thesis in the International Master's Programme Structural Engineering

ULRIKA NYSTRÖM

Department of Civil and Environmental Engineering

Division of Structural Engineering

Concrete Structures

CHALMERS UNIVERSITY OF TECHNOLOGY

Göteborg, Sweden 2006

Master's Thesis 2006:14

MASTER'S THESIS 2006:14

Design with regard to explosions

Master's Thesis in the International Master's Programme Structural Engineering

ULRIKA NYSTRÖM

Department of Civil and Environmental Engineering
Division of Structural Engineering
Concrete Structures

CHALMERS UNIVERSITY OF TECHNOLOGY

Göteborg, Sweden 2006

Design with regard to explosions

Master's Thesis in the International Master's Programme Structural Engineering
ULRIKA NYSTRÖM

© ULRIKA NYSTRÖM, 2006

Master's Thesis 2006:14
Department of Civil and Environmental Engineering
Division of Structural Engineering
Concrete Structures
Chalmers University of Technology
SE-412 96 Göteborg
Sweden
Telephone: + 46 (0)31-772 1000

Chalmers Reproservice / Department of Civil and Environmental Engineering
Göteborg, Sweden 2006

Design with regard to explosions

Master's Thesis in the International Master's Programme Structural Engineering

ULRIKA NYSTRÖM

Department of Civil and Environmental Engineering

Division of Structural Engineering

Concrete Structures

Chalmers University of Technology

ABSTRACT

When designing a construction to be able to withstand the high pressure caused by a shock wave simplifications can be used in order to facilitate the calculations. By literature studies simplified methods used to analyse beams subjected to dynamic loads are compiled and in some cases also compared with FE-analysis in order to verify the results.

The method of transforming and reducing deformable structures into single degree of freedom system, giving calculations easy to handle, is discussed in this report. When a beam is simplified into a single degree of freedom system the beam is assumed to have a specific shape of deformation and therefore tabled beam equations can be used in order to estimate the capacity of the beam. The beam equations can be used when the load is either infinity short (impulse load) or infinity long (pressure load). In order to utilize these equations also for arbitrary load durations so called damage curves are used. The behaviour of the structure subjected to dynamic loads can also be analysed by using an equivalent static load, where the impulse load is substituted with a static load that will give deflections corresponding to the ones achieved with the impulse load.

The simplified methods discussed above are valid for beams in general but since shelters often are made of reinforced concrete, which have a complex behaviour, these beams and their response to both static and dynamic loads will be studied more in detail. A short and brief review of the minimum requirements when designing shelters due to the Swedish shelter regulation will be done.

Key words: Explosions, dynamics, impulse load, reinforced concrete, SDOF system, equivalent static load, damage curves

Konstruktion med avseende på explosioner

Examensarbete inom civilingenjörsprogrammet Väg och vattenbyggnad

ULRIKA NYSTRÖM

Institutionen för bygg- och miljöteknik

Avdelningen för Betongbyggnad

Chalmers tekniska högskola

SAMMANFATTNING

Vid analyser och beräkningar av byggnader utsatta för explosionsartade laster kan förenklade handberäkningsmetoder användas. Genom litteraturstudier har några förenklade beräkningsmetoder studerats och sedan samlats i denna rapport. I vissa fall är resultat beräknade med hjälp av den förenklade beräkningsmetoden jämförda med resultat från FE-analys för att verifiera metoden.

Balkar, och andra deformerbara kroppar, kan omvandlas till ett enfrihetsgradsystem som tillskrivs ekvivalenta egenskaper för att ge samma deformation som den deformerbara kroppen. När balken har omvandlats till ett enfrihetsgradsystem kan tabellerade, så kallade, balkekvationer användas för att direkt uppskatta balkens respons, dessa är dock begränsade till att bara vara applicerbara för laster som beter sig mycket likt antingen en idealisk impuls- eller steglaster. Med hjälp av skadetabeller eller skadekurvor kan också responsen för mer generella laster uppskattas. För att kunna utnyttja den för ingenjörer välbekanta beräkningsgången för statiska lastfall kan en ekvivalent statisk last beräknas utifrån det dynamiska lastfallet.

De förenklade beräkningsmetoderna är generella och kan användas för olika balkar och materialtyper. Eftersom skyddsrum, och andra byggnader som dimensioneras för explosionslaster oftast är gjorda av armerad betong behandlas detta material mer i detalj.

Användningen av de ovan nämnda förenklade beräkningsmetoderna kräver dock en viss förståelse av hur balkar utsatta för starka, dynamiska laster uppför sig i verkligheten.

Nyckelord: Explosioner, dynamik, impuls last, armerad betong, enfrihetsgradsystem, SDOF-system, ekvivalent statisk last, skadekurvor

Contents

ABSTRACT	I
SAMMANFATTNING	II
CONTENTS	III
PREFACE	IX
NOTATIONS	X
1 INTRODUCTION	1
1.1 Background	1
1.2 Aim	1
1.3 Method	1
1.4 Limitations	2
1.5 Outline of the report	2
2 EXPLOSIONS	4
3 MATERIALS	7
3.1 Material responses	7
3.1.1 Linear elastic material	7
3.1.2 Ideal plastic material	8
3.1.3 Trilinear material	9
3.2 Theory of plasticity and plastic hinges	12
4 BASIC DYNAMICS	18
4.1 Kinematics	18
4.1.1 Velocity	18
4.1.2 Acceleration	19
4.2 Kinetics	19
4.2.1 Definitions of impulse and work	19
4.2.1.1 Impulse	19
4.2.1.2 Work	21
4.2.2 Mechanical vibrations	22
4.2.2.1 Undamped free vibration	23
4.2.2.2 Undamped forced vibration	25
4.2.2.3 Damped free vibration	26
4.2.2.4 Damped forced vibration	27
4.2.3 Beam vibrations	28

5	SOLUTION OF EQUILIBRIUM EQUATIONS IN DYNAMIC ANALYSIS	30
5.1	The Newmark method	31
5.2	The central difference method	33
5.2.1	Linear elastic material	34
5.2.2	Ideal plastic material	37
6	TRANSFORMATION FROM DEFORMABLE BODY TO SDOF SYSTEM	40
6.1	Differential equation for SDOF system	41
6.2	Transformation factors for beams	42
6.2.1	Transformation factor for the mass	42
6.2.2	Transformation factor for the load	44
6.2.3	Transformation factor for internal force	45
6.2.3.1	Linear elastic material	46
6.2.3.2	Ideal plastic material	49
6.2.3.3	Trilinear response material	51
6.2.4	Tabled transformation factors for beams	51
7	COMPARISON OF SDOF AND FE ANALYSES FOR BEAMS	53
7.1	Typical examples	53
7.1.1	SDOF analysis	56
7.1.2	FE model	57
7.2	Results	60
7.2.1	Linear elastic material	60
7.2.2	Ideal plastic material	61
7.2.3	Trilinear material	62
7.2.3.1	Elastic range	62
7.2.3.2	Elastoplastic range	63
7.2.3.3	Plastic range	64
8	COMMENTS TO AND DISCUSSION ABOUT CHAPTER 7	68
8.1	Transformation factors for trilinear material	68
8.1.1	Sudden change of transformation factors	68
8.1.2	Constant transformation factors	71
8.2	Discussion about FE models used in analyses	72
9	PRESSURE AND IMPULSE LOAD ACTING ON SDOF SYSTEM	73
9.1	Pressure load	73
9.2	Impulse load	75
9.3	Determination of capacity for beams transformed to SDOF systems	77
9.3.1	Linear elastic material	78
9.3.2	Ideal plastic material	79
9.3.3	Summary of capacity for beams transformed to SDOF systems	80
9.4	Capacity for SDOF systems	81

10	EQUIVALENT STATIC LOAD	83
10.1	SDOF system	83
10.1.1	Linear elastic material	84
10.1.2	Ideal plastic material	85
10.2	Beams	85
10.2.1	Linear elastic material	86
10.2.2	Ideal plastic material	87
11	DAMAGE CURVES	89
11.1	Calculation equations	89
11.1.1	Linear elastic material	90
11.1.1.1	γ_p known	91
11.1.1.2	γ_l known	91
11.1.2	Ideal plastic material	92
11.1.2.1	γ_p known	93
11.1.2.2	γ_l known	93
11.2	Results	93
11.3	Practical use of tables of damage	97
11.3.1	Solution process	97
11.3.2	Example	98
11.4	Practical use of damage curves	100
11.4.1	Solution process	100
11.4.2	Example	102
12	CONCRETE	104
12.1	Material behaviour	105
12.2	Analysis of cross-sections subjected to bending	108
12.2.1	Calculations in stadium I and II	109
12.2.1.1	Strain distribution for the cross-section	109
12.2.1.2	Assumptions	111
12.2.1.3	Transformed cross-section	112
12.2.1.4	Crack criteria	113
12.2.1.5	Reinforced cross-section in stadium I	114
12.2.1.6	Reinforced cross-section in stadium II	115
12.2.2	Calculations in stadium III	116
12.2.2.1	Failure criteria	117
12.2.2.2	Reinforced rectangular cross-section in stadium III	117
12.2.2.3	Rotational capacity	119
12.3	Requirements of structural parts and materials in shelters due to Swedish shelter regulations	122
12.4	Example; minimum amount of reinforcement	124
12.4.1	Linear elastic behaviour	127
12.4.2	Ideal plastic behaviour	128
12.5	Example; not minimum amount of reinforcement	129

13	CONCLUSIONS AND IDEAS OF FURTHER INVESTIGATIONS	131
14	REFERENCES	132

APPENDICIES

- APPENDIX A TRANSFORMATION FACTORS FOR LINEAR ELASTIC MATERIAL
- APPENDIX B TRANSFORMATION FACTORS FOR IDEAL PLASTIC MATERIAL
- APPENDIX C COMPARISON WITH TRANSFORMATION FACTOR ACCORDING TO GRANSTRÖM AND BALAZS
- APPENDIX D INPUT DATA IN ANALYSES
- APPENDIX E VARYING NUMBER OF ELEMENTS AND SIZE OF MODULUS OF ELASTICITY IN FE-ANALYSES
- APPENDIX F STANDARDIZED SHAPES OF DEFLECTION
- APPENDIX G BEAM EQUATIONS FOR LINEAR ELASTIC AND IDEAL PLASTIC MATERIAL
- APPENDIX H TABLES OF DAMAGE
- APPENDIX I CALCULATIONS TO EXAMPLE

Preface

In this Master's Thesis methods to simplify analyses of beams subjected to dynamic loads, arose from explosions, are compiled and investigated. The project has been performed within a co-operation between Reinertsen Sverige AB and the Division of Structural Engineering at the Department of Civil and Environmental Engineering of Chalmers University of Technology, Göteborg. The work has been carried out at Reinertsen's office in Göteborg from August 2005 to February 2006.

Morgan Johansson, PhD, and Ulrika Wendt, PhD, both from Reinertsen Sverige AB, have supervised me with engagement. I specially thank them for their support and good ideas. Thanks also to the rest of Reinertsen's staff for answering sundry questions appeared during the work.

My opponent, David Martínez, has continually assisted with the development of this thesis and I thank him for grateful help and good ideas of improvements.

Finally, I want to thank my family and friends especially Hans Gunnarsson for great support.

Göteborg February 2006

Ulrika Nyström

Notations

Roman upper case letters

A	Area
A_I	Equivalent area in stadium I
A_{II}	Equivalent area in stadium II
C	Damping
C_e	Equivalent damping
E	Modulus of elasticity
E'	Inclination of stress-strain relation in elastoplastic range
E_c	Modulus of elasticity for concrete
E_s	Modulus of elasticity for steel
G	Shear modulus
I	Moment of inertia
I	Impulse (general)
I_c	Characteristic impulse
K	Stiffness
K'	Inclination of load-displacement curve in elastoplastic range
K_e	Equivalent stiffness
L	Length of the beam
M	Mass
M	Moment
M_A, M_B	Moments at support A and B, respectively
M_e	Equivalent mass
M_{el}	Maximum moment in elastic range
M_{pl}	Ultimate moment, all fibres in a cross-section have yielded
M_f	Maximum field moment
M_s	Support moment
M_{spl}	Moment when yielding starts
N	Axial force
P	External load
\bar{P}	Mean value of external load
P^{static}	Equivalent static, concentrated, load
P_c	Characteristic pressure load
P_{cr}	External load when first crack occurs
P_{spl}	External load when yielding starts
P_{pl}	External, ultimate load
P_1	Peak value of transient load
R	Internal force
R_{cr}	Internal force when first crack occurs
R_e	Equivalent internal force
R_m	Maximum internal force

R_{spl}	Internal force when yielding starts
V	Shear force
W_k	Kinetic energy

Roman lower case letters

a	Acceleration
\bar{a}	Mean acceleration
b	Width of beam/cross-section
d	Effective height of cross-section
f_k	Characteristic value of material property
f_d	Design value of material property
f_{st}	Yield stress for steel
h	Height of beam/cross-section
i	Distributed impulse
q	Distributed load
q^{static}	Equivalent static, uniformly distributed, load
q_{cr}	Distributed load when first crack occurs
q_{el}	Maximum value of distributed load in elastic range
q_{pl}	Distributed ultimate load
q_{spl}	Distributed load when yielding starts
q_{elpl}	Load when plastic hinges are formed but the beam is not yet a mechanism
p	Momentum
t	Time
t_1	Total time duration of transient load
u	Displacement/deflection
\dot{u}	First derivative of u with respect to time t , velocity
\ddot{u}	Second derivative of u with respect to time t , acceleration
$u''(x)$	Curvature
u_{cr}	Displacement/deflection when first crack occurs
u_{pl}	Displacement/deflection corresponding to ultimate load
u_s	Displacement of system point
u_{spl}	Displacement/deflection when yielding starts
v	Velocity
\dot{v}	First derivative of v with respect to time t , acceleration
\bar{v}	Mean velocity
v_s	Velocity of system point
x	Coordinate
z	Coordinate, distance from compressed edge in cross-section

Greek upper case letters

Π	Work
Π_i	Internal work
Π_e	External work

Greek lower case letters

ε	Strain
$\dot{\varepsilon}$	Strain velocity
ε_c	Concrete strain
ε_{cr}	Strain when first crack occurs
ε_{cu}	Ultimate concrete strain
ε_{pl}	Strain for ultimate load
ε_{spl}	Strain when yielding starts
γ_I	Impulse load factor
γ_n	Partial safety factor taking the safety class into consideration
γ_m	Partial safety factor taking the insecurity when determining parameters into consideration
γ_P	Pressure load factor
η	Partial safety factor used in the Swedish code BBK 04
κ^{el}	Transformation factor for linear elastic material
κ^{elpl}	Average value of transformation factor for linear elastic and ideal plastic material
κ^{pl}	Transformation factor for ideal plastic material
κ_K	Transformation factor for the internal force
κ_{KP}	Combined transformation factor for the internal force and external load
κ_M	Transformation factor for the mass
κ_{MP}	Combined transformation factor for the mass and external load
κ_P	Transformation factor for the external load
ρ	Density
ρ	Reinforcement amount
σ	Stress
σ_c	Concrete stress
σ_{cr}	Stress when first crack occurs
σ_{pl}	Ultimate stress/Yield stress
σ_s	Steel stress
σ_{spl}	Stress when yielding starts
σ_y	Yield stress
ω	Circular frequency
τ	Shear stress
ν	Poisson's ratio

1 Introduction

1.1 Background

Explosions are accidental or intentional actions that need to be considered in the design of structures for various applications. Except from apparent cases, such as military installations and civil defence shelters, design with regard to explosions is required for instance in the processing industry and for tunnels.

When designing a construction to be able to withstand the high pressure caused by a shock wave (for example shelters), simplifications can be used in order to facilitate the calculations.

The methods used are rather well documented when having a linear elastic or ideal plastic material but shelters, and other structures exposed for shock loads, are often made of reinforced concrete which has a more complex behaviour. This makes the application of the methods more complicated and in order to keep the calculations easy to handle simplifications must be used. In practice, engineers usually not need to perform dynamic calculations why it is of interest to translate a dynamic load and its affects to a static load case giving similar response.

1.2 Aim

The aim of this thesis is to put together information about available design approaches for impact loading on structures in general and reinforced concrete structures in particular.

It shall be described how structures can be designed for impulse loading by means of simple hand-calculation approaches and to examine the agreement between such simple methods and more advanced analyses like FE analyses. These methods and the corresponding calculation processes shall be carefully described and documented.

The response of a structure subjected to a load also depends on the material behaviour and the difference in the response for linear elastic and ideal plastic materials shall be examined.

1.3 Method

Literature studies have been done in order to find, understand and compile different simple methods used when analysing the behaviour of structures exposed for transient loads. The agreement between such simple methods is investigated by comparing analyse results with the real behaviour, assumed to be found by using finite element method. The finite element analyses are made by means of the commercial finite element software ADINA (2004). Literature studies have also been made in order to get a deeper understanding of explosions, their appearance, laps and effects.

A beam with cross-section chosen according to requirements in the Swedish shelter regulations will be analysed. The capacity of the beam is calculated by means of the Swedish code BBK 04, see Boverket (1994), and directions in the Swedish shelter regulations, Räddningsverket (2003).

1.4 Limitations

The methods described in this thesis, used in order to simplify analyses of structures subjected to transient loads, can be used on different types of deformable structures. However, only the application on beams is shown in this thesis.

Complex material behaviour leads to complex calculations and expressions why only idealized material behaviours; linear elastic, ideal plastic and trilinear material respectively, is used here. When analysing concrete beams the effects of temperature, creep and shrinkage is not taken into account.

Explosions and their effects is a huge subject which requires long time to fully understand. Due to the limited time and in order to keep this scope within reasonable limits only explosions in air and the transient loads caused by them are discussed in this thesis. Secondary effects from the explosions such as collapse of nearby buildings are also not taken into account.

1.5 Outline of the report

The outline of the report can be divided into basic theory (Chapters 2 to 5), design methods (Chapters 6 to 11) and application of the design methods (Chapter 12).

In Chapters 2, to 5 basic theory of explosions in air, material responses, dynamics and solutions methods for differential equations are shown in order to facilitate the understanding for the rest of the report.

Since analyses of the response of beams subjected to dynamic loads requires a good knowledge of dynamics and heavy calculations, not manageable to perform by hand, it is of interest to simplify these calculations. In Chapter 6 it is discussed how the response of beams subjected to dynamic loads can be calculated by transforming the beam to an equivalent single degree of freedom system (SDOF system) which will achieve the same displacement as a prescribed point in the beam, the so called system point. When transforming beams to equivalent single degree of freedom systems transformation factors for the load, mass and the internal force are used. These are derived for linear elastic and ideal plastic material respectively In case of trilinear material the transformation factors are not derived instead it is discussed how the transformation factors for linear elastic and ideal plastic material can be used in order to transform beams with trilinear material behaviour, for example reinforced concrete beams, to equivalent single degree of freedom systems.

In Chapter 7 the response of a beam calculated by use of the method described above is compared with results from finite element analyses, which are assumed to give results close enough to the reality.

The choice of transformation factors in case of trilinear material is not trivial and is further discussed in Chapter 8 where also the FE models used in Chapter 7 are discussed.

Characteristic pressure and impulse loads are two idealized loads which are defined and discussed in Chapter 9. Here also expressions for the maximum displacement for single degree of freedom systems and to beams equivalent single degree of freedom systems are derived.

When calculating the response of a beam subjected to a dynamic load differential equations have to be solved for each time step in the analysis. Even though the use of equivalent single degree of freedom systems simplifies the calculations a lot it is very hard to perform results for a general load case without use of computers.

The response of a general impulse load acting on a beam or single degree of freedom system can be calculated by replacing the impulse load with an equivalent static load. The expressions for the, to the impulse load, equivalent static load is derived and shown in Chapter 10.

In case of a general load, somewhere in between a characteristic impulse and pressure load, the response of a single degree of freedom system can be estimated by use of either tables of damage or damage curves. In Chapter 11 the values in the tables of damage are calculated and the corresponding damage curves are shown for linear elastic and ideal plastic material. It is also discussed and shown how these can be used in practice.

Concrete is a complex material and therefore also the response of reinforced concrete beams are complex. In Chapter 12 the behaviour of a reinforced concrete beam subjected to dynamic loads is discussed.

In Chapter 13 conclusions and ideas on further investigations are shown.

2 Explosions

Here only a very brief review of explosions and their resulting shock waves are shown. For more and detailed information about this subject the reader is referred to for example Rådningverket (2004).

When a charge detonates in the air a sphere with very high temperature and pressure will form. This sphere will expand very fast and is spread as a shock wave from the centre of detonation. The temperature and the pressure will decrease with increased distance from the detonation centre, see Figure 2.1 below.

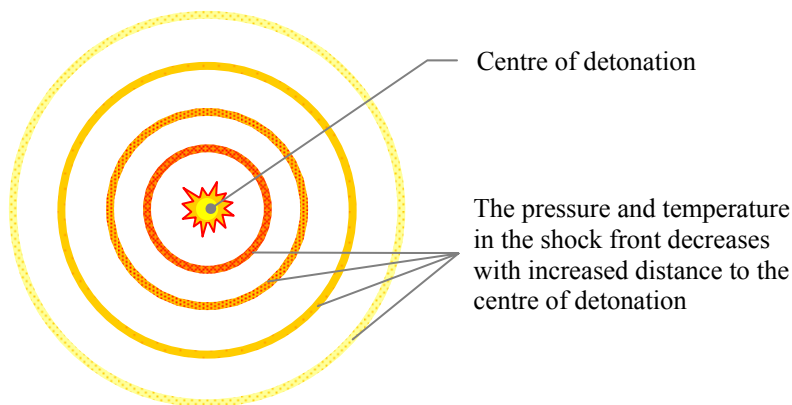

Figure 2.1 Schematic figure for detonation in air.

An idealized shock wave is shown in Figure 2.2 where the different phases can be seen. The shock front gives an instantaneously increase of pressure (and temperature) and is followed by the compression and negative phase. The meaning of the phases, and the devastation they can cause, are illustrated in Figure 2.2.

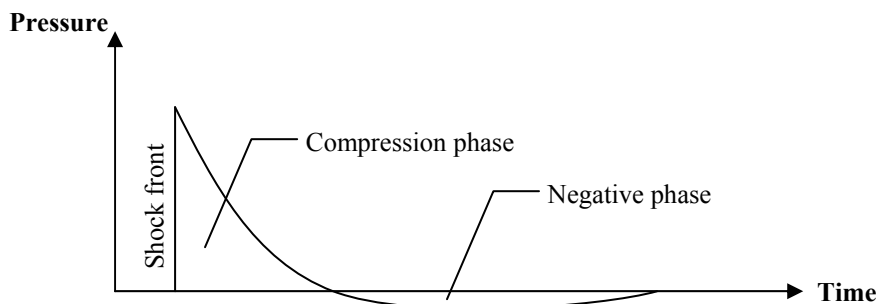

Figure 2.2 Idealized shock wave.

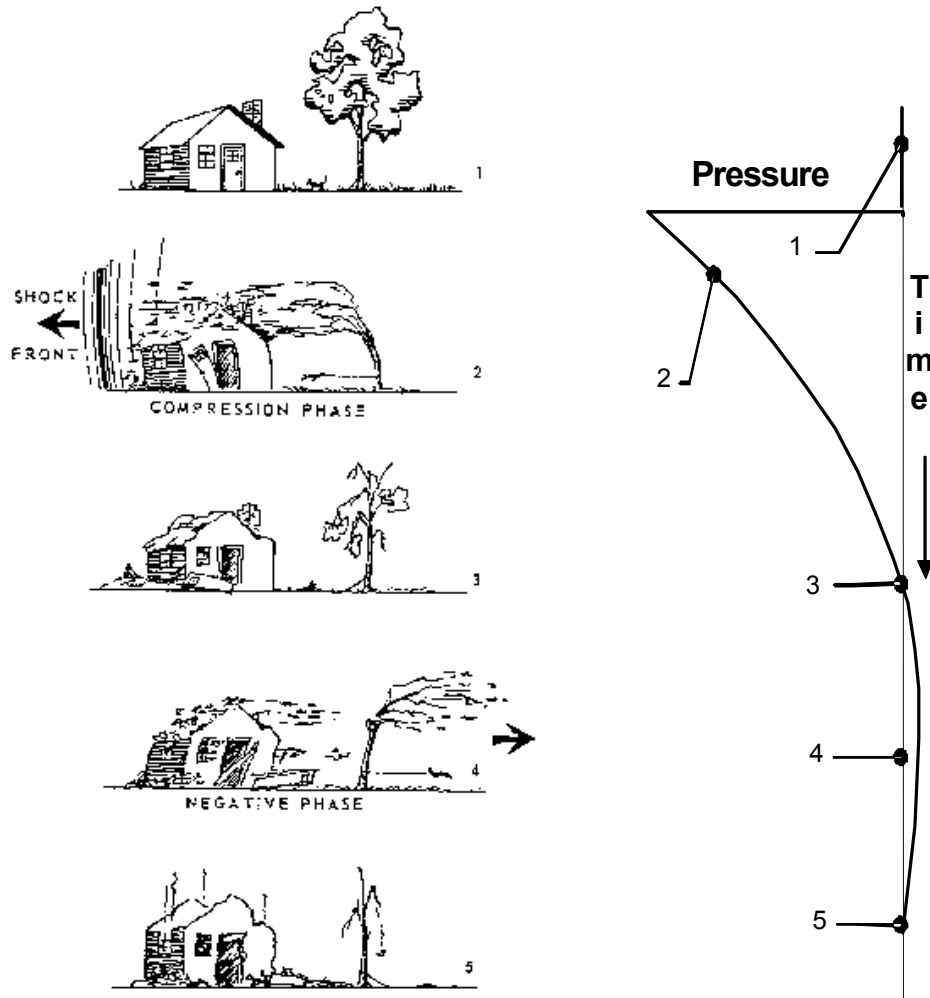

Figure 2.3 House exposed to shock wave. Based on NATO (1996).

When analysing buildings exposed for shock waves the transient load is often even more idealized than the one shown in Figure 2.2. In analyses made in this report the transient loads are assumed to have a simplified appearance, see Figure 2.4 where P_1 and t_1 is the maximum value of the load and the duration of the load respectively. The negative phase is not taken into account and the load is often assumed to be triangular in time.

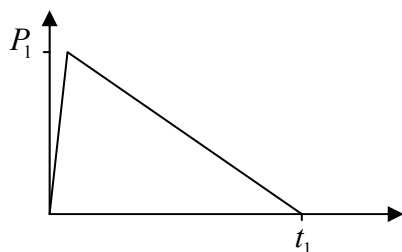

Figure 2.4 Idealized transient load caused by explosions used in this report.

When a bomb detonates close to a reflecting surface the intensity and the spreading of the resulting shock wave will be affected. For an idealized case, where the reflecting

surface is assumed not to absorb any energy, the shock wave spreading close to the surface will have twice the energy of a shock wave spreading in the air without any nearby reflecting surfaces as shown in Figure 2.5. This can be explained by the fact that half the energy amount is prevented from spreading in its natural direction, instead the energy is reflected.

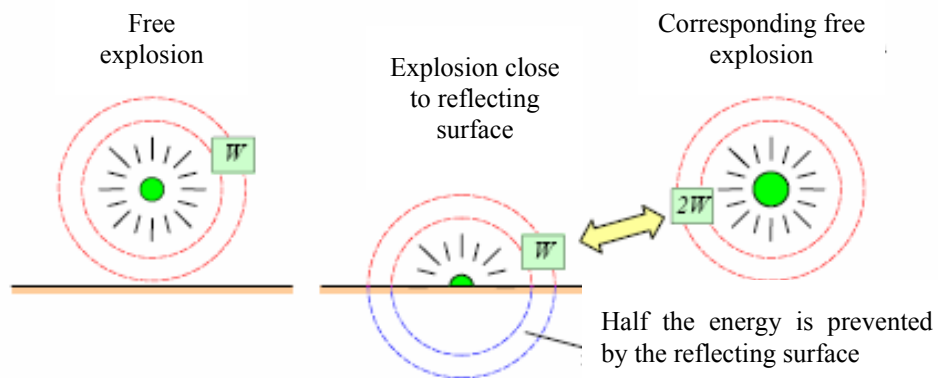

Figure 2.5 Explosion in air and close to reflecting surface respectively. Based on R ddningsverket (2004) where the notation W represents the size of the charge.

3 Materials

The response of a loaded structure is highly dependent of the material and its behaviour. In this report only idealized material behaviour are discussed; linear elastic, ideal plastic and a trilinear material. For ideal plastic and trilinear behaviour the fibres in the loaded structure can yield, meaning that the theory of elasticity is not applicable. In order to analyse a structure with plastic behaviour theory of plasticity and plastic hinges (further discussed in Section 3.2) are used in order to predict the response.

3.1 Material responses

3.1.1 Linear elastic material

In case of linear elastic material the stress σ is linear proportional to the strain ε in compliance with Hooke's law:

$$\sigma = E \cdot \varepsilon \quad (3.1)$$

where E is the modulus of elasticity. A principle relation between stress and strain for a linear elastic material is shown in Figure 3.1.

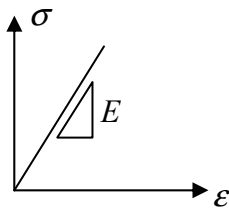

Figure 3.1 Principal relation between stress and strain for a linear elastic material.

The internal resisting force R in a structure subjected to a load will thus be linear proportional to the displacement u , i.e.:

$$R = K \cdot u \quad (3.2)$$

where K is the stiffness of the structure. A principle relation between the internal force and the displacement for a linear elastic material is shown in Figure 3.2.

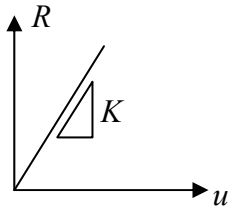

Figure 3.2 *Principal relation between internal force and displacement for a linear elastic material.*

The maximum value of the internal force in a structure with linear elastic material is:

$$R_m = K \cdot u_{max} \quad (3.3)$$

where u_{max} is the maximum value of the displacement. When the load is removed the structure will return to its unloaded position.

3.1.2 Ideal plastic material

The relation between stress σ and strain ε for an ideal plastic material is shown in Figure 3.3 where σ_y is the yield stress.

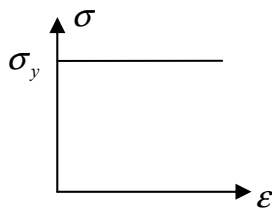

Figure 3.3 *Principal relation between stress and strain for an ideal plastic material.*

As seen in Figure 3.3 no deformations will occur until the stress is higher or equal to the yielding stress but as soon as the yield stress is reached and deformation starts the stress in the structure equals the yielding stress.

The internal force R in a structure, with ideal plastic material, subjected to a load P can now be expressed as:

$$\begin{aligned} R &= P & \text{for } P < R_m & \text{ if also } u = 0 \\ R &= R_m & \text{for } P \geq R_m & \text{ or } u \neq 0 \end{aligned} \quad (3.4)$$

where R_m is the maximum value of the internal force. A principle relation between the internal force and the displacement for an ideal plastic material is shown in Figure 3.4.

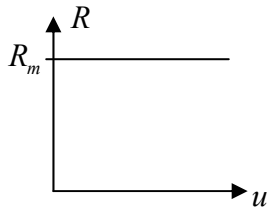

Figure 3.4 Principal relation between internal force and displacement for an ideal plastic material.

3.1.3 Trilinear material

Reinforced concrete beams have a trilinear material response. This is further discussed in Chapter 12 but here the idealized behaviour of reinforced concrete beams is shown. The idealized load-displacement curve for a concrete beam is shown in Figure 3.5 where R_{cr} is the internal force when the first crack occurs in the beam and R_m is the maximum value of the internal force valid when the ultimate load level is reached. u_{cr} and u_{pl} are the values of the displacement when the first crack occurs and when the ultimate load level is reached respectively. K is the stiffness before the first crack occurs and K' is the inclination of the curve in the range in between u_{cr} and u_{pl} .

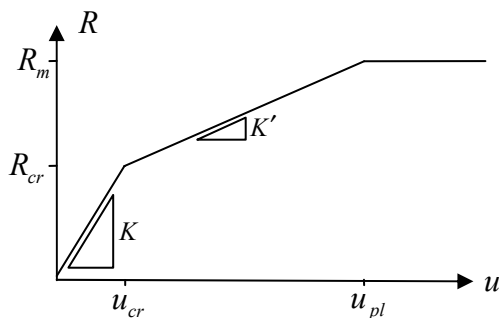

Figure 3.5 Principal relation between internal force and displacement for a trilinear material.

The internal force R in a structure, with trilinear material, subjected to a dynamic load $P(t)$ can be expressed as:

$$\begin{aligned}
 R &= Ku & \text{for } P(t) < R_{cr} \\
 R &= R_{cr} + K'(u - u_{cr}) & \text{for } R_{cr} \leq P(t) < R_m \\
 R &= R_m & \text{for } R_m \leq P(t)
 \end{aligned} \tag{3.5}$$

where R_{cr} also can be written as:

$$R_{cr} = K \cdot u_{cr} \tag{3.6}$$

The trilinear material response can be divided into elastic, elastoplastic and plastic range as shown in Figure 3.6.

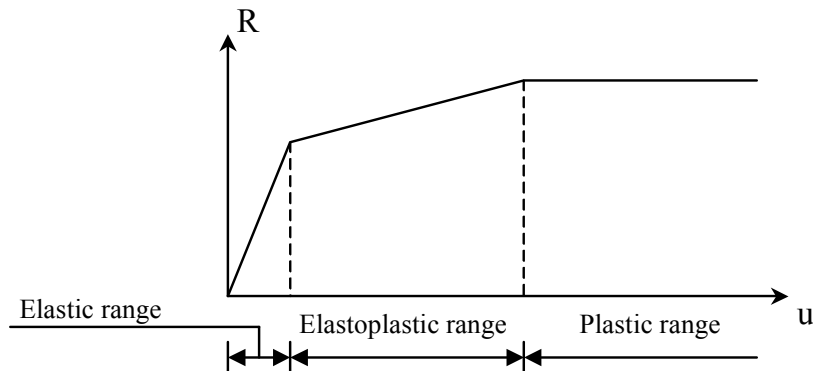

Figure 3.6 The different ranges for a trilinear material.

A reinforced concrete beam will have linear elastic behaviour until yielding starts. However, in this report linear elastic behaviour is assumed until the ultimate load is reached meaning that the stiffness of the beam in the range in between R_{cr} and R_m will change when the load increases, see Figure 3.7. This behaviour can be explained by the fact that more and more cracks will occur in the beam when the load increases.

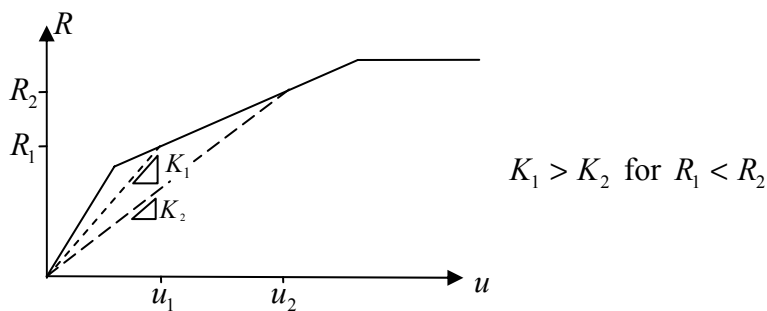

Figure 3.7 Stiffness in the elastoplastic range for a reinforced concrete beam.

Consider a beam subjected to a transient load with maximum value P_l large enough to give the internal force a value R_l . If the load is removed when $R_{cr} < R_l < R_m$ the beam will return to its unloaded position and the corresponding relation between the internal force and displacement is shown in Figure 3.8.

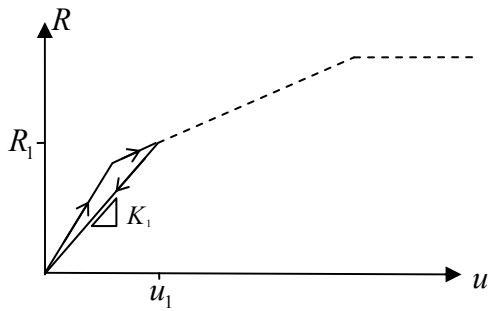

Figure 3.8 Response of a concrete beam when loading and unloading a force P_1 .

The beam is reloaded with a transient load with maximum value P_2 and the internal force will now reach a value R_2 . If the beam still is in the elastoplastic range ($R_{cr} < R_2 < R_m$) and the load is removed again the response curve is as shown in Figure 3.9.

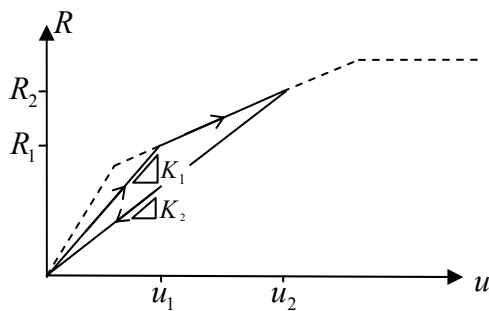

Figure 3.9 Response of a concrete beam when loading and unloading a force P_2 .

If, once again, a transient load is applied, this time with maximum value P_3 , big enough to reach the plastic range of the response curve ($R_3 = R_m$) and then the load is removed there are plastic deformations, see Figure 3.10. The stiffness when unloading is the same as the secant stiffness to the point (u_{pl}, R_m) . As soon as the plastic range is reached the stiffness of the beam is constant, as long as the failure criterion is not fulfilled.

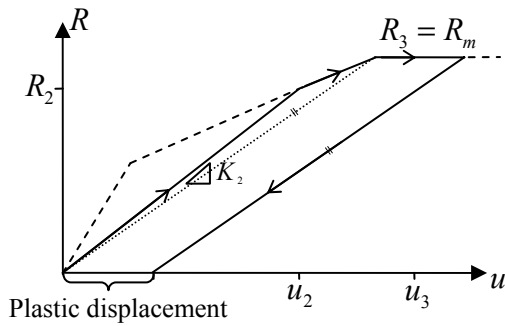

Figure 3.10 Response of a concrete beam when loading and unloading a force P_3 .

3.2 Theory of plasticity and plastic hinges

In this section theory of plasticity and plastic hinges for beams with double symmetric cross-sections are discussed. Theory of plasticity, as well as theory of elasticity, assumes a linear strain distribution over the height of the cross-section.

In the elastic range, when no fibres in the cross-section yield, Hooke's law is used as constitutive relation and the stress is linear proportional to the strain, see Equation (3.1). Therefore also the stress distribution will be linear distributed over the height of the cross-section in the elastic range. The stress and strain distributions in the elastic range for a cross-section in a beam subjected to pure bending are shown in Figure 3.11.

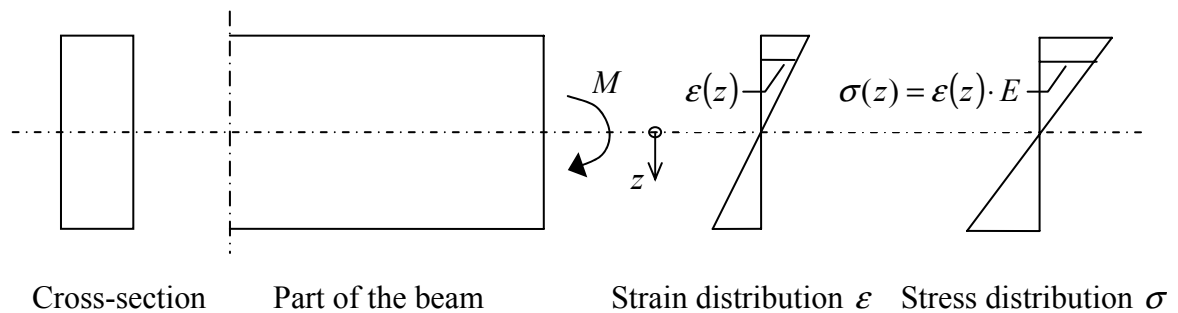

Figure 3.11 Stress and strain distribution in beam subjected to bending (in elastic range).

When the load applied to the beam, and consequently the bending moment inside the beam, has increases the outer, most stressed, fibres in the most strained section will reached the yield stress, see Figure 3.12.a. The maximum elastic moment has been reached and can be expressed as:

$$M_{el} = \frac{\sigma_y I}{h/2} \quad (3.7)$$

where σ_y is the yield stress, I is the moment of inertia and h is the height of the cross-section.

For a rectangular cross-section the moment of inertia is:

$$I = \frac{bh^3}{12} \quad (3.8)$$

where b is the width of the beam.

Inserting Equation (3.7) into Equation (3.8) the maximum elastic moment for a rectangular cross-section can be expressed as:

$$M_{el} = \sigma_y \frac{bh^2}{6} \quad (3.9)$$

If the load increases the elastoplastic range is entered and the stress will only be linear proportional to the strain in the part of the cross-section where yielding have not started, see Figure 3.12.b. The higher load the smaller elastic part and a proportional increasing curvature.

Just before all fibres in the cross-section has yielded the ultimate value of the moment M_{pl} is reached. The case when the whole cross-section has yield is an idealized state where the strain-stress curve has an infinitely long plastic range see Figure 3.12.c. Since the elastic part of the cross-section is infinitely small just before all fibres yield the ultimate moment, according to Samuelsson, Wiberg (1999), can be expressed as:

$$M_{pl} = \sigma_y \frac{bh^2}{4} \quad (3.10)$$

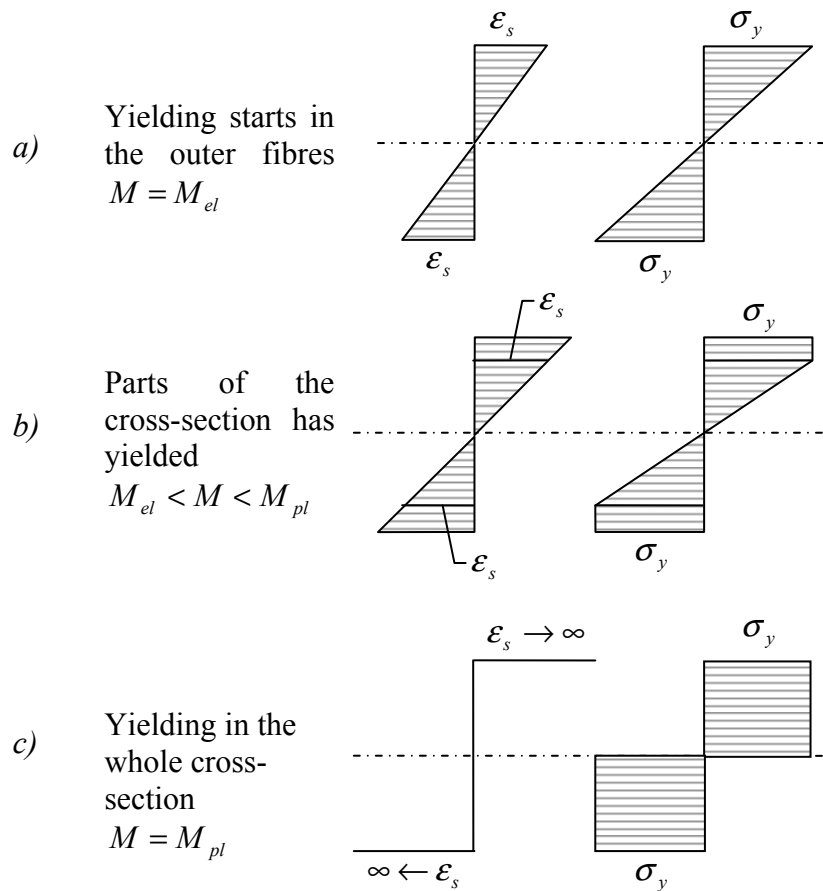

Figure 3.12 Stress and strain distributions in beam subjected to bending when a) yielding starts in the outer, most stressed, fibres, b) parts of the cross-section (and fibres close to the cross-section) have yielded and c) the whole cross-section has yielded (idealized case).

When the ultimate moment M_{pl} is reached in the most strained section almost all deformation occur here and in the very surrounding. The curvature is very large in this section while it is rather small in the rest of the beam. Since the length of the part with large curvature is very limited it can be assumed that all deformation takes place in a very small deformable element, a so called plastic hinge. The rest of the beam is assumed to be elastic and are therefore straight and the moment in the plastic hinges are assumed to be constantly equal to the ultimate moment M_{pl} . This reasoning is shown in Figure 3.13 for a simply supported and a fixed beam respectively.

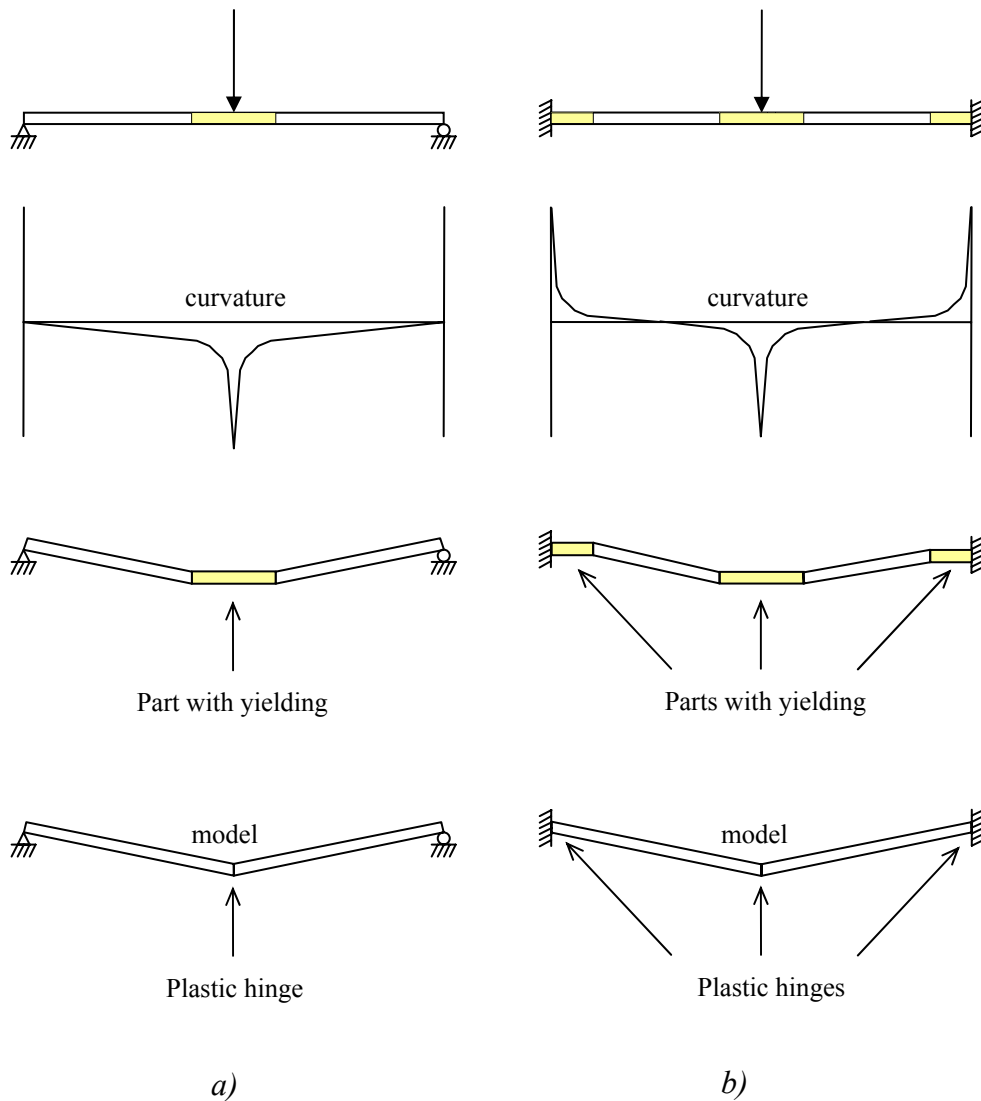

Figure 3.13 Models with plastic hinges for a) a simply supported beam and b) a fixed beam.

In case of simply supported beam only one plastic hinge is needed to create a mechanism and if the load increases even more the beam will undergo uncontrolled deformation.

For a fixed beam, with constant capacity, yielding starts at the supports and for a certain load plastic hinges are formed here. Since no mechanism is formed yet the load can be increased and the beam now acts as a simply supported beam subjected to moment M_{pl} at the supports. If the load remains constant at this level unlimited deformations can, in theory, occur. However, when the load is increased yielding starts also in the middle of the beam and when all fibres in this section have yielded a plastic hinge is formed and the beam has become a mechanism, see Figure 3.13.b. This is further discussed below where also the expressions for the moment at the different stages are shown.

For the fixed beam, subjected to a uniformly distributed load, the outer most stressed fibres at the supports will start to yield when the moment in this section is:

$$M_{el} = -\frac{q_{el}L^2}{12} \quad (3.11)$$

where q_{el} is the corresponding value of the uniformly distributed load and L is the length of the beam.

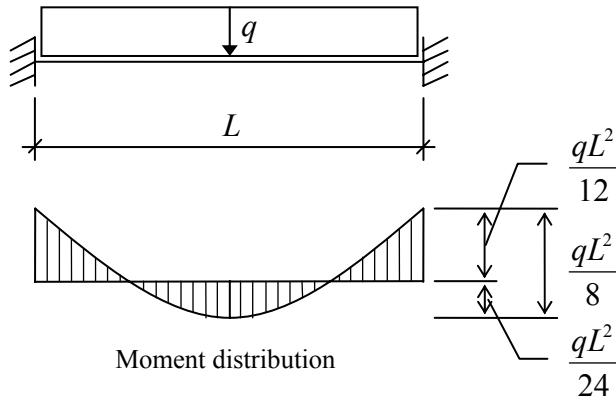

Figure 3.14 Moment distribution in beam subjected to uniformly distributed load according to theory of elasticity ($q \leq q_{el}$).

If the load is increased even more yielding zones will be formed at the supports and for a certain load q_{elpl} plastic hinges have been formed in these sections and the moment is:

$$M_{pl} = -\frac{q_{elpl}L^2}{12} \quad (3.12)$$

Due to the plastic hinges by the supports the beam now behaves like a simply supported beam subjected to support moments M_{pl} and the uniformly distributed load q if the load increases. The moment distribution is statically determinable. When the load increases even more the moment in the midpoint of the beam will reach the ultimate value M_{pl} and the beam is just about to form a plastic hinge in the midpoint. The moment in the midpoint is calculated by use of equilibrium conditions:

$$M_{middle} = M_{pl} = \frac{qL^2}{8} - M_{pl} \quad (3.13)$$

The uniformly distributed load q in Equation (3.13) is the load for which the mechanism is about to form and it is expressed as:

$$q = q_{pl} = \frac{16M_{pl}}{L^2} \quad (3.14)$$

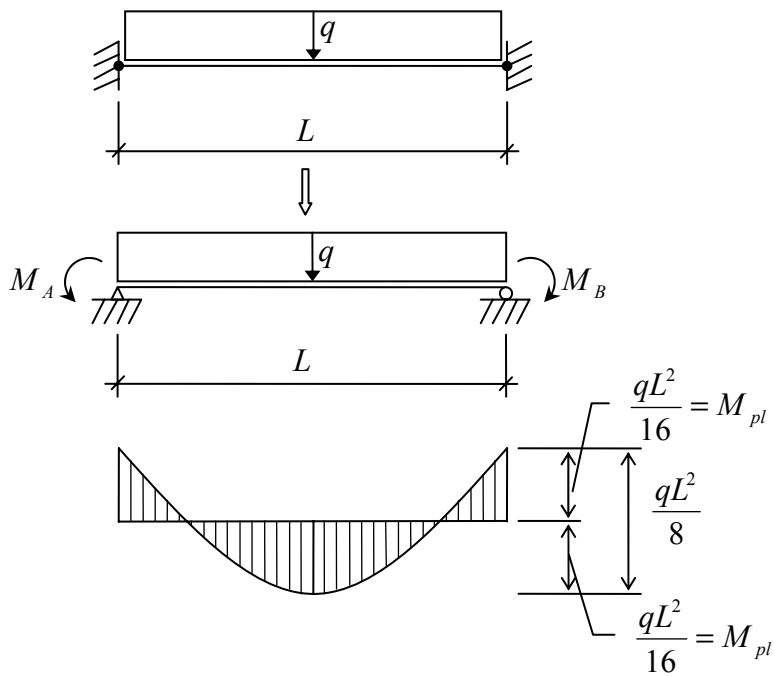

Figure 3.15 Moment distribution in beam subjected to uniformly distributed load when mechanism is about to form ($q = q_{pl}$).

4 Basic dynamics

The term dynamics is used for theory of moving systems and can be subdivided into kinematics and kinetics. Kinematics is a pure geometrical description of the movement while kinetics describes the cause of the movement (forces).

4.1 Kinematics

The simplest form of motion of a particle is when the particle moves along a linear axis (the x -axis in Figure 4.1) and the position of the particle is described by a vector $x(t)$ at time t . At time $t+\Delta t$ the position of the vector is $x+\Delta x$.

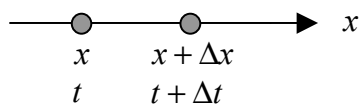

Figure 4.1 Linear motion of particle.

4.1.1 Velocity

The velocity of a particle moving linearly can be derived by studying how fast the position of the particle is changing. At time t the particle has position x and at time $t+\Delta t$ the position is $x+\Delta x$ meaning that during the time interval Δt the particle has moved the distance Δx . The mean velocity during the movement from position x to $x+\Delta x$ can then be stated as:

$$\bar{v} = \frac{\Delta x}{\Delta t} \quad (4.1)$$

Letting the time interval Δt go towards zero the change of distance Δx will approach 0. The mean value of the velocity will then approach a boundary value that is defined as the velocity of the particle at time t . The velocity of the particle is thus given by:

$$v(t) = v = \lim_{\Delta t \rightarrow 0} \frac{\Delta x}{\Delta t} = \frac{dx}{dt} \equiv \dot{x} \quad (4.2)$$

By definition the particle is moving in positive direction if the velocity is positive and vice versa.

4.1.2 Acceleration

The acceleration of a particle that is moving linearly can be derived by studying how fast the velocity of the particle is changing. At time t the particle has position x and velocity v and at time $t+\Delta t$ the position is $x+\Delta x$ and the corresponding velocity is $v+\Delta v$ meaning that during time interval Δt the velocity of the particle has increased with Δv . The average value of the acceleration can be stated as:

$$\bar{a} = \frac{\Delta v}{\Delta t} \quad (4.3)$$

In the same way as when deriving the velocity of the particle the acceleration can be written as:

$$a(t) = a = \lim_{\Delta t \rightarrow 0} \frac{\Delta v}{\Delta t} = \frac{dv}{dt} \equiv \dot{v} = \frac{d^2 x}{dt^2} \equiv \ddot{x} \quad (4.4)$$

When the particle is moving in the positive direction and the acceleration is positive, the velocity is increasing. A negative value of the acceleration gives retardation. If, instead, the particle is moving in the negative direction a positive value of the acceleration gives retardation and if the acceleration is negative the value of the velocity is increasing.

4.2 Kinetics

The response of bodies subjected to dynamic forces can be described by means of differential equations. Before deriving these equations of motions for dynamic loads the impulse of a load and the work performed by a load are defined.

4.2.1 Definitions of impulse and work

4.2.1.1 Impulse

Even though static, constant loads often are used in analyses loads are often varying in time and in order to describe how these forces influences the motion of the structure the impulse is introduced.

The impulse is defined as a step change in an object's momentum. For a mass, M , with velocity, v , the momentum is:

$$p = M \cdot v \quad (4.5)$$

At time t the impulse is I and at time $t+\Delta t$ the impulse is $I+\Delta I$ (see Figure 4.2) meaning that the increase of the impulse during time Δt is ΔI . As mentioned above the impulse is defined as the change in the momentum and the increase of the impulse can therefore, by means of Equation (4.5), be written as:

$$\Delta I = \Delta p = M \cdot \Delta v \quad (4.6)$$

where Δp is the change of the momentum during time Δt and Δv is the change of velocity during time Δt .

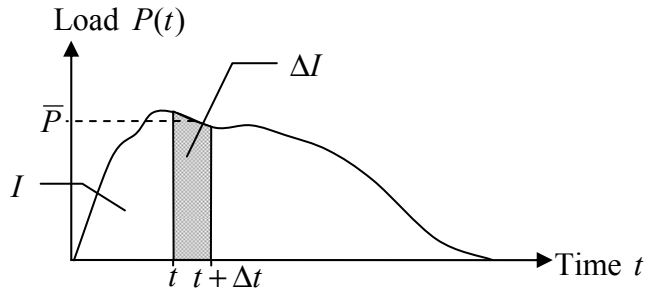

Figure 4.2 Load-time diagram where \bar{P} is the average value of the load in between time t and $t + \Delta t$.

The average value of the acceleration \bar{a} is defined in Equation (4.3) and together with Equation (4.6) the change of impulse during time Δt can be written as:

$$\Delta I = M \cdot \bar{a} \cdot \Delta t \quad (4.7)$$

By use of the second law of Newton where the force P is defined as the product of the mass and the acceleration the average value of the force \bar{P} is defined as:

$$\bar{P} = M \cdot \bar{a} \quad (4.8)$$

By use of Equations (4.7) and (4.8) the change of impulse can now be written as:

$$\Delta I = \bar{P} \cdot \Delta t \quad (4.9)$$

giving:

$$\bar{P} = \frac{\Delta I}{\Delta t} \quad (4.10)$$

Letting the time interval Δt go towards zero the change of impulse ΔI will approach zero as long as the impulse is not a characteristic impulse as shown in Figure 4.3. The meaning of a characteristic impulse is further discussed in Section 9.2.

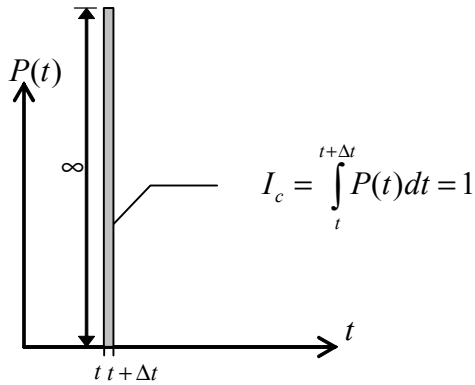

Figure 4.3 Characteristic impulse.

The mean value of the force will then approach a boundary value that is defined as the force applied to the particle at time t . The force applied to the particle is thus given by:

$$P(t) = P = \lim_{\Delta t \rightarrow 0} \frac{\Delta I}{\Delta t} = \frac{dI}{dt} \Leftrightarrow dI = P(t) \cdot dt \quad (4.11)$$

The change of the impulse can now, finally, be written as:

$$\int_I^{I+\Delta I} dI = \int_{t=t}^{t=t+\Delta t} P(t) dt \Leftrightarrow \Delta I = \int_{t=t}^{t=t+\Delta t} P(t) dt \quad (4.12)$$

The impulse for a load is thus:

$$I = \int_{t=0}^{t=t_1} P(t) dt \quad (4.13)$$

where t_1 is the time for which the load is removed.

4.2.1.2 Work

Work is a transfer of energy from one physical system to another, for example from a load to a structure. When there is no frictional force and a force acts on a body, the work done by the force is equal to the increase of the kinetic and potential energy of the body since all the energy expended by the exerting force must be gained by the body. However, in practice some energy will be lost due to friction and heat development.

When a particle is at position x the work is II and at position $x+\Delta x$ the work performed by the external load is $II+\Delta II$ (see Figure 4.4) meaning that the increase of work when the particle is moving the distance Δx is ΔII .

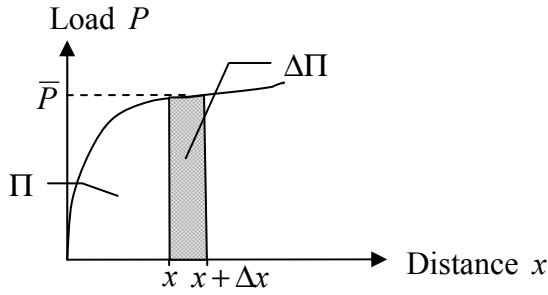

Figure 4.4 Load-distance diagram.

The change of work, represented by the shaded area in Figure 4.4, is expressed as:

$$\Delta\Pi = \bar{P} \cdot \Delta x \Leftrightarrow \bar{P} = \frac{\Delta\Pi}{\Delta x} \quad (4.14)$$

where \bar{P} is the average value of the force within the distance Δx .

Letting the distance Δx go towards zero the change of work $\Delta\Pi$ will approach 0. The mean value of the force will then approach a boundary value that is defined as the force causing the displacement x of the particle. This force is thus given by:

$$P(x) = P = \lim_{\Delta x \rightarrow 0} \frac{\Delta\Pi}{\Delta x} = \frac{d\Pi}{dx} \Leftrightarrow d\Pi = P(x) \cdot dx \quad (4.15)$$

The change of the work can now, finally, be written as:

$$\int_{\Pi}^{\Pi+\Delta\Pi} d\Pi = \int_{x=x}^{x=x+\Delta x} P dx \Leftrightarrow \Delta\Pi = \int_{x=x}^{x=x+\Delta x} P dx \quad (4.16)$$

The total work performed by a load P is thus:

$$\Pi = \int_{x=0}^{x=x_{max}} P dx \quad (4.17)$$

where x_{max} is the total displacement caused by the load.

4.2.2 Mechanical vibrations

When deriving basic dynamic equations a body where the position can be defined by one coordinate is used. Such structure is said to have one degree of freedom and is also referred to as single degree of freedom system and abbreviated as SDOF system (compare with MDOF, *Multi Degree Of Freedom* system). The mass-spring system in Figure 4.5 is an example of a system with one degree of freedom.

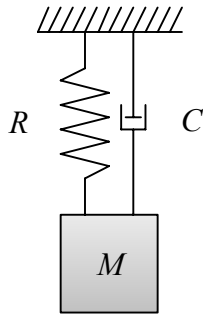

Figure 4.5 Mass-spring system with single degree of freedom, (SDOF).

The single degree of freedom system in Figure 4.5 represents a rigid mass, M , attached to a spring. In a rigid body there is no relative displacement between arbitrary points in the body. R is the internal force in the spring and C is the damping of the system.

When a mechanical system is moved from its unloaded equilibrium position the internal forces (for most materials) endeavour to bring it back to equilibrium position. This behaviour causes oscillations.

If vibrations take place in the absence of external forces but in presence of internal frictional forces the motion is referred to as damped free vibrations. If also the frictional forces are assumed to be absent the motion is called an undamped free vibration. If an external force is applied to the system the resulting motion is called forced vibration. The oscillation behaviour depends on whether the system is damped or undamped and if the vibrations are forced or not.

The undamped vibration is a hypothetical case but is, in many cases, assumed to be an adequate approximation of the actual damped vibration experienced by real structures, which always have more or less internal friction. In this report the behaviour of damped systems are only briefly described since the influences of damping is neglected in the following chapters.

4.2.2.1 Undamped free vibration

Consider a mass attached to a spring as illustrated in Figure 4.6 where the mass can move only in the vertical direction and therefore has only one degree of freedom. The unloaded equilibrium position for the system is noted as u_e and is the static equilibrium position when the dead weight is the only present load. u is the coordinate describing the distance from the unloaded equilibrium position to the current position. The mass M is attached to a spring with linear elastic behaviour with stiffness K . The stiffness factor K is equal to the force required to move the system a distance. The internal force R for a linear elastic system can be expressed as:

$$R = Ku \quad (4.18)$$

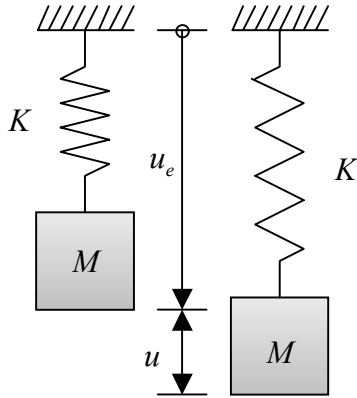

Figure 4.6 Mass undergoing undamped free vibration.

When the body is moved a distance u from the unloaded equilibrium position and then released, the system will undergo an undamped free vibration about the unloaded equilibrium position. The forces acting on the isolated body is shown in Figure 4.7 where Mg is the dead weight of the system.

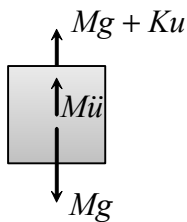

Figure 4.7 Forces acting on the mass in Figure 4.6.

Due to dynamic equilibrium conditions the sum of the forces shall be zero.

$$Mg - (Mg + Ku) - M\ddot{u} = 0 \quad (4.19)$$

where u varies in time i.e. $u=u(t)$.

By rearranging the terms in the equation above the differential equation of motion for an undamped system with linear elastic behaviour is defined as:

$$M\ddot{u} + Ku = 0 \quad (4.20)$$

Introducing the definition of the circular frequency $\omega = \sqrt{K/M}$ Equation (4.20) can be written as:

$$\ddot{u} + \omega^2 u = 0 \quad (4.21)$$

In a more general form the differential equation in Equation (4.20) can be written as:

$$M\ddot{u} + R = 0 \quad (4.22)$$

where the expression for the internal force R is depending on the material behaviour.

In expression (4.22) the internal force R is not necessarily given by a linear expression (such as Equation (4.18)) and generally it holds that $R \neq Ku$.

4.2.2.2 Undamped forced vibration

Still neglecting the frictional effects, consider again the system shown in Section 4.2.2.1. Now the system is subjected to an external dynamic load $P(t)$ as shown in Figure 4.8.

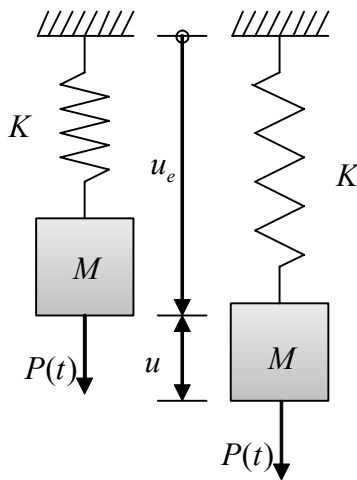

Figure 4.8 Mass undergoing undamped forced vibration.

The forces acting on the isolated body is shown in Figure 4.9.

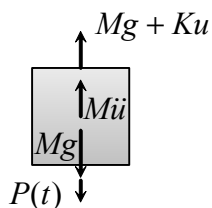

Figure 4.9 Forces acting on the mass in Figure 4.8.

Due to dynamic equilibrium conditions the sum of the forces shall be zero.

$$Mg + P(t) - (Mg + Ku) - M\ddot{u} = 0 \quad (4.23)$$

where the displacement u varies in time i.e. $u = u(t)$.

By rearranging the terms in the equation above the differential equation of motion for an undamped system with linear elastic behaviour subjected to a dynamic load is defined as:

$$M\ddot{u} + Ku = P(t) \quad (4.24)$$

In a more general form the differential equation can be written as:

$$M\ddot{u} + R = P(t) \quad (4.25)$$

where the expression for the internal force R is depending on the material behaviour, and again it generally holds that $R \neq Ku$.

4.2.2.3 Damped free vibration

Using the same notations as in the case of undamped free vibrations (see Section 4.2.2.1) but also taking the damping into consideration the differential equation of motion of a damped free system can be derived.

The system in Figure 4.10 where the damping of the system is noted as C is studied.

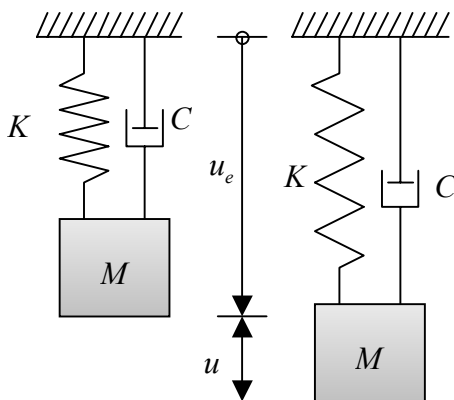

Figure 4.10 Mass undergoing damped free vibration.

When the body is moved a distance u from the unloaded equilibrium position and then released the system will undergo a damped free vibration about the unloaded equilibrium position. The forces acting on the isolated body is shown in Figure 4.11.

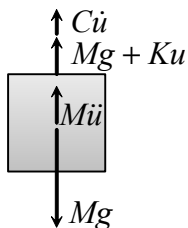

Figure 4.11 Forces acting on the mass in Figure 4.10.

Due to dynamic equilibrium conditions the sum of the forces shall be zero.

$$Mg - (Mg + Ku) - M\ddot{u} - C\dot{u} = 0 \quad (4.26)$$

where the displacement u varies in time i.e. $u=u(t)$.

By rearranging the terms in the equation above the differential equation of motion for a damped system with linear elastic behaviour is defined as:

$$M\ddot{u} + C\dot{u} + Ku = 0 \quad (4.27)$$

In a more general form the differential equation can be written as:

$$M\ddot{u} + C\dot{u} + R = 0 \quad (4.28)$$

where the expression for the internal force R is depending on the material behaviour, and generally $R \neq Ku$.

4.2.2.4 Damped forced vibration

Again consider the damped mass-spring system in Section 4.2.2.3 but now subjected to an external dynamic load $P(t)$ as shown in Figure 4.12.

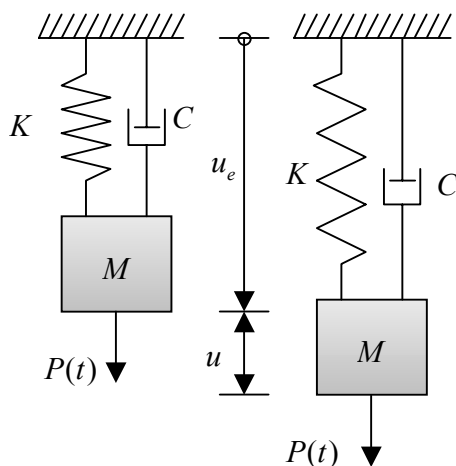

Figure 4.12 Mass undergoing damped forced vibration.

The forces acting on the isolated body is shown in Figure 4.13.

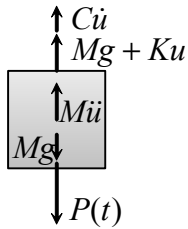

Figure 4.13 Forces acting on the mass in

Figure 4.12.

Due to dynamic equilibrium conditions the sum of the forces shall be zero:

$$Mg + P(t) - (Mg + Ku) - M\ddot{u} - C\dot{u} = 0 \quad (4.29)$$

where the displacement u varies in time, i.e. $u=u(t)$.

By rearranging the terms in the equation above the differential equation of motion for a damped system with linear elastic behaviour subjected to a dynamic load is defined as:

$$M\ddot{u} + C\dot{u} + Ku = P(t) \quad (4.30)$$

In a more general form the differential equation can be written as:

$$M\ddot{u} + C\dot{u} + R = P(t) \quad (4.31)$$

where the expression for the internal force R is depending on the material behaviour, and generally $R \neq Ku$.

4.2.3 Beam vibrations

The eigenfrequencies for a structure are the frequencies for which the structure will vibrate of its own accord when exposed to a perturbation. The shapes of the structure for the different eigenfrequencies are called eigenmodes where each eigenmode is related to one specific eigenfrequency.

Three different mode shapes, for a simply supported beam, are shown in Figure 4.14 where the first eigenmode corresponds to the lowest value of the eigenfrequency.

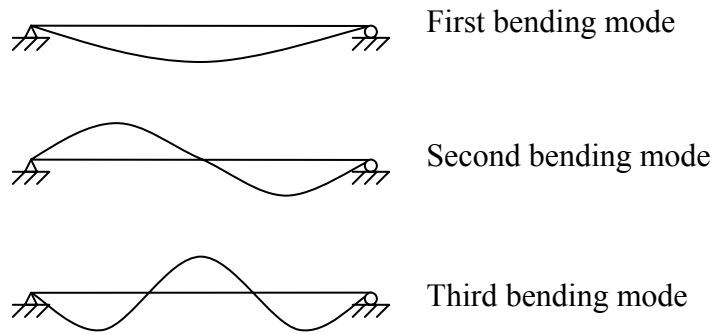

Figure 4.14 Eigenmodes for simply supported beam.

Normally, when a beam is subjected to a dynamic load, the frequency will not coincide with the eigenfrequencies and therefore the shape of deformation will not be the same as any of the eigenmodes. However, the dominating shape of deformation is the first eigenmode but it is influenced by higher modes. SDOF systems have only one eigenmode and hence there are no influences from higher modes.

5 Solution of equilibrium equations in dynamic analysis

The equations of motion derived in Section 4.2.2.1 to 4.2.2.4 can mathematically be solved by analytical procedures. However, these standard procedures, proposed for solving general systems of differential equations, can be very expensive since heavy equations and calculation are required. Therefore the use of more effective methods is motivated even though they give approximate results.

In this report two solution procedures are used where both are special cases of the Newmark method. The Newmark method is a direct integration solution method where the equations of motion are integrated using a numerical step-by-step procedure. By the term “direct” it is meant that no transformation of the equations into a different form is carried out before the numerical integration.

For a large structure where it is hard to find a solution that holds for the entire region the region is divided into smaller parts, so-called finite elements, for which the approximated solution is carried out over each element. Even though the searched variable is varying in a nonlinear manner over the entire region it may be a fair approximation to assume that the variable varies linearly over each element.

The stability of the Newmark method depends on the parameters α and δ , see Section 5.1. The so called central difference method is, according to Bathe (1996), a special case of Newmark, with $\alpha=0$ and $\delta=0.5$. The central difference method is a conditionally stable method meaning that the time step increment Δt must be smaller than a critical value of the time increment, Δt_{cr} , in order to generate a stable solution. If the time step increment is larger than Δt_{cr} the solution is unstable.

The differential equation of motion for a damped body subjected to an external dynamic load is the most general form of the equation of motion. For single degree of freedom systems the equation of motion is shown in Equation (4.31). In order to facilitate when using finite elements the differential equation can be written in matrix and vector form.

$$\mathbf{M}\ddot{\mathbf{U}} + \mathbf{C}\dot{\mathbf{U}} + \mathbf{R} = \mathbf{P} \quad (5.1)$$

\mathbf{M} , \mathbf{C} and \mathbf{R} are the notations for the matrices of mass, damping and internal force respectively. \mathbf{P} is the vector of externally applied loads and \mathbf{U} , $\dot{\mathbf{U}}$ and $\ddot{\mathbf{U}}$ are the displacement, velocity and acceleration vectors respectively. When analysing a mass-spring system with only one degree of freedom only one element is used. In the following the displacement, velocity and acceleration vectors at time 0, denoted as ${}^0\mathbf{U}$, ${}^0\dot{\mathbf{U}}$ and ${}^0\ddot{\mathbf{U}}$, respectively, are assumed to be known.

5.1 The Newmark method

In the Newmark method it is necessary to triangularize the stiffness matrix, see Bathe (1996). Only the case of linear elastic behaviour is discussed here, since other materials may give rather complex stiffness matrices to triangularize, however, the principle is the same.

In the Newmark method the acceleration and displacement at time $t+\Delta t$ are assumed to be:

$${}^{t+\Delta t}\dot{\mathbf{U}} = {}^t\dot{\mathbf{U}} + [(1-\delta){}^t\ddot{\mathbf{U}} + \delta{}^{t+\Delta t}\ddot{\mathbf{U}}]\Delta t \quad (5.2)$$

$${}^{t+\Delta t}\mathbf{U} = {}^t\mathbf{U} + {}^t\dot{\mathbf{U}}\Delta t + \left[\left(\frac{1}{2}-\alpha\right){}^t\ddot{\mathbf{U}} + \alpha{}^{t+\Delta t}\ddot{\mathbf{U}}\right]\Delta t^2 \quad (5.3)$$

where α and δ are parameters that can be determined to obtain integration accuracy and stability. When setting $\alpha=0.25$ and $\delta=0.5$ in the Newmark method you get, according to Bathe (1996) the constant-average-acceleration method (or trapezoidal rule), illustrated in Figure 5.1.

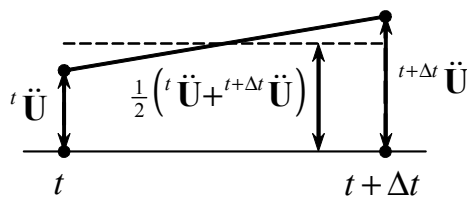

Figure 5.1 Newmark method with $\alpha=0.25$ and $\delta=0.5$.

In case of linear elastic material the internal force at time $t+\Delta t$ can be written as:

$${}^{t+\Delta t}\mathbf{R} = \mathbf{K}{}^{t+\Delta t}\mathbf{U} \quad (5.4)$$

where \mathbf{K} is the stiffness matrix.

By using Equation (5.4) the equation of motion in Equation (5.1) can be expressed as:

$$\mathbf{M}\ddot{\mathbf{U}} + \mathbf{C}\dot{\mathbf{U}} + \mathbf{K}\mathbf{U} = \mathbf{P} \quad (5.5)$$

The equation of motion at time $t+\Delta t$ is:

$$\mathbf{M}{}^{t+\Delta t}\ddot{\mathbf{U}} + \mathbf{C}{}^{t+\Delta t}\dot{\mathbf{U}} + \mathbf{K}{}^{t+\Delta t}\mathbf{U} = {}^{t+\Delta t}\mathbf{P} \quad (5.6)$$

By rearranging the terms in Equation (5.3) the acceleration at time $t+\Delta t$ can be expressed as:

$${}^{t+\Delta t}\ddot{\mathbf{U}} = \frac{1}{\alpha\Delta t^2}({}^{t+\Delta t}\mathbf{U} - {}^t\mathbf{U}) - \frac{1}{\alpha\Delta t}{}^t\dot{\mathbf{U}} - \frac{1}{2\alpha}{}^t\ddot{\mathbf{U}} + {}^t\ddot{\mathbf{U}} \quad (5.7)$$

By substituting Equation (5.7) into Equation (5.2) the expression for the velocity at time $t+\Delta t$ are found. The relations for the acceleration and velocity at time $t+\Delta t$ are used in the equation of motion (see Equation (5.6)) in order to solve for the displacement at time $t+\Delta t$. The complete algorithm for the Newmark method, according to Bathe (1996) is given in Table 5.1 below.

Table 5.1 Algorithm for Newmark method when having linear elastic behaviour, according to Bathe (1996).

<p>A. Initial calculations:</p> <p>a. Form stiffness matrix \mathbf{K}, mass matrix \mathbf{M} and damping matrix \mathbf{C}.</p> <p>b. Initialize ${}^0\mathbf{U}$, ${}^0\dot{\mathbf{U}}$ and ${}^0\ddot{\mathbf{U}}$.</p> <p>c. Select time step Δt and parameters α and δ to calculate integration constants:</p> $\delta \geq 0.50 \quad \alpha \geq 0.25(0.5 + \delta)^2$ $a_0 = \frac{1}{\alpha \Delta t^2} \quad a_1 = \frac{\delta}{\alpha \Delta t} \quad a_2 = \frac{1}{\alpha \Delta t} \quad a_3 = \frac{1}{2\alpha} - 1$ $a_4 = \frac{\delta}{\alpha} - 1 \quad a_5 = \frac{\Delta t}{2} \left(\frac{\delta}{\alpha} - 2 \right) \quad a_6 = \Delta t(1 - \delta) \quad a_7 = \delta \Delta t$ <p>d. Form effective stiffness matrix $\hat{\mathbf{K}}$.</p> $\hat{\mathbf{K}} = \mathbf{K} + a_0\mathbf{M} + a_1\mathbf{C}$			
<hr/> <p>B. For each time step:</p> <p>a. Calculate effective loads at time $t + \Delta t$.</p> ${}^{t+\Delta t}\hat{\mathbf{P}} = {}^{t+\Delta t}\mathbf{P} + \mathbf{M}(a_0 {}^t\mathbf{U} + a_2 {}^t\dot{\mathbf{U}} + a_3 {}^t\ddot{\mathbf{U}}) + \mathbf{C}(a_1 {}^t\mathbf{U} + a_4 {}^t\dot{\mathbf{U}} + a_5 {}^t\ddot{\mathbf{U}})$ <p>b. Solve for displacements at time $t + \Delta t$.</p> $\hat{\mathbf{K}} {}^{t+\Delta t}\mathbf{U} = {}^{t+\Delta t}\hat{\mathbf{P}}$ <p>c. Calculate accelerations and velocities at time $t + \Delta t$.</p> ${}^{t+\Delta t}\ddot{\mathbf{U}} = a_0 ({}^{t+\Delta t}\mathbf{U} - {}^t\mathbf{U}) - a_2 {}^t\dot{\mathbf{U}} - a_3 {}^t\ddot{\mathbf{U}}$ ${}^{t+\Delta t}\dot{\mathbf{U}} = {}^t\dot{\mathbf{U}} + a_6 {}^t\ddot{\mathbf{U}} + a_7 {}^{t+\Delta t}\ddot{\mathbf{U}}$			

5.2 The central difference method

When $\alpha=0$ and $\delta=0.5$ are chosen the central difference method is obtained, according to Bathe (1996). In the central difference method it is assumed that the acceleration for time t can be written as:

$${}^t\ddot{\mathbf{U}} = \frac{1}{\Delta t^2} ({}^{t-\Delta t}\mathbf{U} - 2{}^t\mathbf{U} + {}^{t+\Delta t}\mathbf{U}) \quad (5.8)$$

The velocity expression is written as:

$${}^t\dot{\mathbf{U}} = \frac{1}{2\Delta t} ({}^{t-\Delta t}\mathbf{U} + {}^{t+\Delta t}\mathbf{U}) \quad (5.9)$$

The displacement at time $t+\Delta t$ is obtained by considering the equation of motion see Equation (5.1) at time t , i.e.:

$$\mathbf{M}'\ddot{\mathbf{U}} + \mathbf{C}'\dot{\mathbf{U}} + {}^t\mathbf{R} = {}^t\mathbf{P} \quad (5.10)$$

Since the equations are set up in a known state it is an explicit method.

By using Equations (5.8) and (5.9) Equation (5.10) can be written as:

$$\left(\frac{1}{\Delta t^2} \mathbf{M} + \frac{1}{2\Delta t} \mathbf{C} \right) {}^{t+\Delta t}\mathbf{U} = {}^t\mathbf{P} - {}^t\mathbf{R} + \frac{2}{\Delta t^2} \mathbf{M}'\mathbf{U} - \left(\frac{1}{\Delta t^2} \mathbf{M} - \frac{1}{2\Delta t} \mathbf{C} \right) {}^{t-\Delta t}\mathbf{U} \quad (5.11)$$

The displacement at time $t+\Delta t$ can now be solved but the solving algorithm is slightly different for different material responses.

In the very beginning of the calculations ${}^0\mathbf{U}$, ${}^0\dot{\mathbf{U}}$ and ${}^0\ddot{\mathbf{U}}$ are initialized but also the value of ${}^{0-\Delta t}\mathbf{U}$ is required in order to calculate ${}^{0+\Delta t}\mathbf{U}$ (see Equation(5.11)). The displacement at time $0-\Delta t$ can be expressed by means of displacement, velocity and acceleration at time 0. For sufficiently small Δt the change of displacement during the time Δt is:

$${}^{0-\Delta t}\mathbf{U} = {}^0\mathbf{U} - \Delta t \cdot {}^0\dot{\mathbf{U}} + \frac{\Delta t^2}{2} {}^0\ddot{\mathbf{U}} \quad (5.12)$$

In order to use less storage space and less processing time the consistent mass matrix can be reduced to one with a more manageable size and structure. The preferable structure is a diagonal matrix as shown in Equation (5.13), called a lumped (or effective) mass matrix.

$$\mathbf{M} = \begin{bmatrix} M_1 & 0 & \cdot & 0 \\ 0 & M_2 & \cdot & 0 \\ \cdot & \cdot & \cdot & \cdot \\ 0 & 0 & \cdot & M_n \end{bmatrix} \quad (5.13)$$

Different methods can be used to transform the consistent mass matrix and obtain a diagonal matrix, one of them is HRZ lumping. However this is not discussed here but further information can be found in KTH (2006).

5.2.1 Linear elastic material

A material response curve linear elastic material can be seen in Figure 5.2.

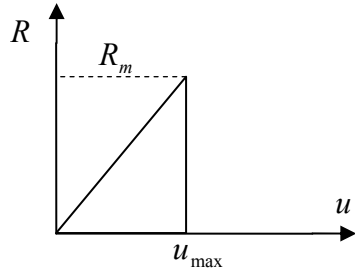

Figure 5.2 Material response curve for linear elastic material.

In case of linear elastic material the internal force at time t can be written as:

$${}^t\mathbf{R} = \mathbf{K} {}^t\mathbf{U} \quad (5.14)$$

where \mathbf{K} is the stiffness matrix see also Section 3.1.1.

Substituting Equation (5.14) into Equation (5.11) gives:

$$\left(\frac{1}{\Delta t^2} \mathbf{M} + \frac{1}{2\Delta t} \mathbf{C} \right) {}^{t+\Delta t} \mathbf{U} = {}^t \mathbf{P} - \left(\mathbf{K} - \frac{2}{\Delta t^2} \mathbf{M} \right) {}^t \mathbf{U} - \left(\frac{1}{\Delta t^2} \mathbf{M} - \frac{1}{2\Delta t} \mathbf{C} \right) {}^{t-\Delta t} \mathbf{U} \quad (5.15)$$

Equation (5.15) can be written as:

$$\hat{\mathbf{M}} {}^{t+\Delta t} \mathbf{U} = {}^t \hat{\mathbf{P}} \quad (5.16)$$

Where

$$\hat{\mathbf{M}} = \frac{1}{\Delta t^2} \mathbf{M} + \frac{1}{2\Delta t} \mathbf{C} \quad (5.17)$$

and

$${}^t \hat{\mathbf{P}} = {}^t \mathbf{P} - \left(\mathbf{K} - \frac{2}{\Delta t^2} \mathbf{M} \right) {}^t \mathbf{U} - \left(\frac{1}{\Delta t^2} \mathbf{M} - \frac{1}{2\Delta t} \mathbf{C} \right) {}^{t-\Delta t} \mathbf{U} \quad (5.18)$$

The displacement at time $t+\Delta t$ is calculated by use of Equation (5.16) as:

$${}^{t+\Delta t} \mathbf{U} = \hat{\mathbf{M}}^{-1} {}^t \hat{\mathbf{P}} \quad (5.19)$$

The time increment Δt must be smaller than a critical value of the time increment, Δt_{cr} , which can be calculated from the mass and stiffness properties of the complete element assemblage. For linear problems, this critical time step Δt_{cr} is:

$$\Delta t_{cr} = \frac{2}{\omega_{\max}} \quad (5.20)$$

where ω_{\max} is the maximum eigenfrequency, bounded by the maximum frequency of the individual finite elements.

Since $\hat{\mathbf{M}}$ does not varies in time, for linear elastic material (see Equation (5.17)), it is calculated only in the initial stage of the analysis together with the stiffness matrix \mathbf{K} , mass matrix \mathbf{M} and damping matrix \mathbf{C} (if not neglected). The values of the displacement, velocity and acceleration at time 0, noted ${}^0\mathbf{U}$, ${}^0\dot{\mathbf{U}}$ and ${}^0\ddot{\mathbf{U}}$ respectively, are also initialized in the initial stage and after selecting time step size the displacement at time $-\Delta t$ are calculated by means of Equation (5.12). Since $\hat{\mathbf{P}}$ varies in time it has to be calculated for each time step in the analysis and for each time the displacement is calculated by means of Equation (5.19).

The complete algorithm, according to Bathe (1996), for the central difference method when having a linear elastic material is given in Table 5.2.

Table 5.2 Algorithm for central difference method when having linear elastic behaviour according to Bathe (1996).

A. Initial calculations:

- a. Form stiffness matrix \mathbf{K} , mass matrix \mathbf{M} and damping matrix \mathbf{C} .
- b. Initialize ${}^0\mathbf{U}$, ${}^0\dot{\mathbf{U}}$ and ${}^0\ddot{\mathbf{U}}$.
- c. Select time step Δt ($\Delta t \leq \Delta t_{cr}$).
- d. Calculate ${}^{-\Delta t}\mathbf{U} = {}^0\mathbf{U} - \Delta t {}^0\dot{\mathbf{U}} + \frac{\Delta t^2}{2} {}^0\ddot{\mathbf{U}}$
- e. Form effective mass matrix $\hat{\mathbf{M}}$.

$$\hat{\mathbf{M}} = \frac{1}{\Delta t^2} \mathbf{M} + \frac{1}{2\Delta t} \mathbf{C}$$

B. For each time step:

- a. Calculate effective loads at time t .

$${}^t\hat{\mathbf{P}} = {}^t\mathbf{P} - \left(\mathbf{K} - \frac{2}{\Delta t^2} \mathbf{M} \right) {}^t\mathbf{U} - \left(\frac{1}{\Delta t^2} \mathbf{M} - \frac{1}{2\Delta t} \mathbf{C} \right) {}^{t-\Delta t}\mathbf{U}$$

- b. Solve for displacements at time $t + \Delta t$.

$$\hat{\mathbf{M}} {}^{t+\Delta t}\mathbf{U} = {}^t\hat{\mathbf{P}}$$

- c. If required evaluate accelerations and velocities at time t .

$${}^t\ddot{\mathbf{U}} = \frac{1}{\Delta t^2} \left({}^{t-\Delta t}\mathbf{U} - 2{}^t\mathbf{U} + {}^{t+\Delta t}\mathbf{U} \right)$$

$${}^t\dot{\mathbf{U}} = \frac{1}{2\Delta t} \left(-{}^{t-\Delta t}\mathbf{U} + {}^{t+\Delta t}\mathbf{U} \right)$$

5.2.2 Ideal plastic material

A material response curve for ideal plastic material can be seen in Figure 5.3.

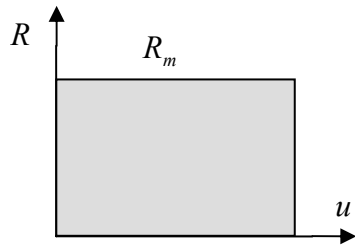

Figure 5.3 Material response curve for ideal plastic material.

The internal force R equals to the maximum value R_m if the external load is higher than the maximum value of the internal force or if the displacement is larger than zero. If the external load is lower than the maximum value of the internal force and there are no displacements the internal force will be equal to the external load. (See also Section 3.1.2).

$$\begin{aligned} {}^t\mathbf{R} &= \mathbf{R}_m && \text{when } {}^t\mathbf{P} \geq \mathbf{R}_m \text{ or } {}^t\mathbf{U} \neq 0 \\ {}^t\mathbf{R} &= {}^t\mathbf{P} && \text{when } {}^t\mathbf{P} < \mathbf{R}_m \text{ if also } {}^t\mathbf{U} = 0 \end{aligned} \quad (5.21)$$

where \mathbf{R}_m is the maximum value of the internal force and ${}^t\mathbf{P}$ is the external load matrix at time t .

The equation of motion in Equation (5.1) at time t is then:

$$\begin{aligned} \mathbf{M}^t \ddot{\mathbf{U}} + \mathbf{C}^t \dot{\mathbf{U}} + \mathbf{R}_m &= {}^t\mathbf{P} && \text{when } {}^t\mathbf{P} \geq \mathbf{R}_m \text{ or } {}^t\mathbf{U} \neq 0 \\ \mathbf{M}^t \ddot{\mathbf{U}} + \mathbf{C}^t \dot{\mathbf{U}} &= \mathbf{0} && \text{when } {}^t\mathbf{P} < \mathbf{R}_m \text{ if also } {}^t\mathbf{U} = 0 \end{aligned} \quad (5.22)$$

Equation (5.11) can in case of ideal plastic material written as:

$$\left(\frac{1}{\Delta t^2} \mathbf{M} + \frac{1}{2\Delta t} \mathbf{C} \right)^{t+\Delta t} \mathbf{U} = {}^t\mathbf{P} - {}^t\mathbf{R} + \frac{2}{\Delta t^2} \mathbf{M}^t \mathbf{U} - \left(\frac{1}{\Delta t^2} \mathbf{M} - \frac{1}{2\Delta t} \mathbf{C} \right)^{t-\Delta t} \mathbf{U} \quad (5.23)$$

Equation (5.23) can be written as:

$$\hat{\mathbf{M}}^{t+\Delta t} \mathbf{U} = {}^t\hat{\mathbf{P}} \quad (5.24)$$

where

$$\hat{\mathbf{M}} = \frac{1}{\Delta t^2} \mathbf{M} + \frac{1}{2\Delta t} \mathbf{C} \quad (5.25)$$

and

$${}^t\hat{\mathbf{P}} = {}^t\mathbf{P} - {}^t\mathbf{R} + \frac{2}{\Delta t^2}\mathbf{M}{}^t\mathbf{U} - \left(\frac{1}{\Delta t^2}\mathbf{M} - \frac{1}{2\Delta t}\mathbf{C} \right) {}^{t-\Delta t}\mathbf{U} \quad (5.26)$$

The displacement at time $t+\Delta t$ is calculated by use of Equation (5.24).

$${}^{t+\Delta t}\mathbf{U} = \hat{\mathbf{M}}^{-1} {}^t\hat{\mathbf{P}} \quad (5.27)$$

In Equations (5.26) it is seen that as long as the external load is lower than the maximum value of the internal force and the displacement and acceleration for time t and $t-\Delta t$ respectively is zero there will be no motion since ${}^t\hat{\mathbf{P}}$ becomes zero giving that ${}^{t+\Delta t}\mathbf{U}$, calculated as in Equation (5.27), becomes zero.

Since $\hat{\mathbf{M}}$ does not varies in time for ideal plastic material, see Equation (5.25), it is calculated only in the initial stage of the analysis together with the stiffness matrix \mathbf{K} , mass matrix \mathbf{M} and damping matrix \mathbf{C} (if not neglected). The values of the displacement, velocity and acceleration at time $t=0$, denoted ${}^0\mathbf{U}$, ${}^0\dot{\mathbf{U}}$ and ${}^0\ddot{\mathbf{U}}$ respectively, are also initialized in the initial stage and after selecting time step size the displacement at time $-\Delta t$ are calculated by means of Equation (5.27). Since \mathbf{R} depends on the size of the load and the displacement it must be calculated for each time step, see Equation (5.21). Also $\hat{\mathbf{P}}$ varies in time and has to be calculated for each time step in the analysis, see Equation (5.26) and the displacement at time $t+\Delta t$ is calculated by means of Equation (5.27).

The complete algorithm for the central difference method when having an ideal plastic material is given in Table 5.3.

Table 5.3 Algorithm for central difference method when having ideal plastic behaviour.

<p>A. Initial calculations:</p> <ol style="list-style-type: none"> Form mass matrix \mathbf{M} and damping matrix \mathbf{C}. Initialize ${}^0\mathbf{U}$, ${}^0\dot{\mathbf{U}}$ and ${}^0\ddot{\mathbf{U}}$. Select time step Δt ($\Delta t \leq \Delta t_{cr}$). Calculate ${}^{-\Delta t}\mathbf{U} = {}^0\mathbf{U} - \Delta t {}^0\dot{\mathbf{U}} + \frac{\Delta t^2}{2} {}^0\ddot{\mathbf{U}}$ Form effective mass matrix $\hat{\mathbf{M}}$. $\hat{\mathbf{M}} = \frac{1}{\Delta t^2}\mathbf{M} + \frac{1}{2\Delta t}\mathbf{C}$ <hr/> <p>B. For each time step:</p> <ol style="list-style-type: none"> Determine the matrix of internal force for time t. ${}^t\mathbf{R} = \mathbf{R}_m \quad \text{when } {}^t\mathbf{P} \geq \mathbf{R}_m \quad \text{or } {}^t\mathbf{U} \neq 0$ ${}^t\mathbf{R} = {}^t\mathbf{P} \quad \text{when } {}^t\mathbf{P} < \mathbf{R}_m \quad \text{if also } {}^t\mathbf{U} = 0$ Calculate effective loads at time t. ${}^t\hat{\mathbf{P}} = {}^t\mathbf{P} - {}^t\mathbf{R} + \frac{2}{\Delta t^2}\mathbf{M}{}^t\mathbf{U} - \left(\frac{1}{\Delta t^2}\mathbf{M} - \frac{1}{2\Delta t}\mathbf{C} \right) {}^{t-\Delta t}\mathbf{U}$ Solve for displacements at time $t + \Delta t$. $\hat{\mathbf{M}}{}^{t+\Delta t}\mathbf{U} = {}^t\hat{\mathbf{P}}$ If required evaluate accelerations and velocities at time t. ${}^t\ddot{\mathbf{U}} = \frac{1}{\Delta t^2} ({}^{t-\Delta t}\mathbf{U} - 2{}^t\mathbf{U} + {}^{t+\Delta t}\mathbf{U})$ ${}^t\dot{\mathbf{U}} = \frac{1}{2\Delta t} (-{}^{t-\Delta t}\mathbf{U} + {}^{t+\Delta t}\mathbf{U})$

6 Transformation from deformable body to SDOF system

In order to simplify analyses of deformable bodies, which have an infinite number of degrees of freedom, the system can be discretized to a system with a finite number of elements and the degrees of freedom belonging to them. Beams and plates have, in practice, a limited possibility to move. This makes it possible to transform the structures to single degree of freedom systems here denoted as SDOF systems, see Figure 6.1. This simplification introduces errors into the analyses. For example the user assumes a shape of deflection valid for the SDOF system, in this report the shape of deformation corresponding to the first eigenmode is assumed, while the shape of deformation for beams are influenced by higher modes, see Section 4.2.3.

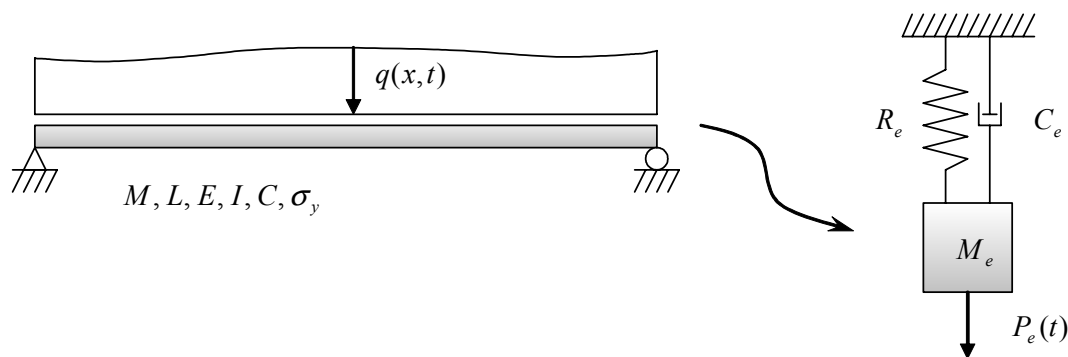

Figure 6.1 Transformation from deformable body to SDOF system.

The properties of the deformable body will be transformed to the SDOF system by assigning equivalent quantities for the mass, the internal force and the load applied to a system point. The SDOF system is assumed to have the same function describing the deflection in the system point. Since, in most cases, the maximum displacement is to be calculated the location of the system point in the deformable body is chosen to coincide with the point that achieves the largest displacement but it can be an arbitrary point along the beam. One condition, for the transformation of the properties to be possible, is that a uniform change of the deformation is assumed. That is if the displacement in one point of the beam increases the displacements in all the other points will increase proportional to this as illustrated in Figure 6.2. Another way to express this is to say that the principle shape of deformation is assumed to be the same, and hence be known at all times.

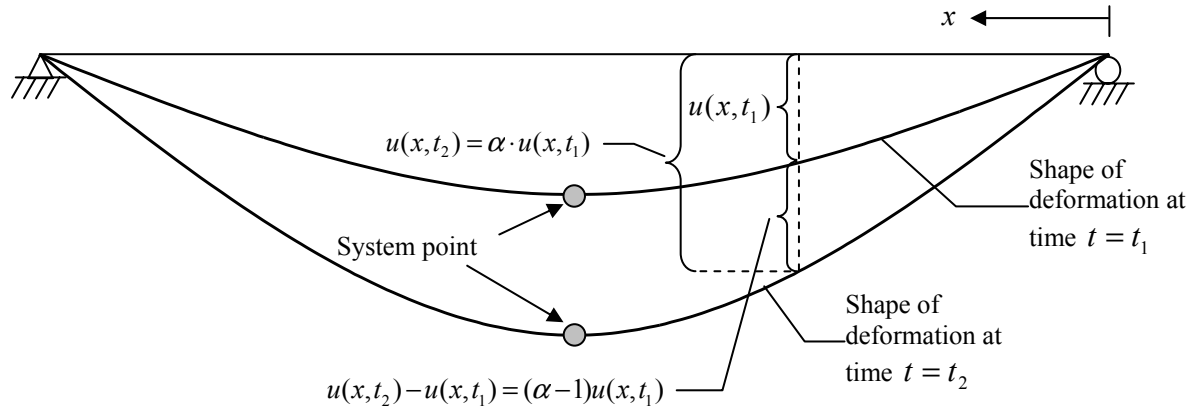

Figure 6.2 Shape of deformation at time t_1 and t_2 .

The transformation of the properties for the real structure to the equivalent properties for the SDOF system is made by use of transformation factors. The equivalent quantities and the transformation factors are derived from the condition that the energy exerted by the equivalent SDOF system must be equal to the energy exerted by the beam, when exposed to a certain load. Hence, the transformation factors will depend on the applied load and the deflection shape of the beam.

6.1 Differential equation for SDOF system

The differential equation for the SDOF system in Figure 6.1 is:

$$M_e \ddot{u}_s + C_e \dot{u}_s + R_e = P_e(t) \quad (6.1)$$

where M_e is the equivalent mass, R_e is the equivalent internal force and $P_e(t)$ is the equivalent load applied which is varying with time. The damping, C_e , of the system is here chosen to be neglected since it has little influence on the value of the maximum displacement which is of interest. Neglecting the influences of damping also involves calculations that are easier to handle and gives results on the safe side because the capacity of the system is underestimated. When neglecting the damping the differential equation for the SDOF system in Equation (6.1) can be rewritten as:

$$M_e \ddot{u}_s + R_e = P_e(t) \quad (6.2)$$

The equivalent quantities for the mass, the internal force and the load can be expressed by means of transformation factors.

$$\kappa_M M \ddot{u}_s + \kappa_K R = \kappa_P P(t) \quad (6.3)$$

Equation (6.2) and (6.3) gives the definition of the transformation factors.

$$\kappa_M = \frac{M_e}{M} \quad (6.4)$$

$$\kappa_K = \frac{R_e}{R} \quad (6.5)$$

$$\kappa_P = \frac{P_e(t)}{P(t)} \quad (6.6)$$

In order to simplify the expression of the differential equation further two new transformation factors are defined.

$$\kappa_{MP} = \frac{\kappa_M}{\kappa_P} \quad (6.7)$$

$$\kappa_{KP} = \frac{\kappa_K}{\kappa_P} \quad (6.8)$$

By use of Equations (6.3), (6.7) and (6.8) the differential equation for the SDOF system can be expressed as:

$$\kappa_{MP} M \ddot{u}_s + \kappa_{KP} R = P(t) \quad (6.9)$$

6.2 Transformation factors for beams

6.2.1 Transformation factor for the mass

The transformation factor for the mass can be derived from the condition that the equivalent mass M_e , following the oscillation of the system point u_s , shall generate the same amount of kinetic energy as the real system.

The kinetic energy generated by the equivalent mass in the SDOF system is:

$$W_k^{SDOF} = \frac{M_e v_s^2}{2} \quad (6.10)$$

where $v_s = \frac{\Delta u_s}{\Delta t}$ is the velocity of the system point in vertical direction.

The kinetic energy for the beam is:

$$W_k^{beam} = \int_{x=0}^{x=L} \frac{v^2}{2} \rho A dx \quad (6.11)$$

where	x	coordinate with origin in one end of the beam	[m]
	A	cross-section area	[m ²]
	ρ	density	[kg/m ³]
	$v = v(x) = \frac{\Delta u}{\Delta t}$	velocity of arbitrary point in vertical direction	[m/s]

Due to the statement above Equation (6.10) shall be equal to Equation (6.11), i.e.:

$$\frac{M_e v_s^2}{2} = \int_{x=0}^{x=L} \frac{v^2}{2} \rho A dx \Leftrightarrow M_e = \int_{x=0}^{x=L} \frac{v^2}{v_s^2} \rho A dx \quad (6.12)$$

The change of the displacement in an arbitrary point in the beam can be expressed as:

$$\Delta u = u(x, t_2) - u(x, t_1) = \alpha u(x, t_1) - u(x, t_1) = (\alpha - 1)u(x, t_1) \quad (6.13)$$

where $u(x, t_1)$ is the displacement at time $t=t_1$ at the distance x from one end of the beam and $u(x, t_2)$ is the displacement at the same position in the longitudinal direction of the beam at time $t=t_2$. Due to the constant shape of the beam deflection $u(x, t_2)$ can be said to be a factor α times larger than $u(x, t_1)$, see Figure 6.2.

This is also valid for the system point where the change of deformation when time goes from t_1 to t_2 thus can be expressed as, see Figure 6.2:

$$\Delta u_s = u_s(t_2) - u_s(t_1) = \alpha u_s(t_1) - u_s(t_1) = (\alpha - 1)u_s(t_1) \quad (6.14)$$

Since the assumption of uniform deformation is valid for all times, t , Equations (6.13) and (6.14) can be written in a more general form:

$$\Delta u = (\alpha - 1)u(x, t) \quad (6.15)$$

$$\Delta u_s = (\alpha - 1)u_s(t) \quad (6.16)$$

The velocity of an arbitrary point in vertical direction and the velocity of the system point in the same direction can be expressed as $v = \Delta u / \Delta t$ and $v_s = \Delta u_s / \Delta t$ respectively. Using these expressions together with Equation (6.15) and (6.16), Equation (6.12) can be written as:

$$M_e = \int_{x=0}^{x=L} \frac{((\alpha - 1)u(x, t))^2}{((\alpha - 1)u_s(t))^2} \rho A dx = \int_{x=0}^{x=L} \frac{u(x, t)^2}{u_s(t)^2} \rho A dx \quad (6.17)$$

If the definition of the transformation factor κ_M (see Equation (6.4)) is used and the beam is assumed to have a uniformly distributed mass the expression for the transformation factor for the mass can be written as:

$$\kappa_M = \frac{1}{M} \int_{x=0}^{x=L} \left(\frac{u(x,t)}{u_s(t)} \right)^2 \rho A dx = \frac{1}{L} \int_{x=0}^{x=L} \left(\frac{u(x,t)}{u_s(t)} \right)^2 dx \quad (6.18)$$

i.e. the transformation factor for the mass is depending on the assumed shape of the deformation.

6.2.2 Transformation factor for the load

The transformation factor for the load can be derived from the condition that the equivalent load, following the oscillation of the system point, shall generate the same amount of work as the total real load does in the real MDOF system.

The work generated by the equivalent load in the SDOF system during a time increment Δt is:

$$\Pi^{SDOF} = P_e(t)u_s(t) \quad (6.19)$$

The corresponding work for the beam is:

$$\Pi^{beam} = \int_{x=0}^{x=L} q(x,t)u(x,t)dx \quad (6.20)$$

where x coordinate with origin at one end of the beam [m]

$$\int_{x=0}^{x=L} q(x,t)dx = P(t) \quad \text{total load on the beam} \quad [\text{N}]$$

Due to the statement above Equation (6.19) shall be equal to Equation (6.20)

$$P_e(t)u_s(t) = \int_{x=0}^{x=L} q(x,t)u(x,t)dx \Leftrightarrow P_e(t) = \int_{x=0}^{x=L} q(x,t) \frac{u(x,t)}{u_s(t)} dx \quad (6.21)$$

The transformation factor for the load, see Equation (6.6), can now be written as:

$$\kappa_P = \frac{\int_{x=0}^{x=L} \frac{u(x,t)}{u_s(t)} q(x,t)dx}{\int_{x=0}^{x=L} q(x,t)dx} \quad (6.22)$$

Also the transformation factor for the external load is depending on the assumed shape of deformation. It is further depending on the shape of the load.

6.2.3 Transformation factor for internal force

The transformation factor for the internal force, following the oscillation of the system point, can be derived from the condition that the equivalent internal force shall perform a work that is equivalent to the work of deformation for the beam.

The internal force and the work it performs are depending on the behaviour of the material. For the SDOF system this is shown in Figure 6.3, where the shaded areas represent the total internal work for each material. R_{me} is the maximum value of the equivalent internal force. In case of linear elastic material the maximum internal force is corresponding to $R_{me} = K_e \cdot u_{s,max}$.

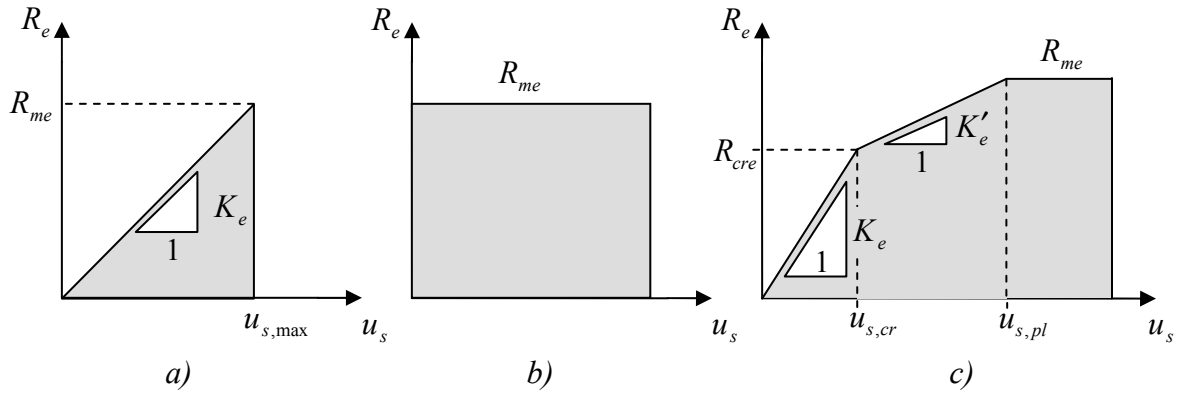

Figure 6.3 Internal work for SDOF system for a) Linear elastic material b) ideal plastic material c) trilinear material.

The internal force for the SDOF system can be expressed for the three different types of spring relations shown in Figure 6.3.

Linear elastic behaviour:

$$R_e = K_e u_s \quad (6.23)$$

where K_e is the stiffness of the linear spring in the SDOF system.

Ideal plastic behaviour:

$$R_e = R_{me} \quad \text{for } u(t) \neq 0 \quad (6.24)$$

Because of the ideal plastic behaviour there will be no displacement until the load, $P_e(t)$, has reached the value of the maximal internal force, R_{me} .

Trilinear behaviour:

$$R_e = \begin{cases} K_e u_s & \text{for } u_s \leq u_{s,cr} \\ K_e u_{s,cr} + K'_e (u_s - u_{s,cr}) & \text{for } u_{s,cr} \leq u_s \leq u_{s,pl} \\ R_{me} & \text{for } u_{s,pl} < u_s \end{cases} \quad (6.25)$$

6.2.3.1 Linear elastic material

Following Samuelsson and Wiberg (1999) the work of deformation for the beam made of linear elastic material can be derived by studying a lamella of length Δx and the sectional forces, \mathbf{N} , and deformations, $\Delta \mathbf{n}$, belonging to it, see Figure 6.4.

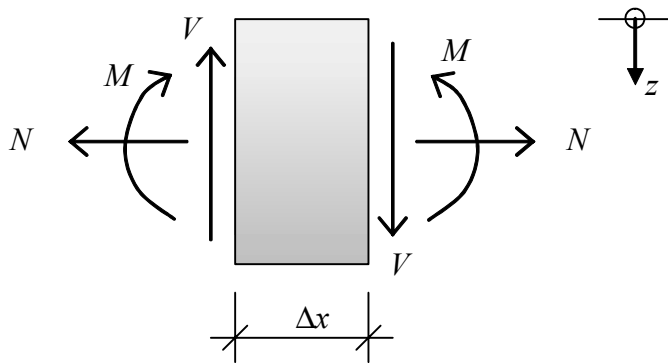

Figure 6.4 Segment, with length Δx , of the beam.

The constitutive relationship between the sectional forces \mathbf{N} and the deformations $\Delta \mathbf{n}$ are:

$$\mathbf{N} = \frac{1}{\Delta x} \begin{bmatrix} EA & 0 & 0 \\ 0 & GA/\beta & 0 \\ 0 & 0 & EI \end{bmatrix} \Delta \mathbf{n} \quad \mathbf{N} = \begin{bmatrix} N \\ V \\ M \end{bmatrix}, \quad \Delta \mathbf{n} = \begin{bmatrix} \Delta n \\ \Delta t \\ \Delta m \end{bmatrix} \quad (6.26)$$

where	E	modulus of elasticity	[Pa]
	A	cross-section area	[m ²]
	$G = \frac{E}{2(1+\nu)}$	shear modulus	[Pa]
	ν	Poisson's ratio	[-]
	β	constant, shape factor	[-]
	I	moment of inertia	[m ⁴]

The meanings of the deformations Δn , Δt and Δm are shown in Figure 6.5.

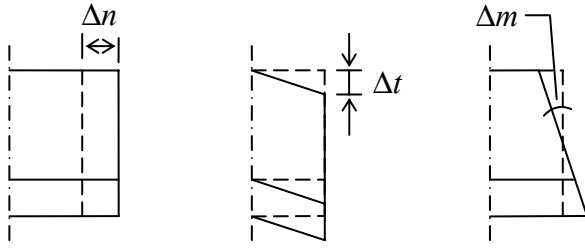

Figure 6.5 Deformation of beam lamella.

The constant β can be derived from the statement that the work of deformation due to shear force shall be equal to the work of deformation due to shear stress.

$$V\bar{\gamma} = V \frac{V\beta}{GA} = \int_{z=0}^{z=h} \tau(z)\gamma(z)b(z)dz \quad (6.27)$$

where $\bar{\gamma} = \frac{V\beta}{GA}$ average value of shear angle [-]

τ shear stress [Pa]

b width of the cross-section [m]

h height of the cross-section [m]

$\gamma = \frac{\tau}{G}$ shear angle [-]

For a certain time in the loading the sectional forces will increase from \mathbf{N} to $\mathbf{N} + d\mathbf{N}$ and the deformations will increase from $\Delta\mathbf{n}$ to $\Delta\mathbf{n} + d\Delta\mathbf{n}$. The change of the work of deformation is defined as the change of the work during the change of deformation $d\Delta\mathbf{n}$.

$$d\Pi_i^s = Nd\Delta\mathbf{n} + Vd\Delta t + Md\Delta m \quad (6.28)$$

where index s and i stands for segment and internal respectively.

When using Hooke's law Equation (6.28) can be rewritten

$$d\Pi_i^s = \frac{EA}{\Delta x} \Delta\mathbf{n} \cdot d\Delta\mathbf{n} + \frac{GA}{\beta\Delta x} \Delta t \cdot d\Delta t + \frac{EI}{\Delta x} \Delta m \cdot d\Delta m = \mathbf{N}^t d\Delta\mathbf{n} \quad (6.29)$$

In order to get the total work of deformation of the segment, Equation (6.29) will be integrated over the deformation $\Delta\mathbf{n}$.

$$\begin{aligned}\Pi_i^s &= \int_{\Delta n=0}^{\Delta n} \frac{EA}{\Delta x} \Delta n d\Delta n + \int_{\Delta t=0}^{\Delta t} \frac{GA}{\beta \Delta x} \Delta t d\Delta t + \int_{\Delta m=0}^{\Delta m} \frac{EI}{\Delta x} \Delta m d\Delta m = \\ &= \left(EA(\Delta n)^2 + \frac{GA}{\beta} (\Delta t)^2 + EI(\Delta m)^2 \right) \frac{1}{2\Delta x}\end{aligned}\quad (6.30)$$

Once again using Hooke's law and integrating the work of deformation for the segment over the length, L , of the beam will give the total work of deformation for the beam.

$$\Pi_i^{beam} = \int_{x=0}^{x=L} \frac{\Pi_i^s}{\Delta x} dx = \int_{x=0}^{x=L} \left(\frac{N^2}{EA} + \frac{\beta V^2}{GA} + M(x)u''(x) \right) \frac{1}{2} dx \quad (6.31)$$

If the influences from the normal- and shear forces are neglected the total work of deformation for the beam can be written as:

$$\Pi_i^{beam} = \frac{1}{2} \int_{x=0}^{x=L} M(x)u''(x) dx \quad (6.32)$$

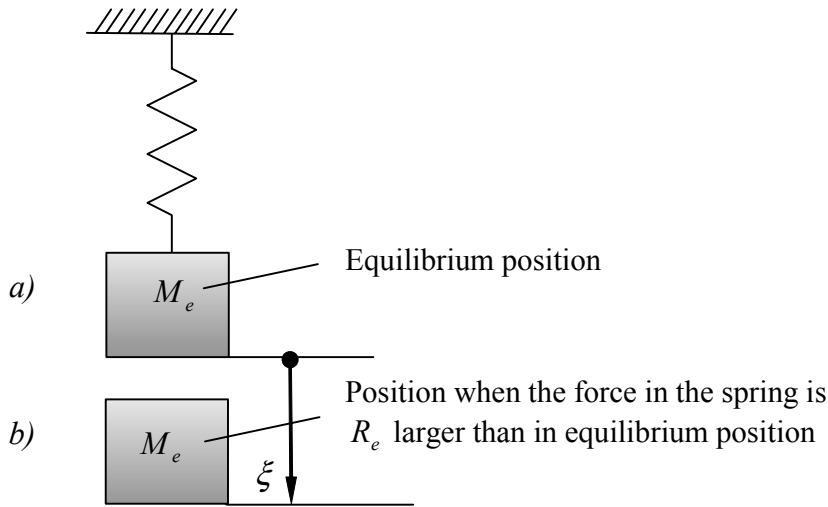

Figure 6.6 Mass in a) equilibrium position and b) moved ξ from equilibrium position.

Study the undamped SDOF system in Figure 6.6. The displacement ξ causes an internal work for the SDOF system which by use of Equation (6.23) can be written as:

$$\Pi_i^{SDOF} = \int_{\xi=0}^{\xi=u_s} R_e d\xi = \int_{\xi=0}^{\xi=u_s} K_e \xi d\xi = \frac{K_e u_s^2}{2} = \kappa_K \frac{K u_s^2}{2} \quad (6.33)$$

As stated in Section 6.2.3 the total internal work of the SDOF system shall be equal to the total work of deformation of the beam, meaning that Equation (6.32) shall be equal to Equation (6.33).

$$\kappa_K \frac{Ku_s^2}{2} = \frac{1}{2} \int_{x=0}^{x=L} M(x)u''(x)dx \quad (6.34)$$

The stiffness K of the beam is depending on the shape of the load and is determined by:

$$\int_{x=0}^{x=L} q(x,t)dx = Ku_s \quad (6.35)$$

The definition of stiffness K of the beam according to Equation (6.35) together with Equation (6.34) gives the final expression of the transformation factor for the internal force when having a linear elastic material.

$$\kappa_K = \frac{1}{Ku_s^2} \int_{x=0}^{x=L} M(x)u''(x)dx = \frac{1}{u_s} \frac{\int_{x=0}^{x=L} M(x)u''(x)dx}{\int_{x=0}^{x=L} q(x,t)dx} \quad (6.36)$$

For high beams it might be necessary to include the influences from the shear forces to get adequate results, see Section 6.2.4 for further discussion.

6.2.3.2 Ideal plastic material

As when deriving the work of deformation for the beam made of linear elastic material a lamella of the ideal plastic beam with length Δx is studied. For ideal plastic material the influence of the normal- and the shear force is neglected in the following derivation of the transformation factor. For high beams the influence of shear will cause the transformation factor to change noticeable.

Consider a situation when the moment, M , will increase to $M+dM$ and the deformation of the segment, Δm will increase to $\Delta m+d\Delta m$. The increase of the work of deformation is defined as the work achieved during the deformation $d\Delta m$.

$$d\Pi_i^s = Md\Delta m \quad (6.37)$$

where the moment M is constant within the segment.

In order to obtain the total work of deformation for the segment Equation (6.37) will be integrated over the deformation Δm .

$$\Pi_i^s = \int_0^{\Delta m} M d\Delta m = M \int_0^{\Delta m} d\Delta m = M\Delta m \quad (6.38)$$

Integration of the work of deformation for the segment over the length, L , of the beam will give the total work of deformation for the beam.

$$\Pi_i^{beam} = \int_{x=0}^{x=L} \frac{\Pi_i^s}{\Delta x} dx = \int_{x=0}^{x=L} M \frac{\Delta m}{\Delta x} dx = \int_{x=0}^{x=L} Mu''(x) dx \quad (6.39)$$

The internal work for the SDOF system, when the spring has ideal plastic behaviour, can be derived in the same way as for linear elastic behaviour (see Section 6.2.3.1). For an ideal plastic material the internal force is constantly equal to R_{me} if the displacement ξ exists (see Equation (6.24)).

$$\Pi_i^{SDOF} = \int_{\xi=0}^{\xi=u_s} R_e d\xi = R_{me} u_s = \kappa_K R_m u_s \quad (6.40)$$

As stated in Section 6.2.3 the total internal work of the SDOF system shall be equal to the total work of deformation of the beam, that is Equation (6.39) shall be equal to Equation (6.40).

$$\kappa_K R_m u_s = \int_{x=0}^{x=L} Mu''(x) dx \quad (6.41)$$

This gives the final expression of the transformation factor for the internal force when having an ideal plastic material.

$$\kappa_K = \frac{1}{R_m u_s} \int_{x=0}^{x=L} Mu''(x) dx \quad (6.42)$$

The maximum value of the internal force is equal to the external load (since the external load shall generate the same work of deformation as the internal resisting force).

$$R_m = \int_{x=0}^{x=L} q(x, t) dx \quad (6.43)$$

If Equation (6.43) is inserted in Equation (6.42) the transformation factor for the internal resisting force in case of ideal plastic behaviour is expressed as:

$$\kappa_K = \frac{1}{R_m u_s} \int_{x=0}^{x=L} Mu''(x) dx = \frac{1}{u_s} \frac{\int_{x=0}^{x=L} Mu''(x) dx}{\int_{x=0}^{x=L} q(x, t) dx} \quad (6.44)$$

6.2.3.3 Trilinear response material

The trilinear response curve in Figure 6.3.c can represent the response of a reinforced concrete beam subjected to pure bending, see Chapter 12 for the application on concrete material.

The derivation of the transformation factor for internal force and trilinear material is rather complex. Due to the difficulties to derive the expression of the transformation factor for a multilinear material it is here assumed to be convenient to use the transformation factor for linear elastic material in the analyses of trilinear material. The choice of transformation factor for the internal force for trilinear material is further discussed in Chapter 8.

6.2.4 Tabled transformation factors for beams

The values of the transformation factors for mass, load and internal force for the beams shown in Figure 6.7 are calculated in Appendix A to B and are shown in Table 6.1. The system point is placed in the middle of the beam for all cases except of cantilever beams, when it is placed in the free end of the beam. When having linear elastic material the natural shape of deformation, meaning the shape of deformation according to theory of elasticity for a beam subjected to a static load, is assumed. In case of ideal plastic material the mechanisms according to theory of plastic hinges is assumed (see examples in Appendix B).

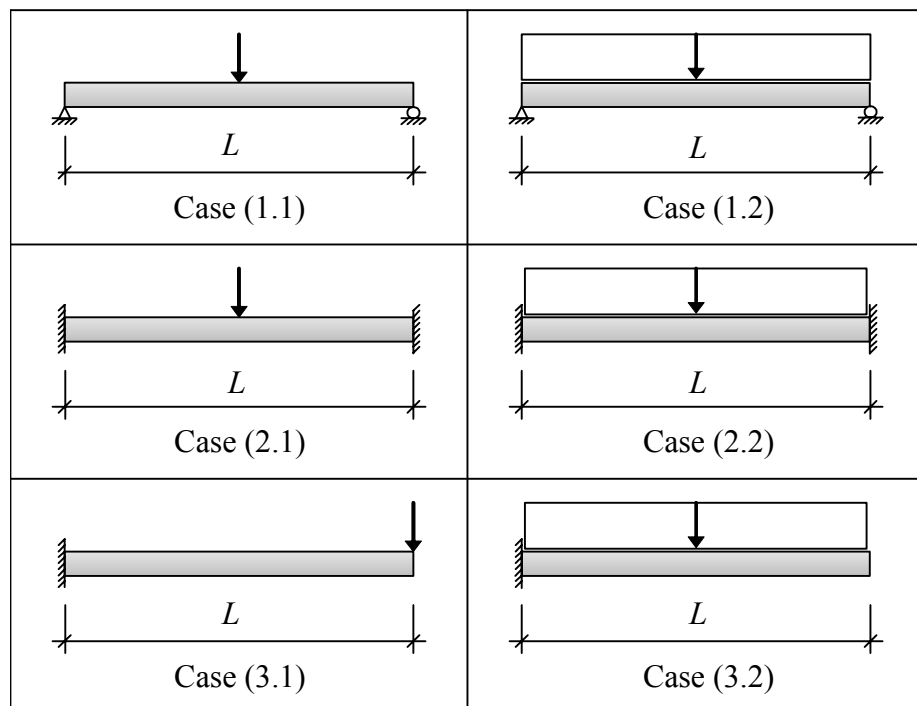

Figure 6.7 The six different cases.

Table 6.1 Transformation factors for beams shown in Figure 6.7

	Material	κ_P	κ_M	κ_K	κ_{MP}	κ_{KP}
Case (1.1)	Elastic	1.0	0.486	1.0	0.486	1.0
	Plastic	1.0	1/3	1.0	1/3	1.0
Case (1.2)	Elastic	0.640	0.504	0.640	0.787	1.0
	Plastic	0.5	1/3	0.5	2/3	1.0
Case (2.1)	Elastic	1.0	0.371	1.0	0.371	1.0
	Plastic	1.0	1/3	1.0	1/3	1.0
Case (2.2)	Elastic	0.533	0.406	0.533	0.762	1.0
	Plastic	0.5	1/3	0.5	2/3	1.0
Case (3.1)	Elastic	1.0	0.236	1.0	0.236	1.0
	Plastic	1.0	1/3	1.0	1/3	1.0
Case (3.2)	Elastic	0.400	0.257	0.400	0.642	1.0
	Plastic	0.5	1/3	0.5	2/3	1.0

Granström (1958) and Balasz (1997) have used a different expression for the transformation factor for the internal force, the relation with the transformation factor used here are shown in Appendix C.

When taking the influences from shear into account the transformation factor depends also on the shear modulus and consequently the Poisson's ratio ν . In case of a fixed concrete beam ($\nu \approx 0.15$) with linear elastic material, subjected to a uniformly distributed load and the length of the beam is ten times the height ($L=10h$) the contribution from the shear to the transformation factor for internal force is 0.01 according to Wendt (2006). In Table 6.1 it is seen that in this case, when the influence of shear is not taken to account, the transformation factor for the internal force is 0.533. The transformation factor for the internal force is thus $0.533+0.01=0.543$ when influences from shear are included. When the length of the beam is five times the height ($L=5h$) the contribution from the shear to the transformation factor for internal force is 0.06 according to Wendt (2006) and the value of the transformation factor for internal force is $0.533+0.06=0.593$ when influences of shear are taken into account.

7 Comparison of SDOF and FE analyses for beams

In order to verify the results of the analysis where the beam is represented by an SDOF system, a comparison to the results in a finite element analysis (FE analysis) is made. The FE analysis is here assumed to give results accurate enough to be equal to the real behaviour of the beam.

Due to limitations in the SDOF analysis the influences of higher order modes are not taken into account while it is in the FE analysis. When analysing a beam with trilinear material response a difference between the SDOF and FE results is expected since the transformation factors for linear elastic material is used in this case as discussed in Section 4.2.3.

7.1 Typical examples

Comparisons are made for four different cases; simply supported beam subjected to concentrated and uniformly distributed load respectively, and beam with fixed ends subjected to concentrated and uniformly distributed load respectively. The different cases are shown in Figure 7.1.

Each case will be analysed for linear elastic (1 analysis), ideal plastic (1 analysis) and trilinear material (3 analyses) as described in Chapter 6. Further each case with each material model will be analysed as a SDOF system as well as a MDOF system. This summons up in $4 \cdot (1 + 1 + 3) \cdot 2 = 40$ analyses. The MDOF system is analysed by use of the commercial code ADINA (2004).

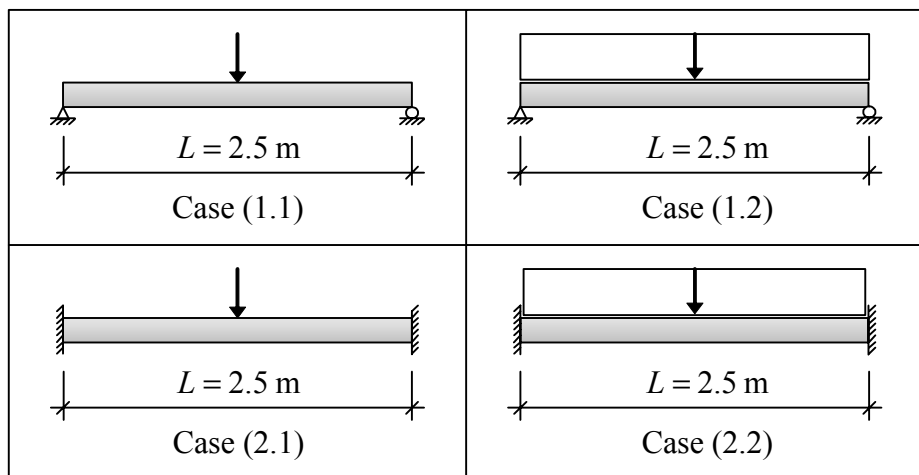

Figure 7.1 The four different cases.

The choice of material properties and geometry of the beam is based on the requirements in the Swedish shelter regulations, Räddningsverket (2003), also

discussed in Section 12.3. The geometry of the beam will be the same for all cases with a length of 2.5 meters and a cross-section as shown in Figure 7.2.

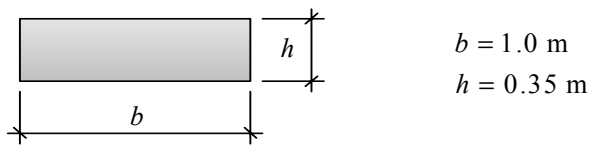

Figure 7.2 The cross-section of the beams used in the typical examples.

It is necessary to use material properties and loads that agree in both FE and SDOF analyses in order to facilitate the comparison of the results from the different analyses.

The load applied is triangular in time, as shown in Figure 7.3. Where the total time for the load is 1.0 ms and the maximum value of the load (P_1), also called the peak value of the load, is chosen to occur when 10% of the total time for the load has elapsed. In reality the peak load occurs at time 0.0 ms but since this can cause numerical problems the approximation described above is used.

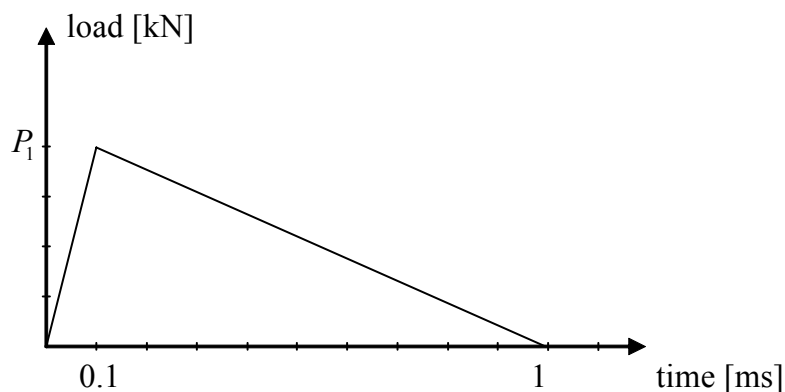

Figure 7.3 Time function of the load.

The peak value of the load differs in the analyses. When having a trilinear material three different analyses are made for each typical example. One for a load small enough to stay in the elastic range, one for a load large enough to leave the elastic range but still small enough not to reach the plastic range and one with a load large enough to reach the plastic range, see Figure 7.4.

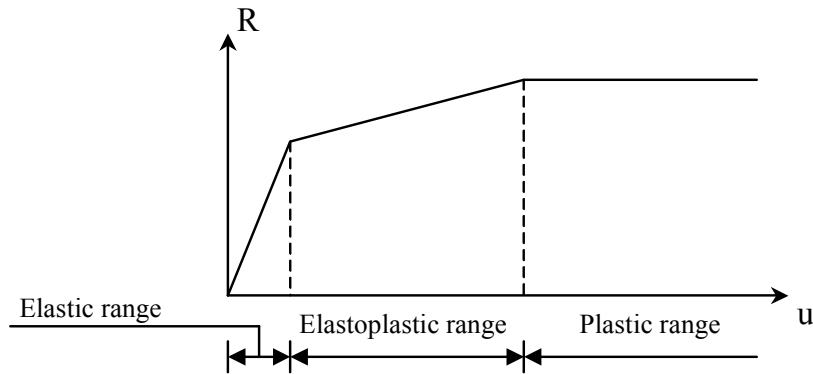

Figure 7.4 The different ranges for a trilinear material.

In case of trilinear material the maximum load value when elastic behaviour is wanted is chose to be $P_I=0.8P_{cr}$, when elastoplastic behaviour is wanted $P_I=0.8(R_m-P_{cr})$ and for plastic behaviour $P_I=2R_m$. Table 7.1 shows the values of the peak load for the different analyses. In case of uniformly distributed load the peak value of the load is $q_I=P_I/L$.

Table 7.1 Peak values for the loads applied to the beams.

Material		Case (1.1)	Case(1.2)	Case (2.1)	Case (2.2)
		Peak load, P_I [kN]	Peak load, P_I [kN]	Peak load, P_I [kN]	Peak load, P_I [kN]
Linear elastic		132	268	120	184
Ideal plastic		4810	9640	4220	8560
Trilinear	Elastic range	132	268	120	184
	Elastoplastic range	1954	3920	1715	3467
	Plastic range	4810	9640	4220	8560

In the SDOF analyses the total time for the analysis is set to 30 ms and 10000 time steps are used which gives a constant time increment, Δt , equal to 0.003 ms. This time step is also used in case of elastic material in the FE analyses. In case of ideal plastic and trilinear material the time step is decreased since otherwise convergence problems will occur in ADINA (2004), see Section 7.1.2. In these analyses a time step increment of 0.0015 ms are used. The time increment of 0.003 ms in the SDOF analyses for ideal plastic and trilinear material remains.

When analysing a beam as a SDOF system with trilinear behaviour (for example a reinforced concrete beam) the material properties are often given as the relation between load and displacement while in the FE analyses the stress-strain relation is required. How to obtain an approximate stress-strain relation from the load-displacement curve for the beams in the typical examples are shown in Appendix D. The corresponding notations when using a stress-strain relation and a load-displacement relation are shown in Figure 7.5.

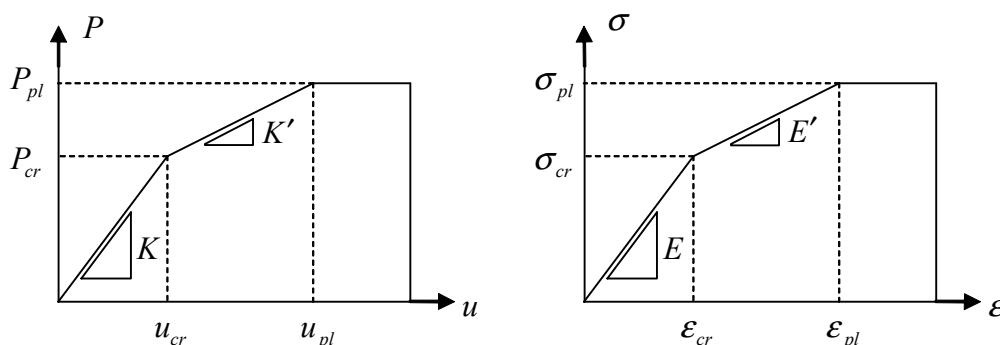

Figure 7.5 Notations for material properties for load-displacement relation and stress-strain relation respectively.

It shall be observed that the modelled beams in ADINA (2004) will not vibrate as a reinforced concrete beam since plastic deformations occur also in the elastoplastic range while a reinforced concrete beam have elastic behaviour in both elastic and elastoplastic range, see Section 3.1.3. The solution of the SDOF analyses are here forced to have the same behaviour meaning that plastic deformations will occur as fast as the elastoplastic range is entered. However, this will not influence the value of the maximum deflection and are therefore application able on analyses of reinforced concrete beams as long as the maximum value of the displacement is to be found.

7.1.1 SDOF analysis

Analyses of the SDOF system are made in OCTAVE using MATLAB programming language, developed for this project that computes the displacement for each time step for the three different types of material responses. The computations are made by using the explicit central differential method, see Section 5.2. The material data needed to perform the calculations for the different materials are calculated in Appendix D and shown in Table 7.2 where the meaning of the notations can be seen in Figure 7.5.

Table 7.2 Material properties for SDOF analysis.

Material		P_{cr} [kN]	P_{pl} [kN]	K'/K	σ_{pl} [MPa]	E [GPa]
Linear elastic		-	-	-	-	38.6
Ideal plastic		-	-	-	4.45	-
Trilinear	Case (1.1)	53.8	218.2	0.0774	-	38.6
	Case (1.2)	107.7	436.4			
	Case (2.1)	107.7	436.4			
	Case (2.2)	161.5	872.9			

7.1.2 FE model

The program used for the FE analyses is the commercial code ADINA (2004) where the solution method is Newmark with $\delta=0.5$ and $\alpha=0.25$. This method is also called the trapezoid method or constant-average-acceleration method, see Section 5.1.

Different FE models are used for the different material responses. Due to limitations in the ADINA (2004) program the elements used to model the beam will not be the same for all cases. In the cases of elastic and ideal plastic material the beam is modelled with 2-node beam elements as shown in Figure 7.6. When having elastic material the beam is divided into twenty equally sized elements (see Appendix E).

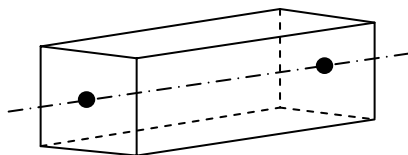

Figure 7.6 Beam element with constant, rectangular cross-section.

In case of an ideal plastic material the beam is divided into parts modelled with ideal plastic material and parts with linear elastic material in order to imitate the assumed mechanisms. The elements with ideal plastic material are located where the assumed plastic hinges are located, see Figure 3.13. The linear elastic part of the beam is divided into 48 elements and the total number of ideal plastic elements differs due to the different numbers of plastic hinges for different beams. In case of simply supported beams the total length of the part modelled with linear elastic material is 2.45 m and in case of a beam fixed in both ends the total length of the elastic part is 2.4 m. For all beams the length of the ideal plastic elements are 2.5 cm. Constraints are used in the nodes belonging to the elastic part of the beam in order to have no curvature. The rotation of these nodes is constrained to be the same as in the node in between the element with plastic material in the middle, in case of simply supported

beam, and at the supports, in case of fixed beam, and the last elastic element. This is done in order to imitate the assumed mechanisms even more. The beams in the ideal plastic analyses are shown in Figure 7.7 and Figure 7.8.

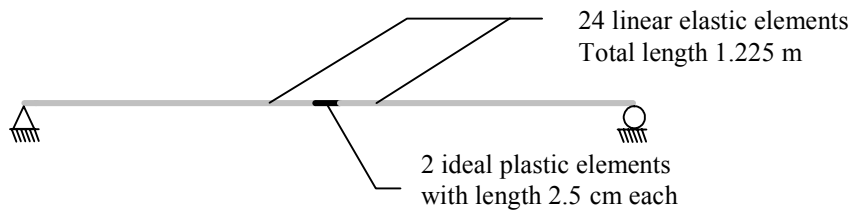

Figure 7.7 Modelled beam (simply supported) for ideal plastic material.

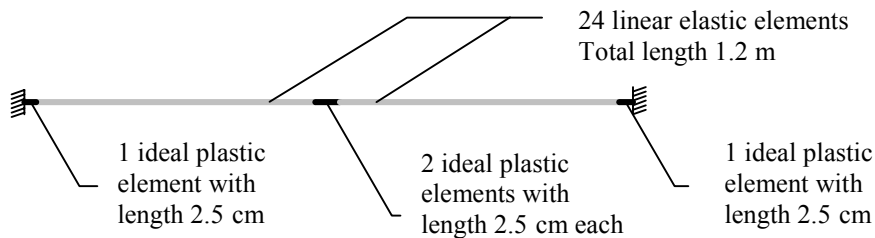

Figure 7.8 Modelled beam (fixed in both ends) for ideal plastic material.

When having a trilinear material (modelled with multilinear material) the beam cannot be modelled with beam elements in ADINA (2004). Instead 2-node isobeam elements are used. The beam is divided in three hundred parts in the longitudinal direction in case of uniformly distributed loads. In case of concentrated loads an odd number of elements will be used in order to avoid an unrealistic deformation in the midzone. 299 elements are used in these cases (see Appendix E) and the middle element has trilinear material behaviour while the other elements will have a material response as shown in Figure 7.9, here called bilinear material behaviour, in order to avoid large plastic deformations here. The length of the midpoint element is 2.5 cm, see Figure 7.10 and Figure 7.11.

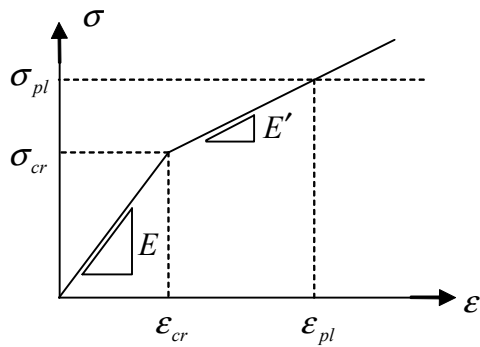

Figure 7.9 Bilinear material behaviour used in all elements except the midpoint element in case of trilinear material and concentrated load.

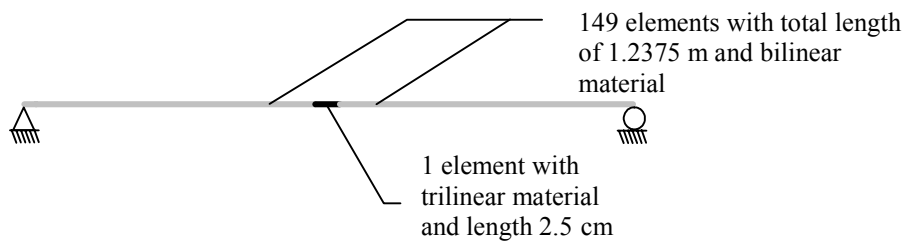

Figure 7.10 Modelled beam (simply supported) for trilinear material in case of concentrated load.

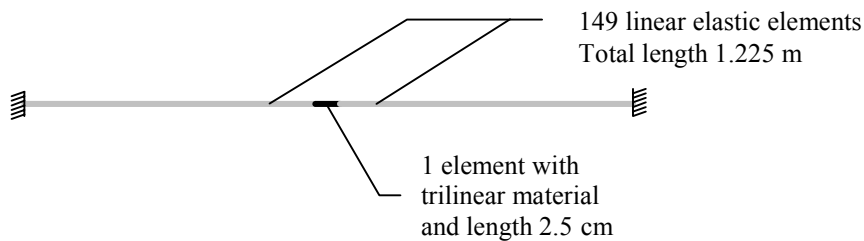

Figure 7.11 Modelled beam (fixed in both ends) for trilinear material in case of concentrated load.

The main difference between beam and isobeam elements is that beam elements have 2 nodes while isobeam elements can have 2, 3 or 4 nodes where 3- and 4-node isobeam elements can be used to define curved beams (see Figure 7.12). Even though there are some calculation differences when using 2-noded isobeam elements instead of beam elements the results will be very similar. For further information see ADINA (2004). The material data used to perform the calculations for the different materials are shown in Table 7.3.

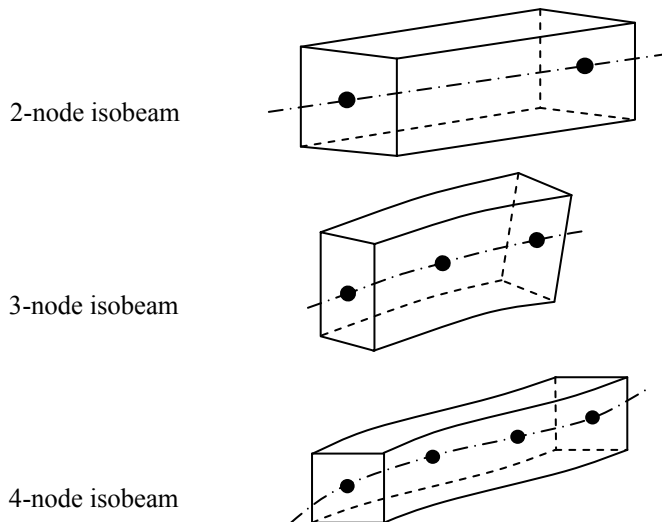

Figure 7.12 General 3-D isobeam elements. From ADINA (2004).

Table 7.3 Material properties for FE analysis

Material	E [GPa]	E' [GPa]	σ_{cr} [MPa]	σ_{pl} [MPa]	ϵ_{cr} [‰]	ϵ_{pl} [‰]
Linear elastic	38.6	-	-	-	-	-
Ideal plastic	5000 ¹⁾	-	-	4.45 ²⁾	-	-
Trilinear	38.6	2.99	1.65	4.45	0.043	0.98

1) In ADINA (2004) it is not possible to model an ideal plastic material but in order to imitate this behaviour a bilinear plastic material is used where the modulus of elasticity in the elastic part is chosen to be large enough to get accurate result. By testing it was found that a suitable value of the modulus of elasticity was 5000 GPa see Appendix E.

2) The elements in the beam that are not connected to any assumed plastic hinge are modelled with linear elastic material in order to avoid yielding in these elements.

7.2 Results

7.2.1 Linear elastic material

In the SDOF- and FE analyses with linear elastic material the input shown in Table 7.2 and Table 7.3 were used. The displacement-time relations from SDOF and FE analyses for linear elastic material are compared in Figure 7.13.

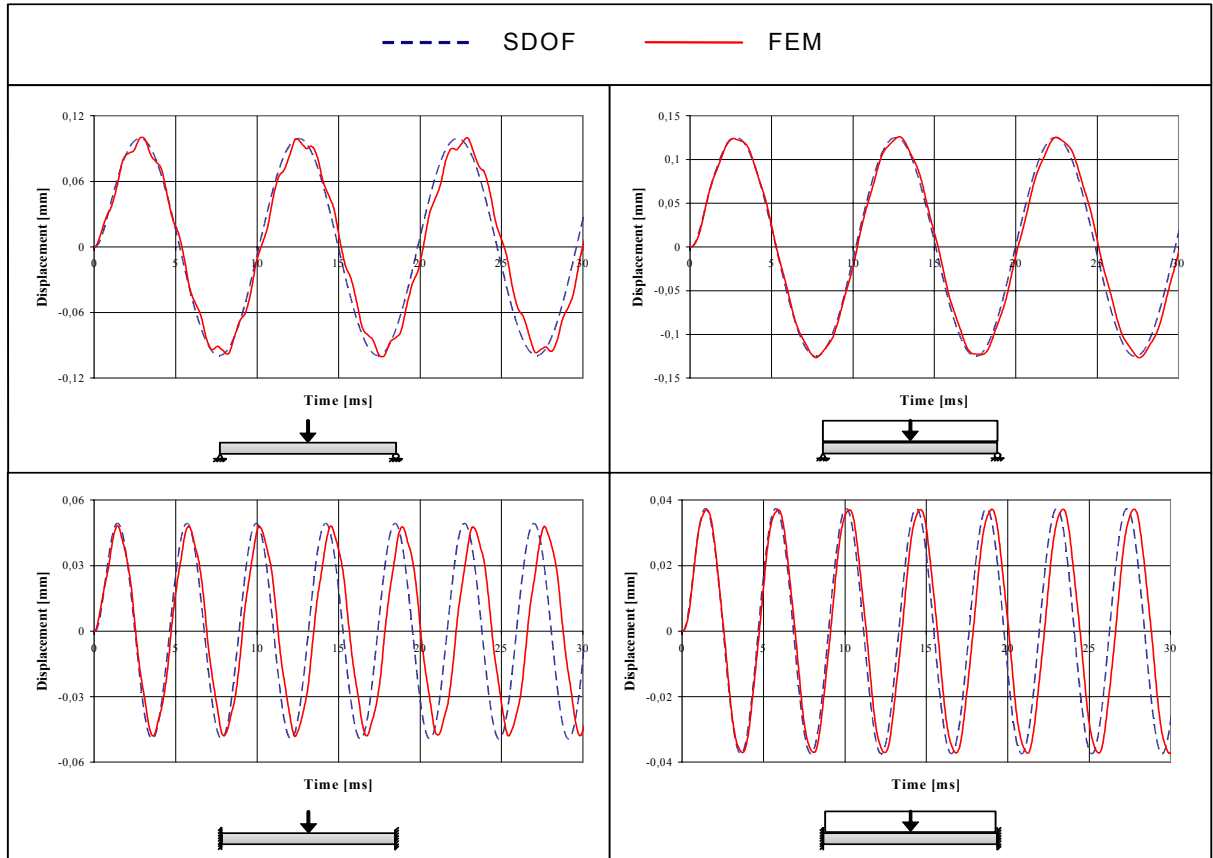

Figure 7.13 Displacement-time relations from analyses for linear elastic material.

As predicted there are influences from higher modes in the results from the FE analyses. These are represented by a non smooth character of the curve. When comparing the FE results for the different cases it can be observed that the higher modes influence the beams subjected to a concentrated load more than they affect the results for a beam subjected to a uniformly distributed load.

There is a good agreement between the curves representing the SDOF and FE solution.

A phase shift between the results from the SDOF and FE analysis can be noticed in case of concentrated load.

7.2.2 Ideal plastic material

In the SDOF- and FE analyses with ideal plastic material the input shown in Table 7.2 and Table 7.3 were used. The displacement-time relations from SDOF and FE analyses for ideal plastic material are shown in Figure 7.14.

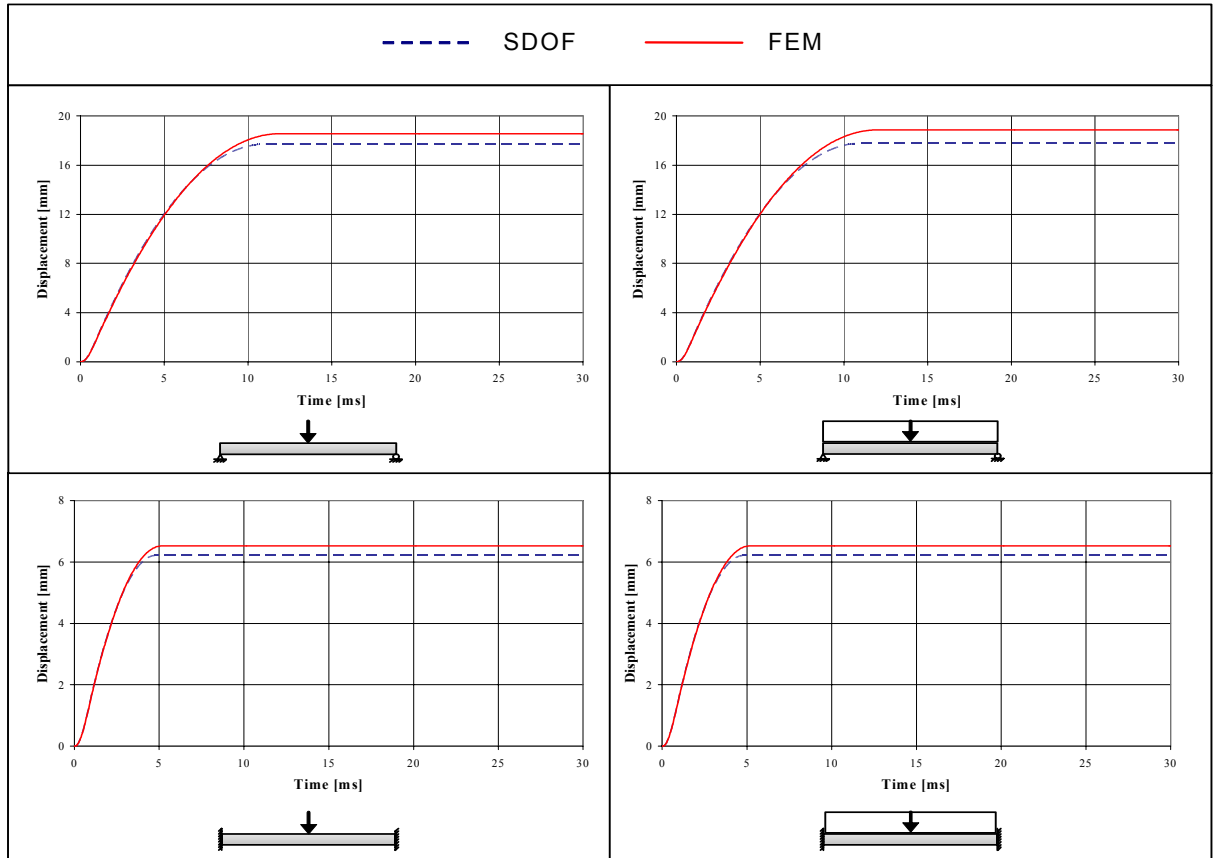

Figure 7.14 Displacement-time relations from analyses for ideal plastic material.

The values of the maximum displacement from the SDOF analysis are lower than the values from the FE analyses but the difference is rather small for all cases and the SDOF results are acceptable approximations of the FE results. The lower value can be explained by the fact that the same behaviour are not exactly the same in SDOF and FEM.

7.2.3 Trilinear material

The results from the analyses when having a trilinear material are presented in this section. Due to the change in behaviour for different loads three different values of loads are used for each case see Table 7.1. In the SDOF- and FE analyses with trilinear material the input shown in Table 7.2 and Table 7.3 are used.

7.2.3.1 Elastic range

For a load small enough all points in the beam will remain elastic meaning that the beam will vibrate about the position of the unloaded beam. Since the only differences between these analyses and the analyses for linear elastic material is that the beam is modelled with isobeam elements instead of beam elements and that more elements are

used (300 or 299 instead of 20) the results will be identical or nearly identical in those cases see Section 7.2.1. The displacement-time relations from SDOF and FE analyses for trilinear material, elastic range, are shown in Figure 7.15.

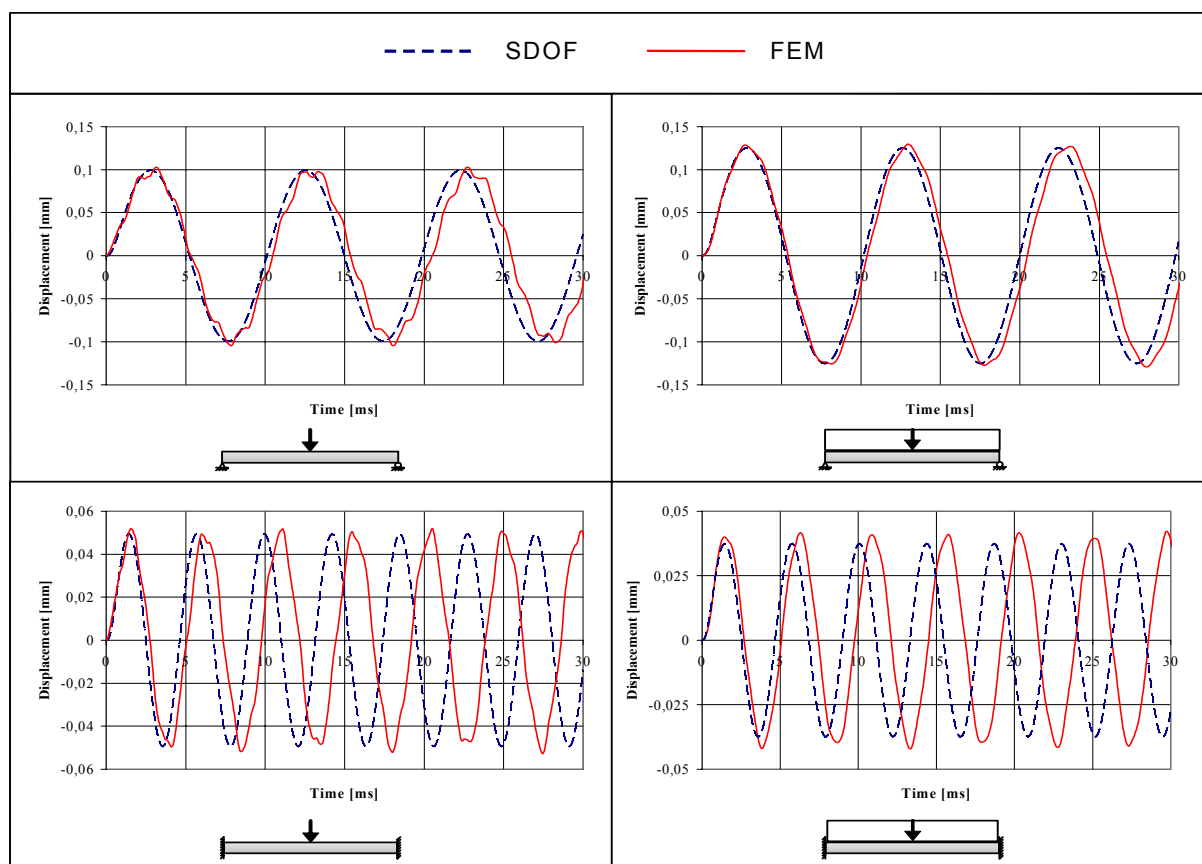

Figure 7.15 Displacement-time relations from analyses for trilinear material, elastic range.

The results are very similar to the results achieved in the analysis of linear elastic material, see Section 7.2.1, but one difference worth attention is that the phase shifts have increased for all cases. One difference between the two analyses that could be the reason for this difference is that for the trilinear material isobeam elements are used while beam elements are used for the linear elastic material. Also the element mesh differs in the two analyses. In case of linear elastic material 20 elements are used while 300 or 299 are used in case of trilinear material. With these exceptions the comments are the same as for the results achieved in the analyses of linear elastic material.

7.2.3.2 Elastoplastic range

For a load large enough to leave the linear elastic range but still small enough not to reach the plastic range there will be plastic deformations of the beam leading to oscillations about a value not identical to the unloaded position. The displacement-time relations from SDOF and FE analyses for trilinear material, elastoplastic range, are shown in Figure 7.16.

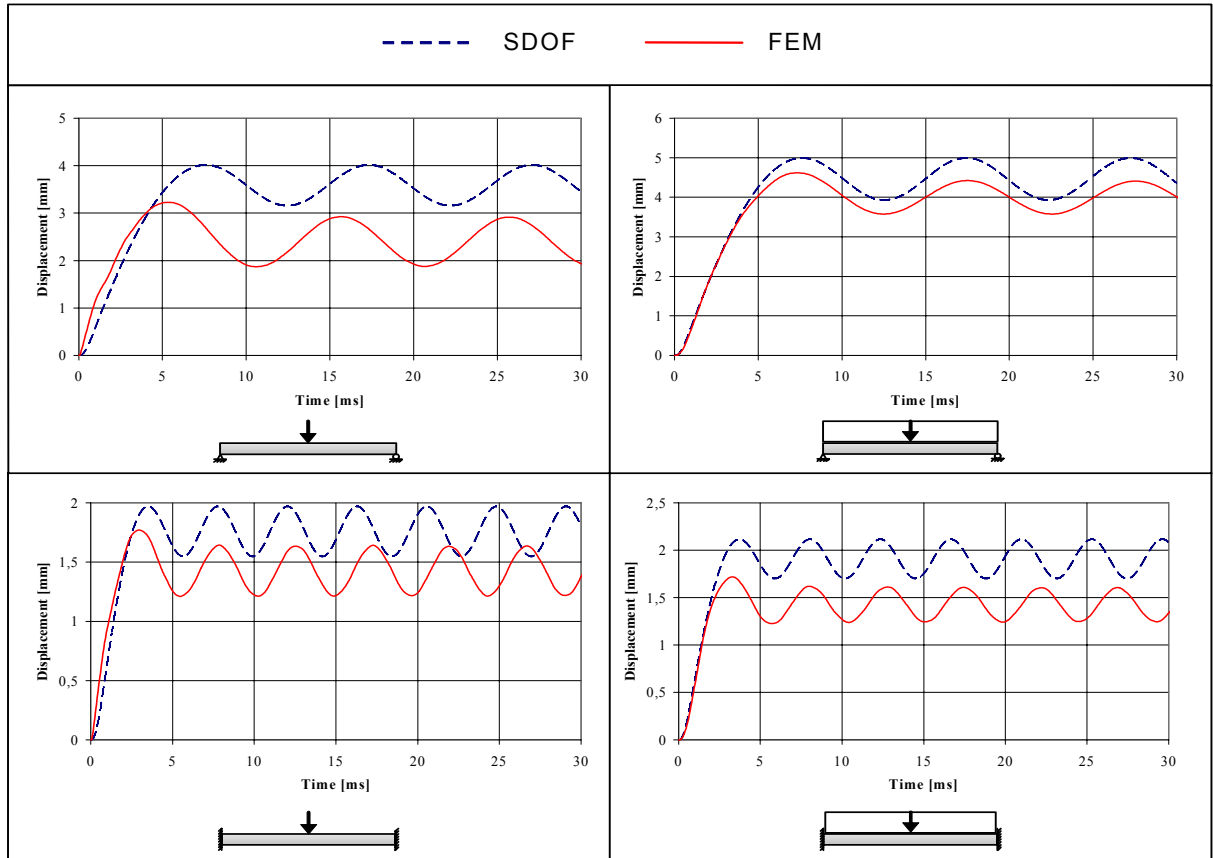

Figure 7.16 Displacement-time relations from analyses for trilinear material, elastoplastic range.

The SDOF analyses overestimate the maximum displacement of the system point for all cases. A reason for the differences in value of the maximum displacement, comparing the SDOF with the FE solution, is that the transformation factor for the linear elastic material is used through the whole analyses instead of using transformation factors especially derived for this kind of material, see Section 6.2.3.3. Another reason, probably the most important, is that the relation between the load and displacement is not exactly the same for the SDOF and FE analyses see Appendix D.

In the FE analyses there is a difference between the maximum displacements in the first oscillation compared to the maximum displacements in the following oscillations. This loss in maximal displacement is not represented in the SDOF analysis where all the oscillations have the same maximal displacement.

7.2.3.3 Plastic range

For a load large enough to reach the plastic range there will be plastic deformations in the beam, causing the beam to oscillate around a value not identical to the unloaded position. The displacement-time relations from SDOF and FE analyses for trilinear material, plastic range, are shown in Figure 7.17.

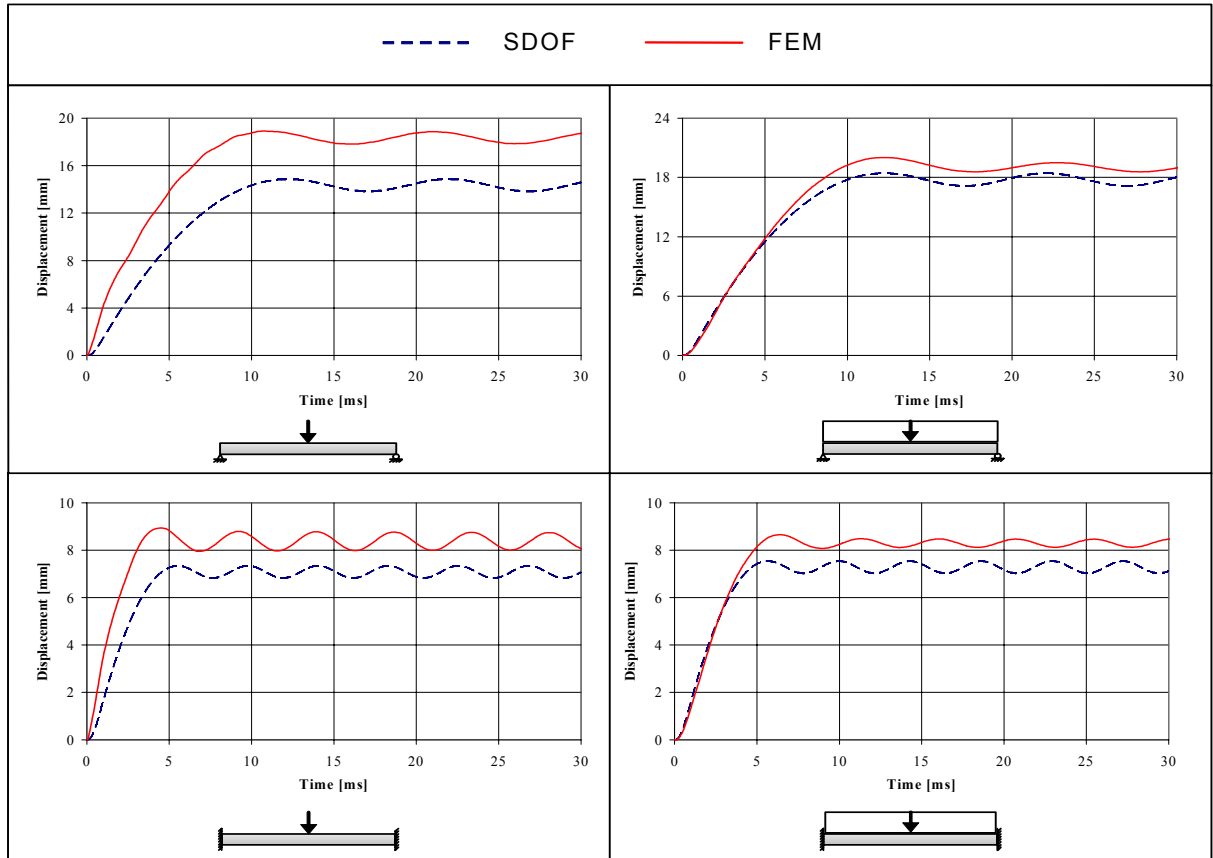

Figure 7.17 Displacement-time relations from analyses for trilinear material, plastic range.

As seen in Figure 7.17 the difference between the SDOF and FE analyses is rather large for beams subjected to concentrated loads. Even though the FE models of the beam in case (1.1) and (2.1) are made in order to avoid large and unrealistic midpoint displacements in the very beginning of the analyses the fast load application probably influences the FE results more than the SDOF results. In Figure 7.18 where the standardized deflection along the beam from the FE analysis in case (1.1) and (2.1) are shown together with the assumed shape of deformation in the SDOF analysis. The two shapes of deformation (meaning SDOF and FE) are not the same which partly explains the difference between results from the SDOF and FE analyses in case of concentrated loads.

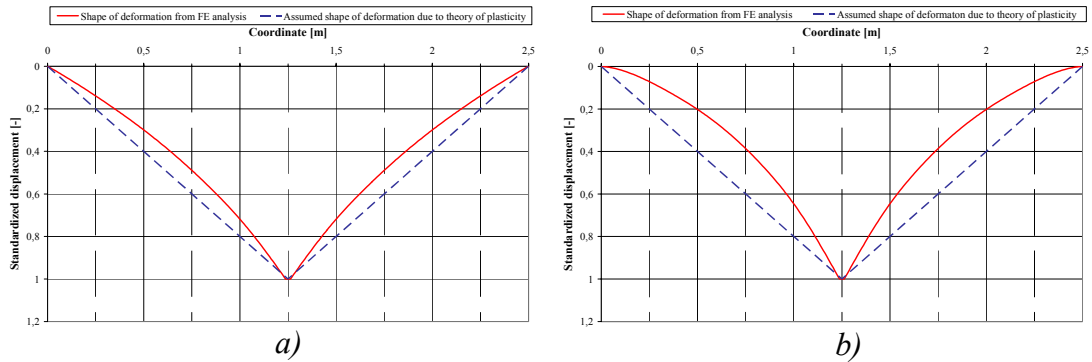

Figure 7.18 Standardized displacement along the beam in a) case (1.1) and b) case (2.1) compared to the assumed shape of displacement in the SDOF analyses.

The standardized shapes of deflection for case (1.2) and (2.2) are shown in Appendix F.

In case of uniformly distributed loads the results agree more even though unrealistic deflections appear at the supports in case (2.2). This behaviour can be explained by the fact that the information is spread with delay inside the beam meaning that in the very beginning of the loading the zones at the supports reaches high stresses before the information has been transported to the rest of the beam (further discussed in Section 12.1). This phenomenon is not taken into account in the SDOF analyses. A more realistic value of the midpoint deformation can be estimated as shown below.

The deformation along the beam in case (2.2) is shown in Figure 7.19 where an unrealistic deformation occurring at the supports can be seen. These appear in the very beginning of the analysis and affects values of the midpoint deflection. A more realistic value of the displacements at the supports from the FE analysis is shown in Figure 7.20. In Figure 7.21 the more realistic midpoint displacement is shown together with the SDOF result and the unrealistic FE result.

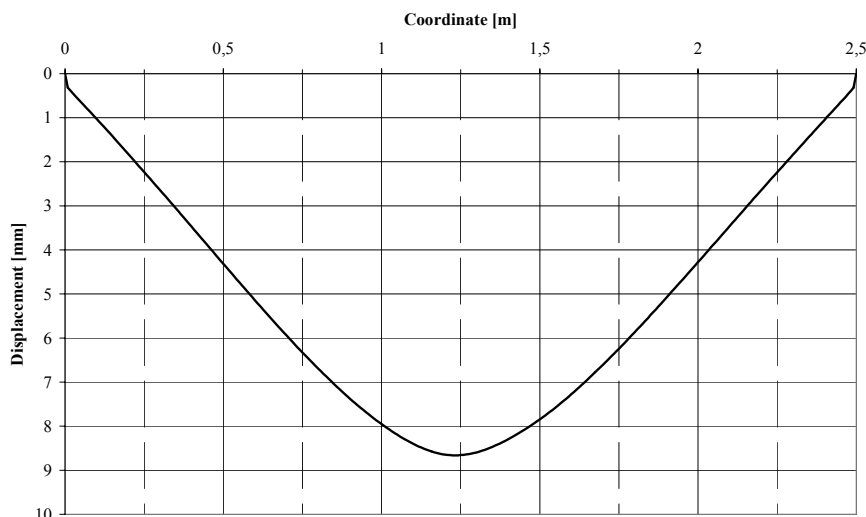

Figure 7.19 Displacement along the beam in case (2.2).

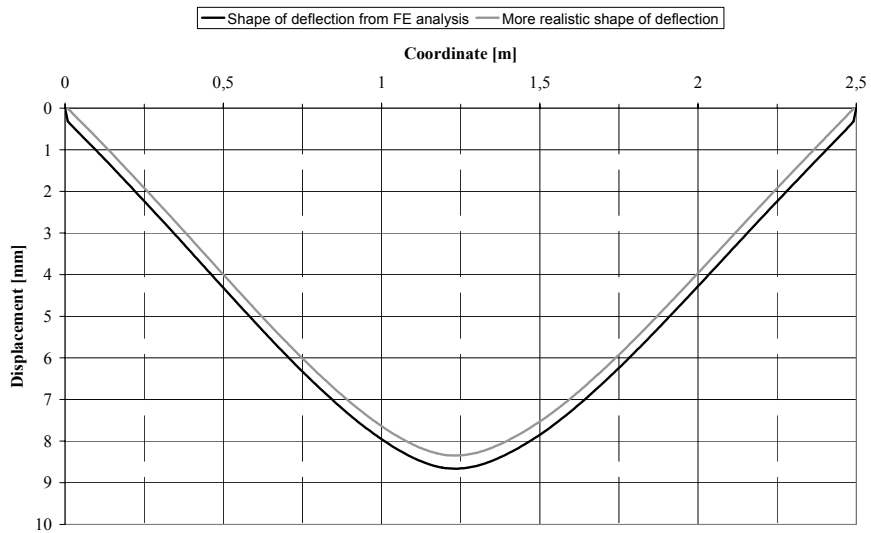

Figure 7.20 Estimated displacement for the beam in case (2.2)

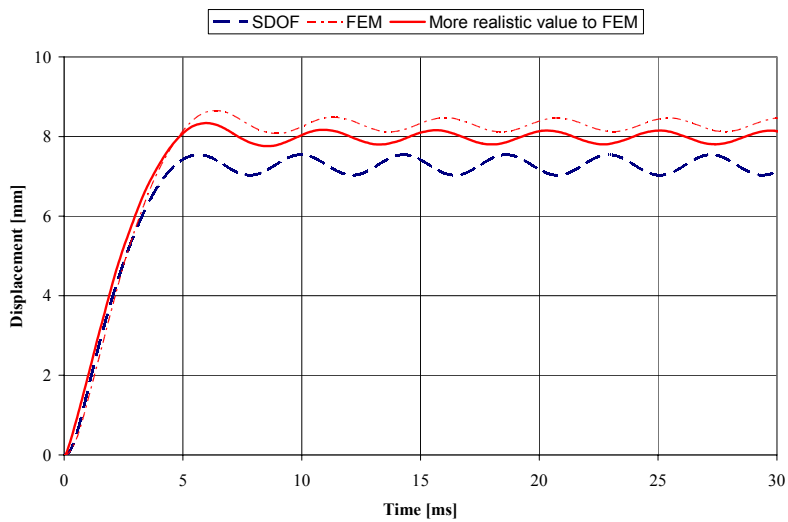

Figure 7.21 More realistic displacement for the beam in case (2.2) compared to the SDOF result.

8 Comments to and discussion about Chapter 7

8.1 Transformation factors for trilinear material

In the analyses made in Chapter 7 the linear elastic transformation factors are used when analysing SDOF systems with trilinear material since the derivation of the transformation factor for internal force and trilinear material is rather complex. The choice of transformation factors in case of trilinear material is discussed here.

Different approximations and simplifications can be used in order to facilitate dynamic analyses of trilinear materials. Two approximation methods, convenient to use in many cases according to Norris (1959), is discussed here.

8.1.1 Sudden change of transformation factors

Norris (1959) declares that, even though a sudden change of transformation factors is unrealistic when analysing an elastoplastic material, it is often assumed to be convenient to use this approximation for purposes of analysis. This means that it is assumed to be convenient to use the transformation factor for linear elastic material in the elastic range and the transformation factor for plastic case in the plastic range. When this statement is applied on trilinear material also the elastoplastic range has to be considered.

In the elastoplastic range the transformation factor can be derived in the same way as in the case of linear elastic and ideal plastic material. However, this is not done here since the expression will depend on the value of the internal force where there is a drastic change of material behaviour. In order to avoid these complex expressions it is assumed to be suitable to use transformation factor for linear elastic materials in the elastic range, an average value of the elastic and plastic transformation factor in the elastoplastic range and transformation factor for ideal plastic materials in plastic range.

$$\kappa^{elpl} = \frac{\kappa^{el} + \kappa^{pl}}{2} \quad (8.1)$$

where κ^{elpl} , κ^{el} and κ^{pl} are the transformation factors in the elastoplastic, elastic and plastic range respectively.

In case of trilinear material the differential equation in the different ranges is:

$$\begin{aligned} &\text{In the elastic range} \\ &M_e \ddot{u} + K_e u = P_e \end{aligned} \quad (8.2)$$

$$\begin{aligned} &\text{In the elastoplastic range} \\ &M_e \ddot{u} + K_e u_{cr} + K'_e (u - u_{cr}) = P_e \end{aligned} \quad (8.3)$$

In the plastic range

$$M_e \ddot{u} + R_{me} = P_e \quad (8.4)$$

By use of transformation factors Equations (8.2) to (8.4) can be written as:

In the elastic range

$$\kappa_M^{el} M \ddot{u} + \kappa_K^{el} K u = \kappa_P^{el} P \quad (8.5)$$

In the elastoplastic range

$$\kappa_M^{elpl} M \ddot{u} + \kappa_K^{elpl} (K u_{cr} + K'(u - u_{cr})) = \kappa_P^{elpl} P \quad (8.6)$$

In the plastic range

$$\kappa_M^{pl} M \ddot{u} + \kappa_K^{pl} R_m = \kappa_P^{pl} P \quad (8.7)$$

or

In the elastic range

$$\kappa_{MP}^{el} M \ddot{u} + \kappa_{KP}^{el} K u = P \quad (8.8)$$

In the elastoplastic range

$$\kappa_{MP}^{elpl} M \ddot{u} + \kappa_{KP}^{elpl} (K u_{cr} + K'(u - u_{cr})) = P \quad (8.9)$$

In the plastic range

$$\kappa_{MP}^{pl} M \ddot{u} + \kappa_{KP}^{pl} R_m = P \quad (8.10)$$

In case of a fixed beam subjected to a uniformly distributed load the transformation factors in Equations (8.8) and (8.10), shown in Table 6.1 ,are:

$$\begin{aligned} \kappa_{MP}^{el} &= 0.762 \\ \kappa_{KP}^{el} &= 1.0 \\ \kappa_{MP}^{pl} &= 2/3 \\ \kappa_{KP}^{pl} &= 1.0 \end{aligned} \quad (8.11)$$

and the transformation factors in the elastoplastic range, calculated by means of Equation (8.1) are:

$$\begin{aligned} \kappa_{MP}^{elpl} &= \frac{0.762 + 0.667}{2} = 0.714 \\ \kappa_{KP}^{elpl} &= 1.0 \end{aligned} \quad (8.12)$$

The transformation factor κ_{KP} equals 1.0 in all ranges why only the value of the equivalent mass will change. Since the value of κ_{MP} decreases when a new range is entered it can be compared with taking away or losing mass. This means that when using this method, where a sudden change of the transformation factors is allowed, the energy will be drastically decreased when a new range is entered. This is graphically

shown in Figure 8.1 where the energy of the SDOF system is studied when analysing the beam in Section 12.4. The total energy used by the SDOF system will be lower than the total energy applied to the system which is not realistic and will result in underestimated value of the final displacement.

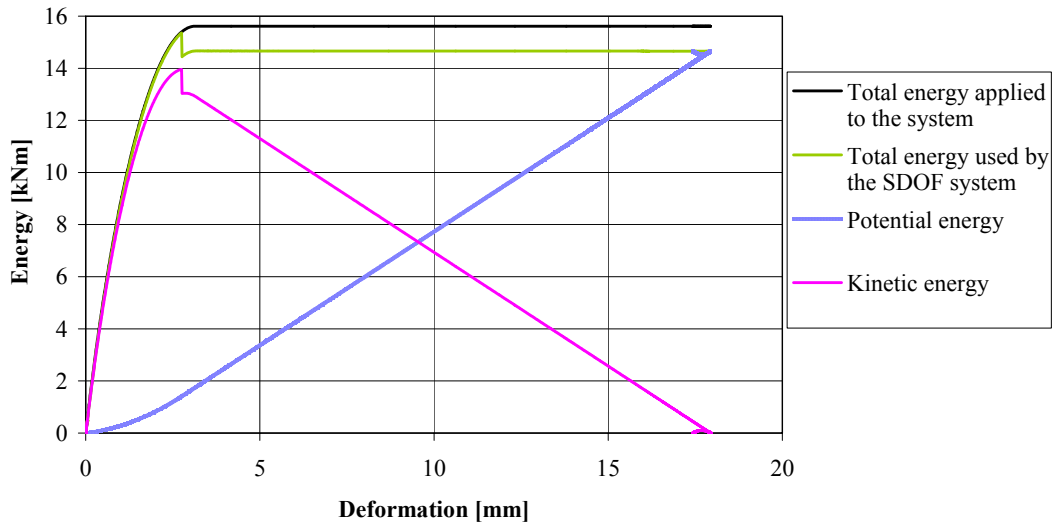

Figure 8.1 Energy, applied and internal, for SDOF system analysed by use of different transformation factors in different ranges.

This is easily seen by studying areas representing the total internal energy when the maximum displacement is reached, see Figure 8.2. When the maximum displacement is reached the total internal energy equals the maximum potential energy $R \cdot u_{max}$. Since the internal resisting force is equal in the two cases, if it is assumed that the ideal plastic range is reached, the maximum displacement in $u_{max,2}$ case 2 must be larger than the maximum displacement $u_{max,1}$ in case 1.

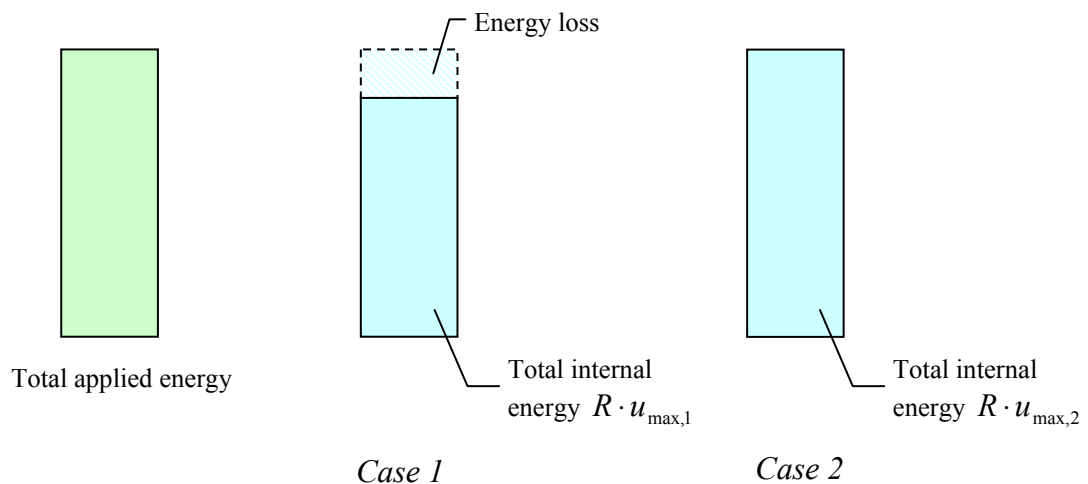

Figure 8.2 Total internal energy in case 1, where energy is lost due to change of transformation factors, and case 2 where no energy is lost.

In order to compensate the loss of mass, and hence energy, when entering a new range the value of the acceleration can be increased in this point. This is here only shown

when going from the elastic range to the elastoplastic range but the same method is used when going from the elastoplastic to the plastic range.

Just before the elastoplastic range is entered the displacement is u_{cr}^- and the differential equation is:

$$\kappa_{MP}^{el} M \ddot{u}_{cr}^- + \kappa_{KP}^{el} K u_{cr}^- = P \quad (8.13)$$

The displacement when the elastoplastic range is entered is u_{cr} and the differential equation is:

$$\kappa_{MP}^{elpl} M \ddot{u}_{cr} + \kappa_{KP}^{elpl} K u_{cr} = P \quad (8.14)$$

The transformation factor κ_{KP} is equal to 1.0 and in order to keep the energy constant in this specific point Equation (8.15) must be fulfilled.

$$\kappa_{MP}^{elpl} M \ddot{u}_{cr} = \kappa_{MP}^{el} M \ddot{u}_{cr}^- \quad (8.15)$$

giving:

$$\ddot{u}_{cr} = \frac{\kappa_{MP}^{el}}{\kappa_{MP}^{elpl}} \ddot{u}_{cr}^- \quad (8.16)$$

However, this is not done in the analyses discussed in this report. Instead constant values of the transformation factors are used trough the analyses giving no energy loss.

8.1.2 Constant transformation factors

Norris (1959) also states that, since the difference between the transformation factors in case of linear elastic and ideal plastic material is not great it is often permissible to use an average value of the transformation factors throughout the elastoplastic dynamic analysis.

This can be assumed to be valid also for trilinear material where the transformation factors thus are calculated as shown in Equation (8.1). However, it can be discussed if this is the best value to use in the analyses. The energy required to get motions of the system depends, among other quantities, on the mass. More energy is required to get motion of a heavy body than for a less heavy body. Since the equivalent mass becomes smaller when an average value of the transformation factors is used less energy will be consumed when starting the motion. This is here assumed to influence the results so much that it motivates to use the transformation factor for linear elastic material in the analyses. In the analyses made in Chapter 7 the applied transient load is active only in the elastic range which motivates the choice even more.

8.2 Discussion about FE models used in analyses

In Chapter 7 the time-displacement curve calculated by use of the simplified method of transforming beams into SDOF systems is compared with results from finite element analyses. This is made in order to verify the SDOF method. Even though there is not full agreement between the results the SDOF method is assumed to be results that are accurate enough. In these FE analyses the beams are modelled so that yielding will only occur in the points where the plastic hinges are assumed to form. However, in the reality, the zones with yielding are larger than just a point why this way of modelling the beams can be questioned.

If the simply supported beam subjected to a concentrated load, case(1.1), are modelled in the same way as in Section 7.1.2 but this time all elements have trilinear material behaviour the maximum midpoint displacement are almost twice the value achieved with the FE model used in the FE analyses in Chapter 7, see Figure 8.3.

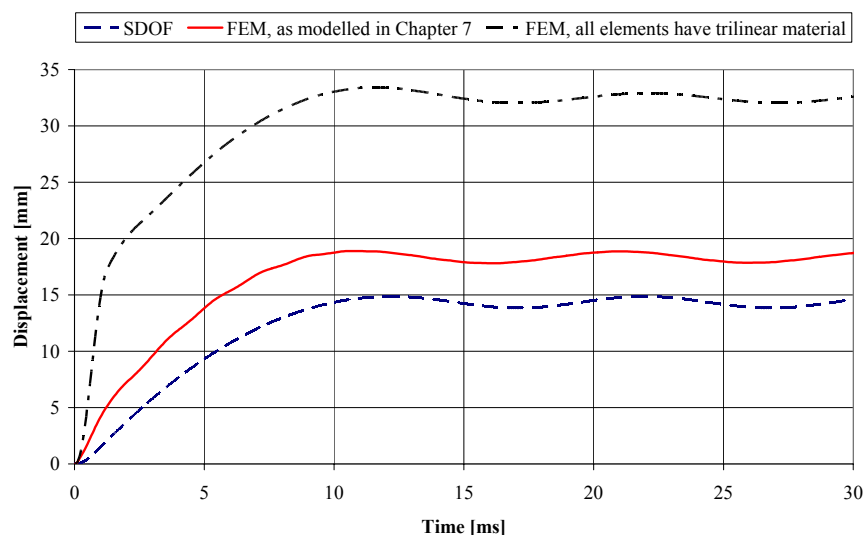

Figure 8.3 Time-displacement relation for case(1.1) from FE analyses where two different types of FE models are and the time-displacement curve from SDOF analyses.

The increased value of the maximum midpoint deflection can be explained by the fact that also elements around the midelement will reach the plastic range and will therefore achieve larger deformations. This is hence not a problem in case of linear elastic material or if the plastic range is not reached in case of trilinear material. The comparisons made in Chapter 7, when having plastic effects, can therefore be said to verify that the method of transforming deformable bodies into SDOF systems is rather well corresponding to the idealized reality rather than the “real” reality. This means that rather the assumptions made for plastic effects made in the SDOF analyses than the method it self shall be questioned.

This effect does not appear in case of uniformly distributed loads even though the plastic range is reached.

9 Pressure and impulse load acting on SDOF system

In this chapter the concepts of pressure and impulse load are shown and discussed. Let the loads act on a SDOF system, as shown in Figure 9.1, where damping is neglected. The SDOF system is assumed to be in equilibrium position (no movement) before the loading starts.

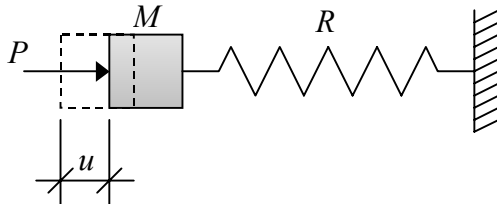

Figure 9.1 SDOF system with mass M , load P and internal force R .

In the case of pressure load the load will reach the maximum value instantaneously and keep this value for unlimited time. The impulse load increases and decreases instantaneously and the duration of time the load is applied is infinitely small. The small duration of the load time is compensated by a very high value of the load. Figure 9.2 illustrates the principals of the two extreme cases.

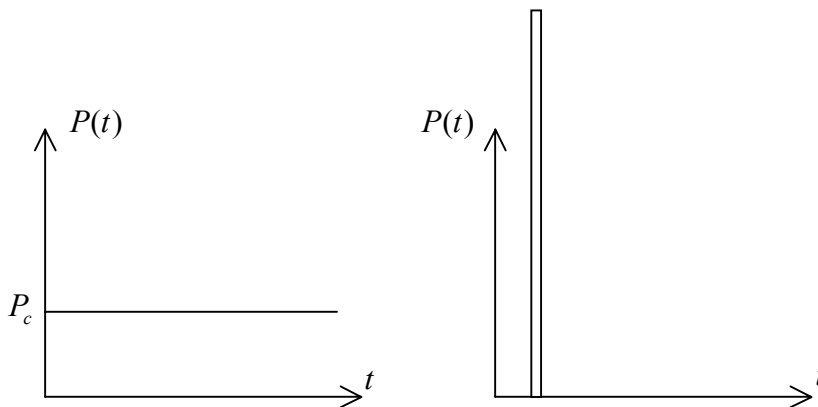

Figure 9.2 Characteristic pressure and impulse load respectively.

9.1 Pressure load

If a pressure load is acting on the system in Figure 9.1 the mass will move in the same direction as the load if the load is larger than the internal force. The system will accelerate as long as the value of the load is higher than the value of the internal force. Once the internal force equals the load the acceleration will stop and the system will achieve the maximum value of velocity. When the value of the internal force is higher

than the value of the load the retardation of the system starts. The maximum displacement is reached as the work performed by the external load equals the work carried out by the internal force, and the velocity then becomes zero. This course of events is shown in Figure 9.3.

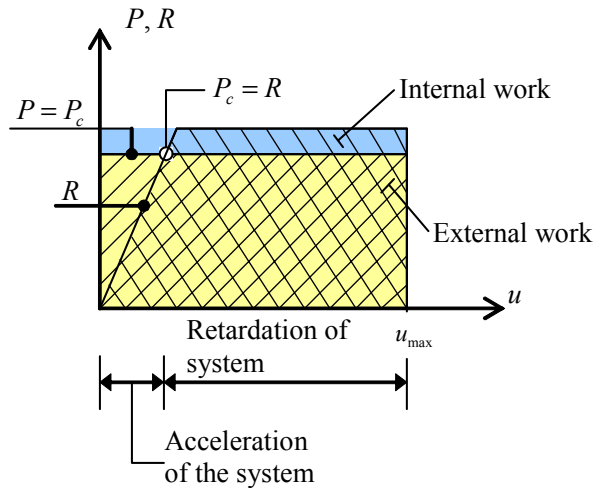

Figure 9.3 Internal and external work for SDOF system subjected to pressure load.

The expressions for external and internal work are used when deriving the maximum value of the characteristic pressure load, P_c , that the system can stand for an allowed maximum displacement u_{\max} . The maximum external and internal works are shown graphically as the areas in Figure 9.3 and the expressions for these areas are:

$$\Pi_{\text{internal}} = \int_{u=0}^{u=u_{\max}} R(u) du \quad (9.1)$$

$$\Pi_{\text{external}, P} = P_c u_{\max} \quad (9.2)$$

As the maximum displacement is reached, and the velocity becomes zero, the internal work equals the external work, meaning that Equation (9.1) equals (9.2). Using this relation and rearranging the terms the expression for the maximum load that the system can stand for a given value of the allowed maximum displacement is:

$$P_c = \frac{\int_{u=0}^{u=u_{\max}} R(u) du}{u_{\max}} \quad (9.3)$$

Hence, if a maximum displacement, u_{\max} , is allowed a maximum value of the pressure load according to Equation (9.3) is allowed.

9.2 Impulse load

For a characteristic impulse load, I_c , the system, with a mass M , obtains an instantaneous and maximum velocity. The expression of the velocity can be derived by using the second law of Newton that normally is expressed as:

$$P = M \cdot a \quad (9.4)$$

where

P	external load	[N]
M	mass	[kg]
a	acceleration	[m/s ²]

The acceleration can then be expressed (by rearranging the terms in Equation (9.4)) as:

$$a = \frac{P}{M} \quad (9.5)$$

By definition the acceleration is the first derivative of the velocity with respect to time and can be written as:

$$a = \frac{dv}{dt} (= \dot{v}) \quad (9.6)$$

Using Equations (9.5) and (9.6) gives:

$$\frac{dv}{dt} = \frac{P}{M} \Rightarrow v = \int_0^t \frac{P(t)}{M} dt \quad (9.7)$$

The mass is constant and the velocity can thus be expressed as:

$$v = \frac{1}{M} \int_0^t P(t) dt \quad (9.8)$$

The impulse is represented by the area under the load curve as shown in Figure 9.4 and is by definition:

$$I_c = \int_0^t P(t) dt \quad (9.9)$$

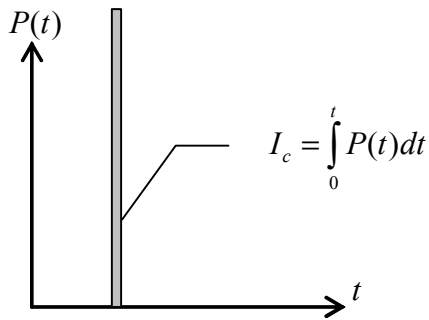

Figure 9.4 Characteristic impulse.

Since the load duration of a characteristic load is infinity short the instantaneous velocity can be expressed by means of Equations (9.8) and (9.9).

$$v = \frac{I_c}{M} \quad (9.10)$$

The characteristic impulse load is an idealized load not represented in the reality even though general impulse loads can resemble it. For these general impulse loads, where the load duration is not infinity short, the instantaneous velocity and hence the acceleration will depend also on the load-time relation.

After removal of the load, due to the internal resistance, the velocity decreases. When the velocity, and consequently the kinetic energy, becomes zero the maximum displacement, and consequently the maximum internal work, is reached. Initially, when the displacement of the system is zero and thus the potential energy is zero, the external work has a maximum value. So, all kinetic energy becomes potential energy when the maximum displacement is reached. The expressions for the maximum internal and external work are:

$$\Pi_{internal} = \int_{u=0}^{u=u_{max}} R(u) du \quad (9.11)$$

$$\Pi_{external,I} = \frac{Mv^2}{2} = \frac{M \left(\frac{I_c}{M} \right)^2}{2} = \frac{I_c^2}{2M} \quad (9.12)$$

For the maximum displacement Equation (9.11) equals Equation (9.12). Rearranging the terms gives the expression for the maximum value of the impulse load that the system can carry.

$$I_c = \sqrt{2 \int_{u=0}^{u=u_{max}} R(u) du} \cdot M \quad (9.13)$$

So, if a maximum displacement, u_{max} , is allowed a maximum value of the impulse load according to Equation (9.13) is allowed.

9.3 Determination of capacity for beams transformed to SDOF systems

When determining the capacity for a beam transformed to a SDOF system Equations (9.3) and (9.13) are used but with equivalent values as described in Section 6.1. Equations (9.3) and (9.13) expressed with equivalent internal force R_e , equivalent mass M_e , equivalent pressure load P_{ce} and equivalent impulse load I_{ce} become:

$$P_{ce} = \frac{\int_{u=0}^{u=u_{\max}} R_e(u) du}{u_{\max}} \quad (9.14)$$

$$I_{ce} = \sqrt{2 \int_{u=0}^{u=u_{\max}} R_e(u) du \cdot M_e} \quad (9.15)$$

where

$$P_{ce} = \kappa_P P_c \quad (9.16)$$

$$I_{ce} = \kappa_P I_c \quad (9.17)$$

$$R_e = \kappa_K R \quad (9.18)$$

$$M_e = \kappa_M M \quad (9.19)$$

and M is the total mass of the beam.

Equations (9.16) to (9.19) inserted in Equations (9.14) and (9.15) gives:

$$P_c = \kappa_{KP} \frac{\int_{u=0}^{u=u_{\max}} R(u) du}{u_{\max}} \quad (9.20)$$

$$I_c = \sqrt{2 \kappa_{KP} \int_{u=0}^{u=u_{\max}} R(u) du \cdot \kappa_{MP} M} \quad (9.21)$$

where as before $\kappa_{KP} = \kappa_K / \kappa_P$ and $\kappa_{MP} = \kappa_M / \kappa_P$.

9.3.1 Linear elastic material

For a linear elastic material the internal force, R , varies linearly with the displacement, u , as shown in Figure 9.5 and is expressed as:

$$\begin{aligned} R &= Ku \\ R_m &= Ku_{\max} \end{aligned} \quad (9.22)$$

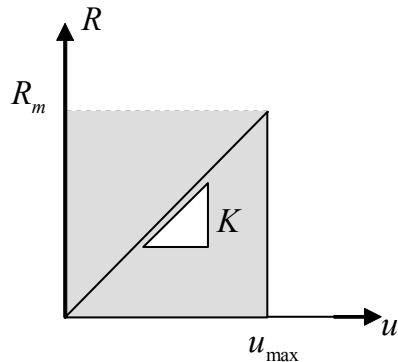

Figure 9.5 Internal force for linear elastic material.

The integral in Equations (9.20) and (9.21) is here represented by the shaded area in Figure 9.5:

$$\int_{u=0}^{u=u_{\max}} R(u) du = \frac{Ku_{\max}^2}{2} \quad (9.23)$$

By use of Equations (9.20), (9.21) and (9.23) the expressions for the pressure load and impulse load that the system can endure for a certain value of the allowed maximum displacement can be written as:

$$P_c = \kappa_{KP} \frac{Ku_{\max}^2}{2u_{\max}} = \kappa_{KP} \frac{Ku_{\max}}{2} = \kappa_{KP} \frac{R_m}{2} \quad (9.24)$$

$$I_c = \sqrt{2\kappa_{KP} \frac{Ku_{\max}^2}{2} \kappa_{MP} M} = \sqrt{\kappa_{KP} \kappa_{MP}} \sqrt{\frac{M}{K} R_m^2} = \sqrt{\kappa_{KP} \kappa_{MP}} \frac{R_m}{\omega} \quad (9.25)$$

where $\omega = \sqrt{K/M}$ is the circular frequency of the SDOF system.

In Figure 9.5 it can be seen that in case of linear elastic material the maximum displacement, u_{\max} , can be expressed as:

$$u_{\max} = \frac{R_m}{K} \quad (9.26)$$

Rearranging the terms in Equations (9.24) and (9.25) and using Equation (9.26) gives the expressions for the maximum displacement, u_{\max} , with respect to the pressure load and impulse load respectively.

$$u_{\max}(P_c) = \frac{R_m(P_c)}{K} = \frac{2P_c}{\kappa_{KP}K} \quad (9.27)$$

$$u_{\max}(I_c) = \frac{R_m(I_c)}{K} = \frac{I_c \sqrt{K/M} / \sqrt{\kappa_{KP}\kappa_{MP}}}{K} = \frac{1}{\sqrt{\kappa_{KP}\kappa_{MP}}} \frac{I_c}{M\omega} \quad (9.28)$$

9.3.2 Ideal plastic material

For an ideal plastic material the internal force, R , is constantly equal to the maximum internal force, R_m , when the displacement, u , is nonzero, as shown in Figure 9.6.

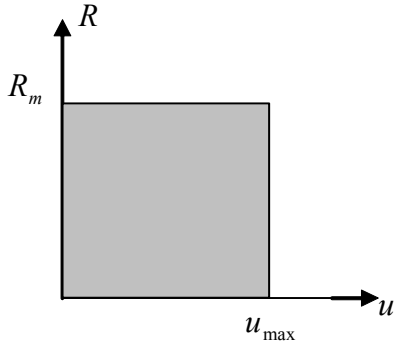

Figure 9.6 Internal force for ideal plastic material.

The integral in Equations (9.20) and (9.21) is here represented by the shaded area in Figure 9.6:

$$\int_{u=0}^{u=u_{\max}} R(u) du = R_m u_{\max} \quad (9.29)$$

By use of Equations (9.20), (9.21) and (9.29) the expressions for the pressure load and impulse load that the system can stand for a certain value of the allowed maximum displacement can be written as:

$$P_c = \kappa_{KP} \frac{R_m u_{\max}}{u_{\max}} = \kappa_{KP} R_m \quad (9.30)$$

$$I_c = \sqrt{2\kappa_{KP} R_m u_{\max} \kappa_{MP} M} = \sqrt{\kappa_{KP} \kappa_{MP}} \sqrt{2R_m u_{\max} M} \quad (9.31)$$

In case of ideal plastic material the maximum displacement, u_{\max} , cannot be expressed with respect to the pressure load as in case of linear elastic material. However, by

using Equation (9.31) the maximum displacement, u_{\max} , can be expressed with respect to the impulse load.

$$u_{\max}(I_c) = \frac{I_c^2}{\kappa_{KP} \kappa_{MP} 2R_m M} \quad (9.32)$$

9.3.3 Summary of capacity for beams transformed to SDOF systems

The capacity of an equivalent SDOF system subjected to pressure and impulse load are determined for linear elastic material and ideal plastic material respectively. For a general shape of the deflection the beam equations are shown in Table 9.1.

Table 9.1 General beam equations.

I. Linear elastic material	
$P_c = \kappa_{KP} \frac{R_m}{2}$	(a)
$I_c = \sqrt{\kappa_{KP} \kappa_{MP}} \frac{R_m}{\sqrt{K/M}}$	(b)
$u_{\max}(P_c) = \frac{1}{\kappa_{KP}} \frac{2P_c}{K}$	(c)
$u_{\max}(I_c) = \frac{1}{\sqrt{\kappa_{KP} \kappa_{MP}}} \frac{I_c}{\sqrt{KM}}$	(d)
II. Ideal plastic material	
$P_c = \kappa_{KP} R_m$	(e)
$I_c = \sqrt{\kappa_{KP} \kappa_{MP}} \sqrt{2R_m u_{\max} M}$	(f)
$u_{\max}(I_c) = \frac{1}{\kappa_{KP} \kappa_{MP}} \frac{I_c^2}{2R_m M}$	(g)

In Appendix G the expressions in Table 9.1 are developed for a simply supported beam as well as for a beam fixed in both ends subjected to a concentrated and uniformly distributed load.

9.4 Capacity for SDOF systems

The equations in Table 9.1 can be written in a general form for a SDOF system by letting the equivalent values of the quantities be equal to the actual values.

$$M_e = M \quad (9.33)$$

$$R_e = R \quad (9.34)$$

$$P_e = P \quad (9.35)$$

Meaning that the transformation factors κ in Table 9.1 shall be 1.0 (compare to Equations (9.16) to (9.19)). The general equations for SDOF systems are shown in Table 9.2.

Table 9.2 General equations for SDOF system

I. Linear elastic material	
$P_c = \frac{R_m}{2} = \frac{Ku}{2}$	(a)
$I_c = \frac{R_m}{\sqrt{K/M}}$	(b)
$u_{\max}(P_c) = \frac{2P_c}{K}$	(c)
$u_{\max}(I_c) = \frac{I_c}{\sqrt{KM}}$	(d)
II. Ideal plastic material	
$P_c = R_m$	(e)
$I_c = \sqrt{2R_m u_{\max} M}$	(f)
$u_{\max}(I_c) = \frac{I_c^2}{2R_m M}$	(g)

The relation between the pressure load P_c and the impulse load I_c can be expressed for the different materials. In case of linear elastic material the fact that the maximum displacement u_{\max} shall be equal for the two loads can be used.

$$u_{\max}(P_c) = u_{\max}(I_c) \quad (9.36)$$

Using (c) and (d) in Table 9.2 and using the circular frequency of vibration ω the relation between P_c and I_c in the linear elastic case can be expressed.

$$\omega = \sqrt{\frac{K}{M}} \quad \text{where } K \text{ is the stiffness and } M \text{ is the mass} \quad (9.37)$$

$$P_c = I_c \frac{\omega}{2} \Leftrightarrow I_c = P_c \frac{2}{\omega} \quad (9.38)$$

In case of ideal plastic material the pressure load P_c must be equal to the maximum value of the internal force R_m if the system shall move. Using Equations (e) and (f) in Table 9.2 gives the relation between P_c and I_c for ideal plastic material.

$$I_c = \sqrt{2P_c u_{\max} M} \Leftrightarrow P_c = \frac{I_c^2}{2u_{\max} M} \quad (9.39)$$

where $u_{\max} = u_{\max}(I_c)$.

10 Equivalent static load

In order to simplify the analysis of a structure subjected to an impulse load the load can be transformed to a static equivalent load. This means a static load chosen in such a way that it will result in the same maximum displacement as the impulse load.

As discussed in Section 9.2 the total energy, kinetic energy plus potential energy, for an undamped structure subjected to a dynamic load is constant. If the velocity (consequently also the kinetic energy) is zero the potential energy, as well as the displacement, has a maximum value. Even though it takes a while before the maximum velocity is reached when a dynamic load is applied it can be assumed that the maximum value of the kinetic energy occurs when the displacement is zero. This is at least a good approximation for a hard, short impulse loads. Hence, the maximum value of the kinetic energy equals the maximal value of the potential energy. In case of a static load there is only potential energy (no kinetic energy).

Due to the condition that the displacement in case of a static load must equal the maximum displacement for the dynamic load the potential energy in the static case must equal the maximum potential energy for the dynamic load. Using this statement together with the statement made above gives:

$$\text{Potential energy for static case} = \text{Maximum kinetic energy for dynamic case} \quad (10.1)$$

From this statement the expression of the equivalent static load P^{static} can be defined with respect to the characteristic impulse load I_c .

10.1 SDOF system

An SDOF system subjected to an impulse load will achieve vibrations and the instantaneous velocity, caused by a characteristic impulse load, derived in Section 9.2, is for a load, regarded as an impulse load, written as:

$$v = \frac{I}{M} \quad (10.2)$$

The maximum value of the kinetic energy is thus:

$$W_k = \frac{Mv^2}{2} = \frac{M}{2} \left(\frac{I}{M} \right)^2 = \frac{I^2}{2M} \quad (10.3)$$

By means of the equations above the external work (the work due to the impulse) can be expressed as the difference in kinetic energy from time to time.

$$\Pi_{external,I} = \frac{I_2^2 - I_1^2}{2M} \quad (10.4)$$

The maximum external work equals the maximum kinetic energy since the system is at rest before the load is applied, $v_1 = 0$ and $v_2 = v = v_{max}$, and therefore has no initial kinetic energy:

$$\Pi_{external,I} = \frac{I_2^2}{2M} = \{I_2 = I\} = \frac{I^2}{2M} \quad (10.5)$$

The increase of work, $d\Pi_{external,P^{static}}$, of the external static load causing a differential displacement du , for a system subjected to the static load P^{static} can be expressed as:

$$d\Pi_{external,P^{static}} = P^{static} \cdot du \quad (10.6)$$

By integrating Equation (10.6) over the total displacement the total work of the external static load is achieved.

$$\Pi_{external,P^{static}} = \int_{u=0}^{u=u} P^{static} du \quad (10.7)$$

The expression for the total work of the load will be different for different materials.

10.1.1 Linear elastic material

In case of linear elastic material the static external load, P^{static} , can be expressed by use of the stiffness, K , and the displacement u from the unloaded equilibrium position.

$$P^{static} = K \cdot u \quad (10.8)$$

Equations (10.7) and (10.8) give the total work of the external static load as:

$$\Pi_{external,P^{static}} = \int_{u=0}^{u=u} P^{static} du = \int_{u=0}^{u=u} Ku \cdot du = \frac{Ku^2}{2} \quad (10.9)$$

The total work of the external static load in Equation (10.9) shall be equal to the work of motion caused by the impulse load in Equation (10.5).

$$\frac{Ku^2}{2} = \frac{I^2}{2M} \Rightarrow \frac{(P^{static})^2}{K} = \frac{I^2}{M} \quad (10.10)$$

The static load equivalent to the impulse load acting on a SDOF system, with linear elastic behaviour, can now be expressed as:

$$P_{SDOF}^{static} = \sqrt{\frac{K}{M}} I = \omega I \quad (10.11)$$

where ω is the circular frequency of the SDOF system.

10.1.2 Ideal plastic material

In case of a SDOF system with ideal plastic behaviour subjected to a constant load P^{static} the displacement will go from 0 to u and the total external work can be expressed by use of Equation (10.7).

$$\Pi_{external, P^{static}} = \int_{u=0}^{u=u} P^{static} du = P^{static} \cdot u \quad (10.12)$$

The total work of the external static load in Equation (10.12) shall be equal to the work of motion, caused by the impulse load in Equation (10.5).

$$P^{static} \cdot u = \frac{I^2}{2M} \quad (10.13)$$

The static load equivalent to the impulse load acting on a SDOF system, with ideal plastic behaviour, can now be expressed as:

$$P_{SDOF}^{static} = \frac{I^2}{2M \cdot u} \quad (10.14)$$

10.2 Beams

For beams the method of transforming the beams into SDOF systems shown in Chapter 6 is used. The expressions for the equivalent static load for beams are derived in the same manner as for the SDOF system (see Sections 10.1.1 and 10.1.2) but equivalent values of the mass, M , the internal force, R , and the external load, P , are used. The equivalent values of the mass, stiffness and external load are noted as M_e , R_e and P_e and are in Chapter 6 defined as:

$$M_e = \kappa_M M_{beam} \quad (10.15)$$

$$R_e = \kappa_K R_{beam} \quad (10.16)$$

$$P_e = \kappa_P P_{beam} \quad (10.17)$$

The transformation factors, κ , have different values depending on material and assumed shape of deformation and are shown in Table 6.1 for linear elastic and ideal plastic material.

The internal stiffness of the beam, K_{beam} , can be expressed as:

$$K_{beam} = \frac{1}{u_s(t)} \int_{x=0}^{x=L} q(x,t) dx \quad (10.18)$$

If the uniformly distributed load $q(x,t)$ is varying in time the distributed impulse, i [Ns/m], can be expressed as:

$$i = \int_{t=t_1}^{t=t_2} q(x,t) dt \quad (10.19)$$

The total impulse acting on the beam is:

$$I = \int_{x=0}^{x=L} i dx = \int_{x=0}^{x=L} \int_{t=t_1}^{t=t_2} q(x,t) dt dx \quad (10.20)$$

10.2.1 Linear elastic material

In case of linear elastic material the equivalent static load, to a general impulse load, acting on a SDOF system is determined by inserting Equations (10.15) to (10.17) and (10.20) into Equation (10.11).

$$P_{SDOF}^{static} = \sqrt{\frac{K_e}{M_e}} I_e = \sqrt{\frac{\kappa_K K_{beam}}{\kappa_M M_{beam}}} \kappa_P I = \sqrt{\frac{\kappa_K K_{beam}}{\kappa_M M_{beam}}} \kappa_P \int_{x=0}^{x=L} \int_{t=t_1}^{t=t_2} q(x,t) dt dx \quad (10.21)$$

where transformation factors for linear elastic behaviour shall be used.

The beam capacity can also be analysed by using an, to the general impulse load, equivalent static load directly on the beam. If this equivalent static load is a concentrated load acting in the system point the expression is:

$$P_{beam}^{static} = \frac{P_{SDOF}^{static}}{\kappa_P} = \sqrt{\frac{\kappa_K K_{beam}}{\kappa_M M_{beam}}} \int_{x=0}^{x=L} \int_{t=t_1}^{t=t_2} q(x,t) dt dx \quad (10.22)$$

If the equivalent static load is a uniformly distributed load acting on the beam the expression is:

$$q_{beam}^{static} = \frac{P_{beam}^{static}}{\kappa_P L} = \frac{1}{L} \sqrt{\frac{\kappa_K K_{beam}}{\kappa_M M_{beam}}} \int_{x=0}^{x=L} \int_{t=t_1}^{t=t_2} q(x,t) dt dx \quad (10.23)$$

If the impulse load is a concentrated load the impulse can be written as:

$$I = \int_{t=t_1}^{t=t_2} P(t) dt \quad (10.24)$$

and Equations (10.22) can be expressed as:

$$P_{beam}^{static} = \frac{P_{SDOF}^{static}}{\kappa_P} = \sqrt{\frac{\kappa_K K_{beam}}{\kappa_M M_{beam}}} \int_{t=t_1}^{t=t_2} P(t) dt \quad (10.25)$$

If the impulse load is a uniformly distributed load the impulse can be written as:

$$I = L \int_{t=t_1}^{t=t_2} q(t) dt \quad (10.26)$$

and Equations (10.23) can be expressed as:

$$q_{beam}^{static} = \sqrt{\frac{\kappa_K K_{beam}}{\kappa_M M_{beam}}} \int_{t=t_1}^{t=t_2} q(t) dt \quad (10.27)$$

10.2.2 Ideal plastic material

In case of ideal plastic material the equivalent static load, to a general impulse load, acting on a SDOF system is determined by inserting Equations (10.15), (10.17) and (10.20) into Equation (10.14).

$$P_{SDOF}^{static} = \frac{I_e^2}{2M_e \cdot u_{max}} = \frac{1}{2\kappa_M M \cdot u_{max}} \left(\kappa_P \int_{x=0}^{x=L} \int_{t=t_1}^{t=t_2} q(x,t) dt dx \right)^2 \quad (10.28)$$

where transformation factors for ideal plastic behaviour shall be used.

The beam capacity can also be analysed by using an, to the general impulse load, equivalent static load directly on the beam. If this equivalent static load is a concentrated load acting in the system point the expression is:

$$P_{beam}^{static} = \frac{P_{SDOF}^{static}}{\kappa_P} = \frac{\kappa_P}{2\kappa_M M \cdot u_{max}} \left(\int_{x=0}^{x=L} \int_{t=t_1}^{t=t_2} q(x,t) dt dx \right)^2 \quad (10.29)$$

If the equivalent static load is a uniformly distributed load acting on the beam the expression is:

$$q_{beam}^{static} = \frac{P_{beam}^{static}}{\kappa_P L} = \frac{1}{L} \frac{\kappa_P}{2\kappa_M M \cdot u_{max}} \left(\int_{x=0}^{x=L} \int_{t=t_1}^{t=t_2} q(x,t) dt dx \right)^2 \quad (10.30)$$

If the impulse load is a concentrated load the impulse can be written as:

$$I = \int_{t=t_1}^{t=t_2} P(t) dt \quad (10.31)$$

and Equation (10.30) can be expressed as:

$$P_{beam}^{static} = \frac{\kappa_P}{2\kappa_M M \cdot u_{max}} \left(\int_{t=t_1}^{t=t_2} P(t) dt \right)^2 \quad (10.32)$$

If the impulse load is a uniformly distributed load the impulse can be written as:

$$I = L \int_{t=t_1}^{t=t_2} q(t) dt \quad (10.33)$$

and Equation (10.31) can be expressed as:

$$q_{beam}^{static} = \frac{\kappa_P \cdot L}{2\kappa_M M \cdot u_{max}} \left(\int_{t=t_1}^{t=t_2} q(t) dt \right)^2 \quad (10.34)$$

11 Damage curves

In Section 6.2.3 the relation between deformation and load are shown for the extreme load duration cases that is obtained when the system is subjected to a characteristic pressure and impulse load, respectively. In order to calculate this relation for a general load, as schematically shown in Figure 11.1 so called damage curves can be used.

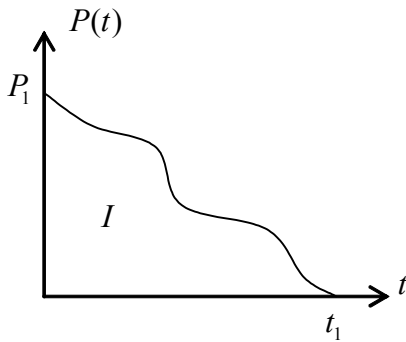

Figure 11.1 General load-time relation.

Damage curves are valid for an SDOF system or an equivalent SDOF system. In this chapter the notations of the quantities are written in a general form. If it is an equivalent SDOF system the following equations are valid:

$$P = P_e \quad (11.1)$$

$$R = R_e \quad (11.2)$$

$$M = M_e \quad (11.3)$$

Where the index e indicates that it is the equivalent value of the quantity.

11.1 Calculation equations

The differential equation for an SDOF system, when damping is neglected, is:

$$M\ddot{u} + R = P(t) \quad (11.4)$$

and can for a general case be solved by use of for example the central difference method described in Section 5.2.

Using the relative simplicity to analyse structures subjected to pressure load, P_c , and impulse load, I_c , the results from the general load case will be related to these results. So, if a structure can endure the extreme values P_c and I_c obtaining maximum deformation u_{\max} , the structure also will endure every general load (see Figure 11.1),

resulting in a displacement less or equal to u_{\max} . This discussion can be concluded in the following two equations, where f_p and f_I indicates functions and $f_p \neq f_I$.

$$\frac{I}{I_c} = f_p\left(\frac{P_1}{P_c}\right) \Leftrightarrow \frac{P_1}{P_c} = f_I\left(\frac{I}{I_c}\right) \quad (11.5)$$

The relation between I and I_c is called the impulse load factor and is written as:

$$\gamma_I = \frac{I}{I_c} \quad (11.6)$$

The relation between P_1 and P_c is called the pressure load factor and is written as:

$$\gamma_P = \frac{P_1}{P_c} \quad (11.7)$$

The strategy to calculate the impulse load factor and the pressure load factor are further discussed in Sections 11.1.1 and 11.1.2.

Calculations are here made for three different types of transient loads as shown in Figure 11.2. The expression for the loads are:

$$P(t) = P_1\left(1 - t/t_1\right)^n \quad (11.8)$$

where n is given in Figure 11.2.

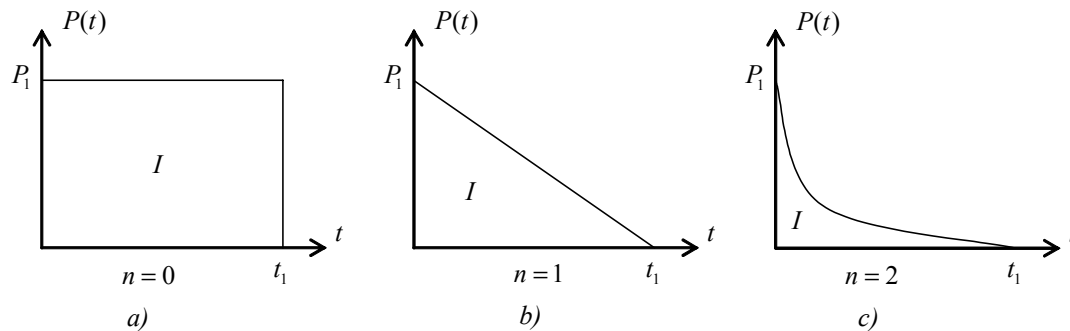

Figure 11.2 Transient loads; a) rectangular load b) triangular load and c) quadratic decreasing load.

11.1.1 Linear elastic material

In case of linear elastic material the internal resistance is proportional to the displacement, $R=Ku$ and Equation (11.4) can be written as:

$$M\ddot{u} + Ku = P(t) \quad (11.9)$$

11.1.1.1 γ_P known

When the pressure load factor γ_P and either P_c or P_I are known the value of the corresponding P_c or P_I can be calculated by use of Equation (11.7). I_c can be calculated with Equation (9.38).

$$I_c = P_c \frac{2}{\omega} \quad (11.10)$$

The time t_I for the general load can be calculated by solving Equation (11.9) with the central difference method (see Section 5.2) in an iterative process where the maximum displacement caused by the general load shall equal the maximum displacement due to the pressure load P_c , see Table 9.2:

$$u_{\max}(P_c) = \frac{2P_c}{K} \quad (11.11)$$

When the time t_I is calculated the impulse I is calculated as:

$$I = \int_{t=0}^{t=t_I} P(t) dt \quad (11.12)$$

For the rectangular load in Figure 11.2.a the impulse I is:

$$I = \int_{t=0}^{t=t_1} P_1(1 + t/t_1)^0 dt = \int_{t=0}^{t=t_1} P_1 dt = P_1 \cdot t_1 \quad (11.13)$$

The triangular load in Figure 11.2.b results in the impulse I :

$$I = \int_{t=0}^{t=t_1} P_1(1 + t/t_1)^1 dt = \int_{t=0}^{t=t_1} P_1(1 + t/t_1) dt = \frac{P_1 \cdot t_1}{2} \quad (11.14)$$

For the quadratic decreasing load in Figure 11.2.c the impulse I is:

$$I = \int_{t=0}^{t=t_1} P_1(1 + t/t_1)^2 dt = \frac{P_1 \cdot t_1}{3} \quad (11.15)$$

By using Equation (11.6) the impulse load factor γ_I can be calculated.

11.1.1.2 γ_I known

When the impulse load factor γ_I is known and either I_c or I_I are known the value of the corresponding I_c or I_I can be calculated by use of Equation (11.6). P_c can be calculated with Equation (9.38).

$$P_c = I_c \frac{\omega}{2} \quad (11.16)$$

The time t_l for the general load can be calculated by solving Equation (11.9) with the central difference method (see Section 5.2) in an iterative process where the maximum displacement caused by the general load shall equal the maximum displacement due to the impulse load I_c , see Table 9.2:

$$u_{\max}(I_c) = \frac{I_c}{\sqrt{KM}} \quad (11.17)$$

The maximum value of the general load P_l is not known in the iterative process but the relation between P_l and the impulse is known for the different load cases (see Equation (11.12)). For the rectangular load in Figure 11.2.a the maximum value P_l of the transient load is, see Equation (11.13):

$$P_l = \frac{I}{t_1} \quad (11.18)$$

The maximum value of the transient load in Figure 11.2.b is, see Equation (11.14):

$$P_l = \frac{2I}{t_1} \quad (11.19)$$

For the quadratic decreasing load in Figure 11.2.c the maximum value of the load is, see Equation (11.15):

$$P_l = \frac{3I}{t_1} \quad (11.20)$$

When the time t_l and the corresponding value of P_l are known Equation (11.7) is used to calculate the impulse load factor γ_p .

11.1.2 Ideal plastic material

In case of ideal plastic material the internal force has a constant value, $R=R_m$ if $P_l \geq R_m$ and if $u \neq 0$ and Equation (11.4) can be written as:

$$M\ddot{u} + R_m = P(t) \quad (11.21)$$

If $P_l < R_m$ there will be no motion ($u = 0$ for all times) since Equation (11.4) is then:

$$M\ddot{u} = 0 \quad (11.22)$$

The characteristic value of the pressure load P_c equals the maximum value of the internal force R_m in case of ideal plastic material.

11.1.2.1 γ_P known

The relation between γ_P and γ_I is definite determined so when γ_P and I_c is known the maximum displacement u_{\max} can be calculated by use of Equation (g) in Table 9.2:

$$u_{\max}(I_c) = \frac{I_c^2}{2R_m M} \quad (11.23)$$

Observe that $u_{\max}(P_c)$ is undefined.

Solve, by means of an iterative process, the load duration time t_I with Equations (11.18) to (11.20) so $u_{\max}(P_I, t_I)$ equals $u_{\max}(I_c)$. Now the value of I is calculated by inserting t_I into Equations (11.18) to (11.20). By using Equation (11.6) the impulse load factor γ_I can be calculated.

11.1.2.2 γ_I known

When the impulse load factor γ_I is known and either I_c or I_I are known the value of the corresponding I_c or I_I can be calculated by use of Equation (11.6). The maximum displacement u_{\max} can be calculated by use of Equation (g) in Table 9.2:

$$u_{\max}(I_c) = \frac{I_c^2}{2R_m M} \quad (11.24)$$

The time t_I for the general load can be calculated by solving Equation (11.9) with the central difference method (see Section 5.2) in an iterative process where the maximum displacement caused by the general load shall equal the maximum displacement due to the impulse load I_c , see Equation (11.16) and Table 9.2:

The maximum value of the general load P_I is not known in the iterative process but the relation between P_I and the impulse is known for the different load cases (see Equation (11.12)). The maximum value P_I of the loads, shown in Figure 11.2, are calculated in the same way as in case of linear elastic material, see Equations (11.18) to (11.20).

When the time t_I and the corresponding value of P_I are known Equation (11.7) is used to calculate the impulse load factor γ_P .

11.2 Results

Table 11.1 and Table 11.2 show the relation between the pressure factor and the impulse factor for the three transient load cases shown in Figure 11.2 when having linear elastic and ideal plastic behaviour, respectively. In Appendix H more complete

tables of damage are shown, see Table H.1 and Table H.2, the values in Table 11.1 and Table 11.2 are extracts from these.

The tables says that if a certain allowed displacement u is wanted and the characteristic pressure load P_c and impulse load I_c result in this displacement the maximum allowed value of the impulse I can be estimated if the maximum value of the load P_I is known and vice versa. For example:

- If P_I is allowed to be 2 times larger than P_c ($\gamma_P = 2$) the maximum, allowed value of the impulse is $I = \gamma_I \cdot I_c = 1.166 \cdot I_c$ in case of linear elastic and triangularly decreasing load ($n=1$).
- In the same way; the maximum value of P_I is allowed to be $P_I = \gamma_P \cdot P_c = 1.269 \cdot P_c$ if the impulse I is allowed to be 5 times larger than I_c ($\gamma_I = 5$) in case of ideal plastic material and triangularly decreasing load ($n=1$).

Table 11.1 Relation between γ_P and γ_I for linear elastic and ideal plastic material respectively when γ_P is known.

$\gamma_P = \frac{P_I}{P_c}$	$\gamma_I = \frac{I}{I_c}$					
	Linear elastic behaviour			Ideal plastic behaviour		
	$n=0$	$n=1$	$n=2$	$n=0$	$n=1$	$n=2$
1.01	1.444	41.13	65.15	10.05	441.8	587.5
1.05	1.324	8.491	11.17	4.583	42.87	56.25
1.1	1.255	4.570	5.931	3.317	16.57	21.58
1.5	1.095	1.490	1.776	1.732	2.756	3.330
2	1.047	1.166	1.293	1.414	1.732	1.957
3	1.020	1.057	1.094	1.225	1.342	1.414
5	1.007	1.019	1.029	1.118	1.168	1.196
10	1.002	1.005	1.007	1.054	1.074	1.085
100	1.000	1.000	1.000	1.005	1.001	1.007

Table 11.2 Relation between γ_P and γ_I for linear elastic and ideal plastic material respectively when γ_I is known.

$\gamma_I = \frac{I}{I_c}$	$\gamma_P = \frac{P_1}{P_c}$					
	Linear elastic behaviour			Ideal plastic behaviour		
	$n=0$	$n=1$	$n=2$	$n=0$	$n=1$	$n=2$
1.01	4.144	6.813	8.525	50.72	67.67	76.13
1.05	1.959	3.177	3.911	10.76	14.34	16.14
1.1	1.469	2.389	2.924	5.763	7.688	8.645
1.3	1.066	1.691	1.984	2.452	3.269	3.678
1.5	1.003	1.493	1.694	1.800	2.400	2.700
2	1.000	1.296	1.409	1.333	1.775	1.966
3	1.000	1.167	1.228	1.125	1.453	1.562
5	1.000	1.090	1.122	1.042	1.269	1.367
10	1.000	1.042	1.056	1.010	1.148	1.182
100	1.000	1.005	1.013	1.001	1.028	1.034

Figure 11.3 and Figure 11.4 show the tables of damage, Table 11.1 and Table 11.2, graphically for the transient loads in Figure 11.2 for linear elastic and ideal plastic material respectively. The diagrams are called damage curves.

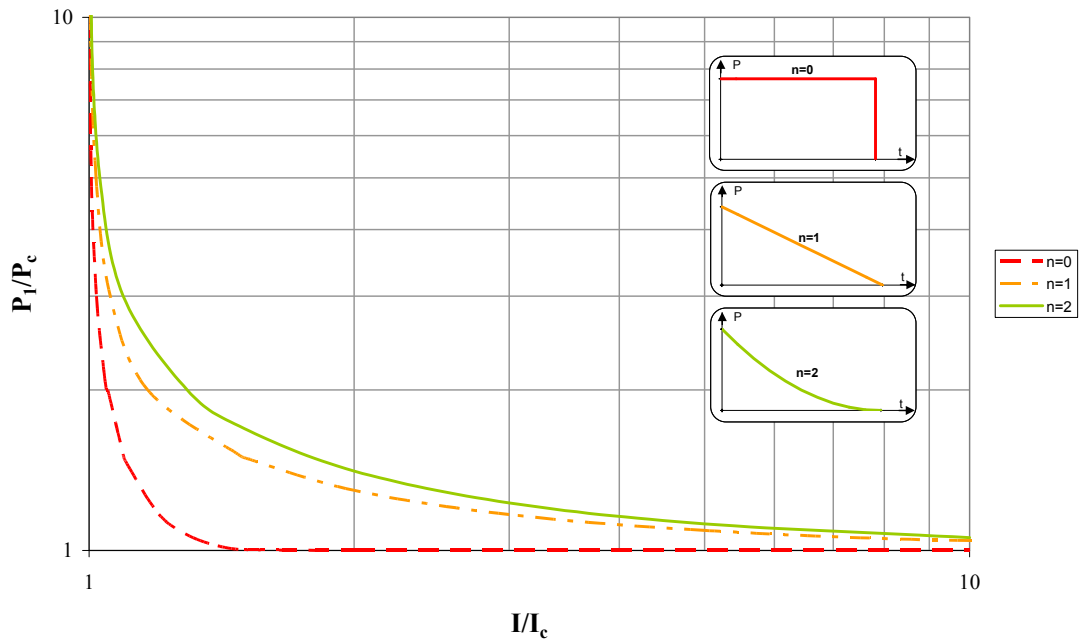

Figure 11.3 Damage curves for rectangular load pulse ($n=0$), triangular load pulse ($n=1$) and quadratic decreasing load pulse ($n=2$) in case of linear elastic material

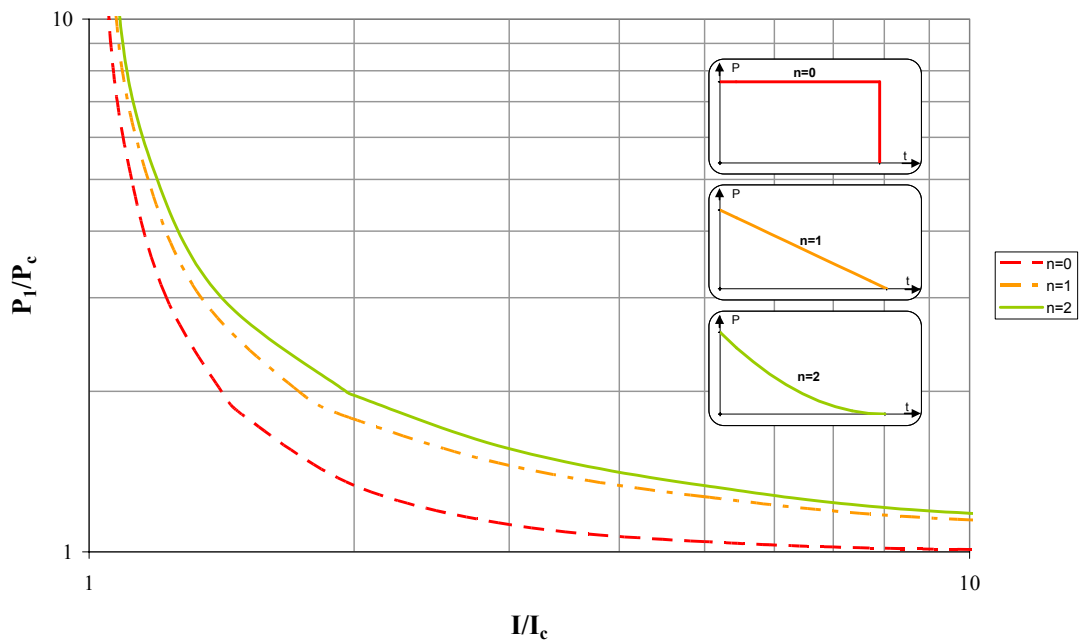

Figure 11.4 Damage curves for rectangular load pulse ($n=0$), triangular load pulse ($n=1$) and quadratic decreasing load pulse ($n=2$) in case of ideal plastic behaviour

11.3 Practical use of tables of damage

11.3.1 Solution process

In practise, different inputs are known when using the tables of damage. Here some different cases are discussed.

The approach is the same for linear elastic material and ideal plastic material. The relation between γ_P and γ_I (and thus P_1/P_c and I/I_c) in case of linear elastic material and ideal plastic material are shown in Table H.1 and Table H.2 in Appendix H, extracts from these tables are shown in Table 11.1 and Table 11.2.

Known: P_1 , P_c and thus also I_c

Searched: allowed load duration time t_1

- a. The pressure load factor γ_P is calculated, $\gamma_P = P_1/P_c$
- b. The corresponding value of γ_I are determined by means of tables of damage.
- c. I are determined from $I = I_c \cdot \gamma_I$
- d. The allowed load duration time t_1 is calculated by use of $I = \int_{t=0}^{t_1} P(t) dt$

Known: I_c , I and thus also P_c

Searched: allowed load duration time t_1

- a. The pressure load factor γ_I is calculated, $\gamma_I = I/I_c$
- b. The corresponding value of γ_P are determined by means of tables of damage.
- c. P_1 are determined from $P_1 = P_c \cdot \gamma_P$
- d. The allowed load duration time t_1 is calculated by use of $I = \int_{t=0}^{t_1} P(t) dt$

Known: P_1 , t_1 , γ_I and $I_c/P_c = 2/\omega$

Searched: P_c and I_c (see also example below)

- a. Calculate the impulse, $I = \int_{t=0}^{t_1} P(t) dt$

- b. Determine a value of $\frac{\gamma_I}{\gamma_P} = \frac{I}{I_c} \cdot \frac{P_c}{P_1}$ where the relation between I and P_1 are found in point a. above
- c. Find in the tables of damage (Appendix H) a combination of γ_I and γ_P fulfilling $\frac{\gamma_I}{\gamma_P}$ in point b. above
- d. Calculate $I_c = \frac{I}{\gamma_I}$ and $P_c = \frac{P_1}{\gamma_P}$ (in order to check the results it can be controlled if $I_c/P_c = 2/\omega$ and if $u_{\max}(I_c) = u_{\max}(P_c)$)

11.3.2 Example

Assume linear elastic material and that P_1 , t_1 and $P_c/I_c = 2/\omega$ are known and search for P_c and I_c . The beam for which the characteristic pressure and impulse load shall be calculated is the reinforced fixed concrete beam subjected to a uniformly distributed load used in Chapter 7, with density $\rho=2400 \text{ kg/m}^3$. This beam is also analysed in Appendix D, Section D.2.4, where the values of the stiffness K is calculated. Since linear elastic material is assumed these transformation factors are used, see Table 6.1. The load and load duration t_1 represents an, to the equivalent static load $q=50 \text{ kN/m}^2$ from the Swedish shelter regulations, R ddningsverket (2003), approximated transient load.

$$P_1 = 12500 \text{ kN}, \quad t_1 = 1.12 \text{ ms}, \quad M = b \cdot h \cdot L \cdot \rho = 1.0 \cdot 0.35 \cdot 2.5 \cdot 2400 = 2100 \text{ kg},$$

$$\omega = \sqrt{\frac{\kappa_{KP}^{el} K}{\kappa_{MP}^{el} M}} = \sqrt{\frac{1.0 \cdot 3392 \cdot 10^6}{0.762 \cdot 2100}} = 1456 \text{ rad/s}$$

The approximated transient load is assumed to be triangular in time (as shown in Figure 11.2.b).

$$P(t) = P_1 \left(1 - \frac{t}{t_1} \right)$$

- a. The impulse I is calculated:

$$I = \int_0^{t_1} P(t) dt = \int_0^{t_1} P_1 \left(1 - \frac{t}{t_1} \right) dt = \frac{P_1 \cdot t_1}{2} = \frac{12500 \cdot 1.12}{2} = 7000 \text{ Ns}$$

- b. The relation $\frac{\gamma_I}{\gamma_P}$ is:

$$\frac{\gamma_I}{\gamma_P} = \frac{I}{P_1} \cdot \frac{P_c}{I_c} = \frac{I}{P_1} \cdot \frac{\omega}{2} = \frac{7000 \cdot 1456}{12500 \cdot 10^3 \cdot 2} = 0.408$$

- c. Search in the tables of damage for linear elastic material (see Appendix H) for a combination of γ_I and γ_P fulfilling $\frac{\gamma_I}{\gamma_P} = 0.408$.

In Table H.1 in Appendix H it can be seen that γ_I is in between 2.6 and 2.8 since $\frac{\gamma_I}{\gamma_P} = 0.4154$ when $\gamma_P = 2.6$ and $\frac{\gamma_I}{\gamma_P} = 0.3812$ when $\gamma_P = 2.8$. Linear variation is assumed in between these values (as shown in Figure 11.5) and the values of γ_I and γ_P can be calculated as:

$$\gamma_I = \frac{\left(\frac{\gamma_I}{\gamma_P}\right)_{known} - \left(\frac{\gamma_I}{\gamma_P}\right)_{min}}{\left(\frac{\gamma_I}{\gamma_P}\right)_{max} - \left(\frac{\gamma_I}{\gamma_P}\right)_{min}} (\gamma_{I,max} - \gamma_{I,min}) + \gamma_{I,min} = \frac{0.408 - 0.381}{0.415 - 0.381} (1.08 - 1.07) + 1.07 = 1.08$$

$$\frac{\gamma_I}{\gamma_P} = 0.408 \Rightarrow \gamma_P = \frac{\gamma_I}{0.408} = \frac{1.08}{0.408} = 2.64$$

- d. The values of P_c and I_c can now be calculated:

$$P_c = \frac{P_1}{\gamma_P} = \frac{12500}{2.64} = 4735 \text{ kN}$$

$$I_c = \frac{I}{\gamma_I} = \frac{7000}{1.08} = 6500 \text{ Ns}$$

Checks:

$$\left. \begin{aligned} \frac{I_c}{P_c} &= \frac{6500}{4735 \cdot 10^3} = 1.37 \cdot 10^{-3} \\ \frac{2}{\omega} &= \frac{2}{1456} = 1.37 \cdot 10^{-3} \end{aligned} \right\} \Rightarrow \frac{I_c}{P_c} = \frac{2}{\omega}$$

$$\left. \begin{aligned} u_{max}(I_c) &= \frac{I_c}{\sqrt{K_e M_e}} = \frac{I_c}{\omega M_e} = \frac{6500}{1456 \cdot 1600} = 2.79 \text{ mm} \\ u_{max}(P_c) &= \frac{2P_c}{K_e} = \frac{2P_c}{\omega^2 M_e} = \frac{2 \cdot 4735 \cdot 10^3}{1456^2 \cdot 1600} = 2.79 \text{ mm} \end{aligned} \right\} \Rightarrow u_{max}(I_c) = u_{max}(P_c)$$

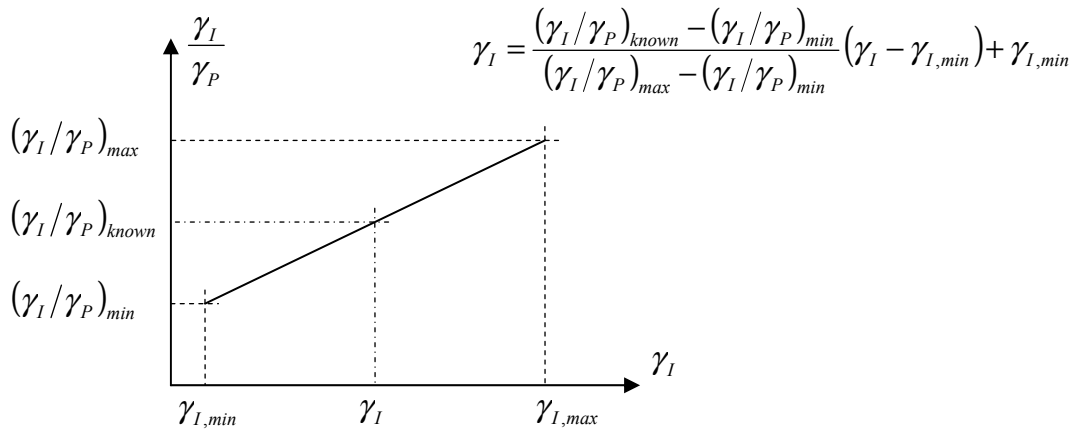

Figure 11.5 Linear variation is assumed between the values in Table H.1 in Appendix H.

11.4 Practical use of damage curves

11.4.1 Solution process

The damage curves can be used to determine the maximum impulse and pressure values of a general load corresponding to a certain maximum displacement u_{max} . This method can be apprehended as old-fashioned compared to other methods, especially today when computational tools are easily accessible, but it shows principally how general loads can be interpreted.

The characteristic impulse and pressure loads are calculated by means of u_{max} as shown in Section 9.4 and together they represent the characteristic point corresponding to the origin, $(\gamma_I, \gamma_P)=(1,1)$, in the damage curves above (see Figure 11.3 and Figure 11.4). One way to perform the analysis is shown:

- 1 Plot the damage curve of interest on a transparent paper, as shown in Figure 11.6. If the analysis is made on a computer no transparent papers are needed, instead the following points are performed directly in the computer.

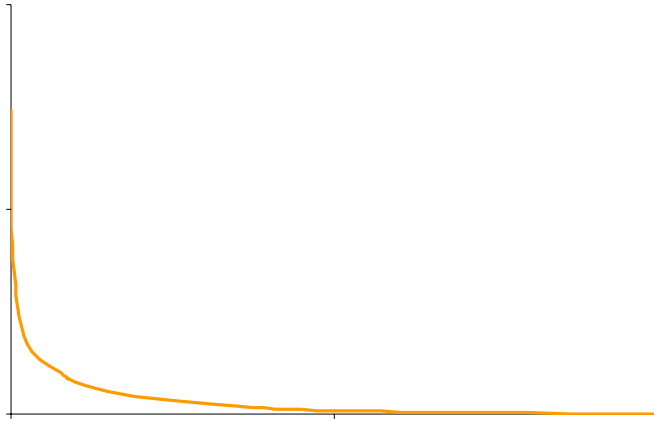

Figure 11.6 Diagram for linear elastic material and $n=1$, see Figure 11.3.

- 2 Plot coordinate axis, in the same scale as for point 1 above, on a new paper. The impulse load I shall be plotted on the horizontal axis and the maximum value of the pressure load P_l on the vertical axis. Diagonals shall also be drawn where I/P_l is constant. The diagonals in Figure 11.7 correspond to $t_l=(n+1) I/P_l$ where the load with $n=1$ is used, see Figure 11.2.

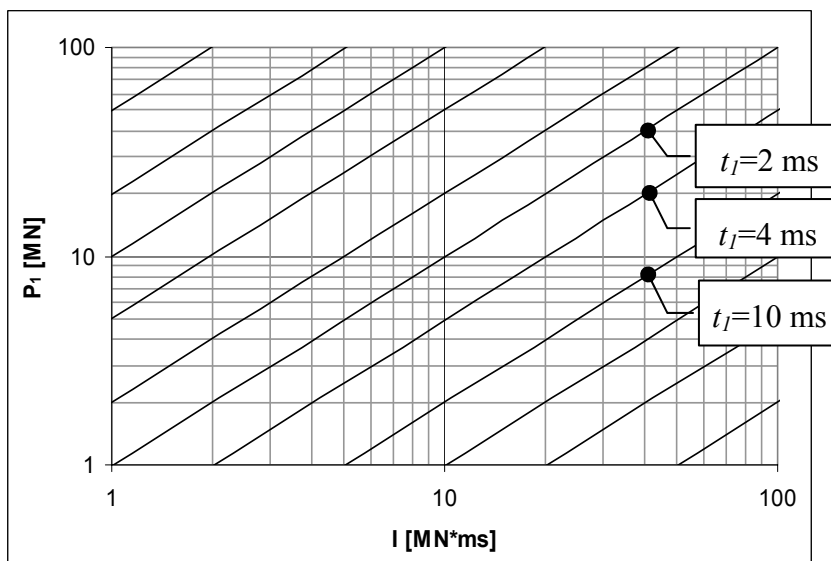

Figure 11.7 Diagram for damage curve with same scale as in Figure 11.6 for $n=1$ (see Figure 11.2.b).

- 3 Mark the characteristic point in the diagram where the characteristic point is the values of I_c and P_c give u_{\max} . Draw a vertical line marking the value of I_c and a horizontal line marking the value of P_c , see Figure 11.8.
- 4 Lay the transparent paper with the damage curve from Figure 11.6 on the diagram in Figure 11.7 where also the characteristic point (see point 3) is plotted. The asymptotes in Figure 11.6 shall coincide with the lines plotted in point 3.

- 5 The created damage curve is now representing all combinations of P_I and I , for a certain load-time curve and material, giving the maximum displacement u_{\max} for which I_c and P_c have been calculated. The diagonal lines give information about the time duration t_I .

11.4.2 Example

The same beam as used in the example in Section 11.3.2 is used here but here the values of P_I and I shall be estimated by use of damage curves. The maximum allowed displacement u_{\max} corresponds to $u_{\max}(P_c) = u_{\max}(I_c)$ calculated in example in Section 11.3.2. Also here linear elastic material is assumed:

$$u_{\max} = 2.79 \text{ mm}, M_e = \kappa_{MP}^{el} M = 0.762 \cdot 2100 = 1600 \text{ kg}, \omega_e = \sqrt{\frac{\kappa_{KP}^{el} K}{\kappa_{MP}^{el} M}} = 1456 \text{ rad/s},$$

$$t_1 = \frac{2I}{P_1} = 1.12 \text{ ms}$$

Search for the values of the maximum value of the load P_I and the impulse I resulting in the maximum allowed displacement u_{\max} .

The load is assumed to be triangular in time (as shown in Figure 11.2.b).

$$P(t) = P_1 \left(1 - \frac{t}{t_1} \right)$$

The characteristic values of the impulse and pressure load, I_c and P_c , is calculated by use of Equation c) and d) in Table 9.1:

$$u_{\max}(P_c) = \frac{2P_c}{\kappa_{KP}^{el} K} = \frac{2P_c}{\omega_e^2 \kappa_{MP}^{el} M} \Leftrightarrow P_c = \frac{u_{\max} \omega_e^2 \kappa_{MP}^{el} M}{2} = \frac{2.79 \cdot 10^{-3} \cdot 1456^2 \cdot 1600}{2} =$$

$$= 4732 \text{ kN}$$

$$u_{\max}(I_c) = \frac{1}{\sqrt{\kappa_{KP}^{el} \kappa_{MP}^{el}}} \frac{I_c}{\sqrt{KM}} = \frac{I_c}{\omega_e \kappa_{MP}^{el} M} \Leftrightarrow$$

$$I_c = u_{\max} \cdot \omega_e \cdot \kappa_{MP}^{el} M = 2.79 \cdot 10^{-3} \cdot 1456 \cdot 1600 = 6500 \text{ Ns}$$

By following point 1 to 5 above the damage curve of interest is created and the values of the impulse and maximum pressure load can be determined, see Figure 11.8.

$$I = 7000 \text{ Ns} \quad \text{and} \quad P_1 = 12500 \text{ kN}$$

If the maximum allowed displacement for a SDOF system u_{\max} is 2.79 mm and the mass and circular frequency is 1600 kg and 1456 rad/s respectively the maximum value of the pressure load (which is triangular in time) is $P_I = 12500 \text{ kN}$. The maximum allowed impulse is $I = 7000 \text{ Ns}$ if the time duration of the load t_I is 1.12 ms.

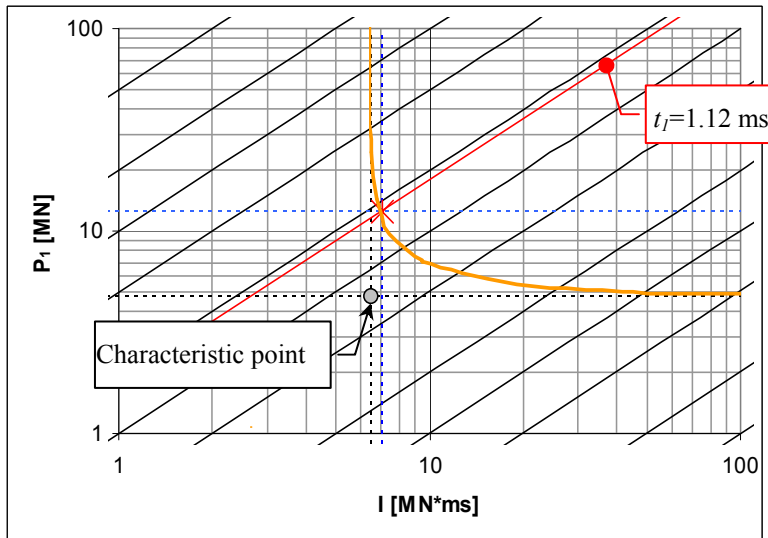

Figure 11.8 Diagram for damage curve for example 1.

If the duration of the load t_l instead was 5 ms the values of P_l 5850 kN is and I is 14500 Ns, see Figure 11.9.

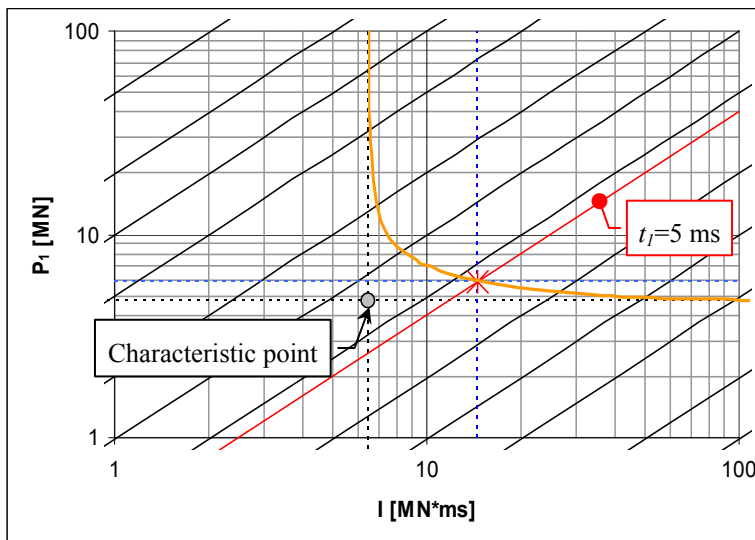

Figure 11.9 Diagram for damage curve for example 1, if $t_l = 5$ ms.

12 Concrete

Principal relations between the load and deflection of a simply supported, reinforced concrete beam for different loading cases are shown in Figure 12.1 where the loads are applied by gradual stages.

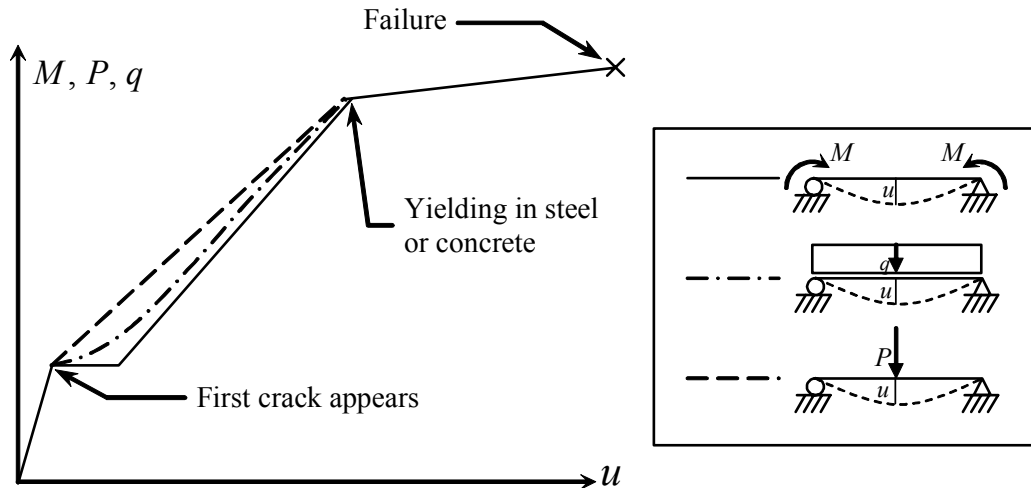

Figure 12.1 Principal relations between load and deflection of a simply supported beam subjected to different loads based on Svensk byggtjänst (1990).

At first the beam is uncracked and the bending stiffness of the beam is high. The deflection of the beam increases linearly with the load, the beam is in stadium I. When the load has reached a value that gives stresses in the most tensioned section that is equal to the flexural strength of the concrete the section will crack. Due to the crack the change of stiffness is sharp, now the reinforcement in the tensioned zone carries the tensional forces. For increasing load more and more cross-sections will crack, but this will not influence the behaviour of the beam very much and the deflections increases almost linearly with the increasing load, the beam is in stadium II. Reinforced beams are normally designed to get yielding in the reinforcement before the ultimate compressive strain is reached. When the reinforcement starts to yield the beam gets a plastic behaviour and the deflection increases even though the load is almost constant, the beam is in stadium III. At last the beam can not endure the load and there will be flexural failure.

An idealization of the load-displacement relation is shown in Figure 12.2 where P_{cr} is the load for which the first crack occurs and u_{cr} is the corresponding deflection. P_{pl} is the ultimate load and u_{pl} is the corresponding deflection. K is the stiffness of the uncracked beam and K' is the inclination of the load-displacement curve after the first crack occurs. In the following analyses of reinforced beams it is assumed that the steel starts to yield before the concrete and the load for which yielding starts in the steel is P_{spl} and u_{spl} is the corresponding deflection. This idealized behaviour of a reinforced concrete beam will be used in this report and the idealized relation between the load

and deflection can be found by using crack and failure criteria as shown in Section 12.2.

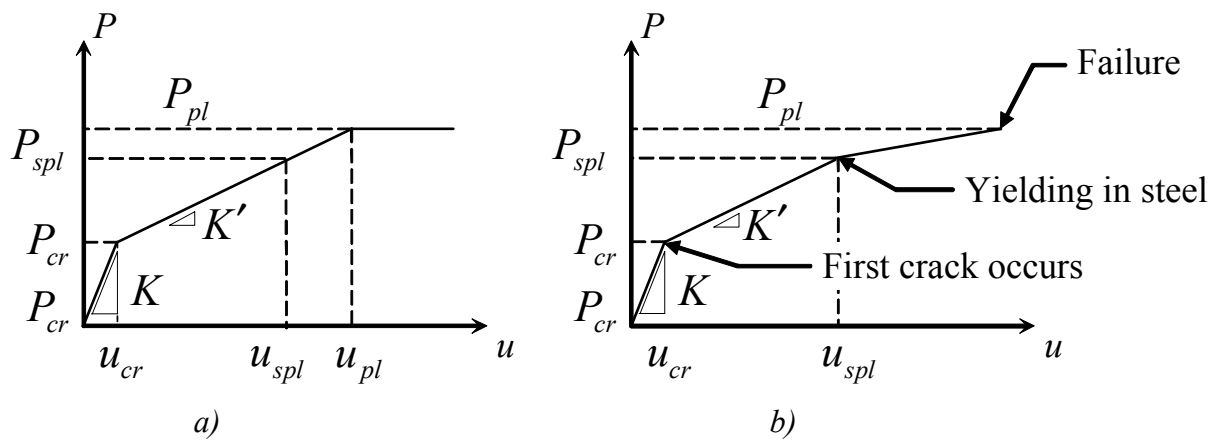

Figure 12.2 a) Idealized load-displacement curve used in this report b) idealized principal load-displacement curve for reinforced concrete beam, based on Figure 12.1.

12.1 Material behaviour

A structure subjected to a dynamic load behaves different from a structure subjected to a static load especially when the load is an intensive impulse load with short duration.

The strain velocity $\dot{\epsilon}$, defined as the strain per time unit, describes how fast the material deforms and is defined as:

$$\dot{\epsilon} = \frac{\epsilon}{\Delta t} \tag{12.1}$$

The faster the load is applied to the structure the higher strain velocity is attained in the concrete. In Figure 12.3 strain velocities for some different load situations are shown.

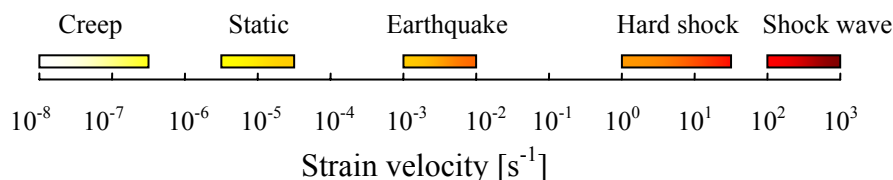

Figure 12.3 Strain velocity for common load situations. From Räddningsverket (2004).

By experimental tests it has been found that if the strain velocity is higher than 10 s^{-1} the dynamic magnification factor, defined as the relation between the dynamic and the static strength, can be more than doubled if the concrete is compressed and magnified by up to seven if the concrete is tensioned, Råddningsverket (2004). The relation between the strain velocity and the dynamic magnification factor are shown in Figure 12.4 and Figure 12.5 for compressed and tensioned concrete respectively.

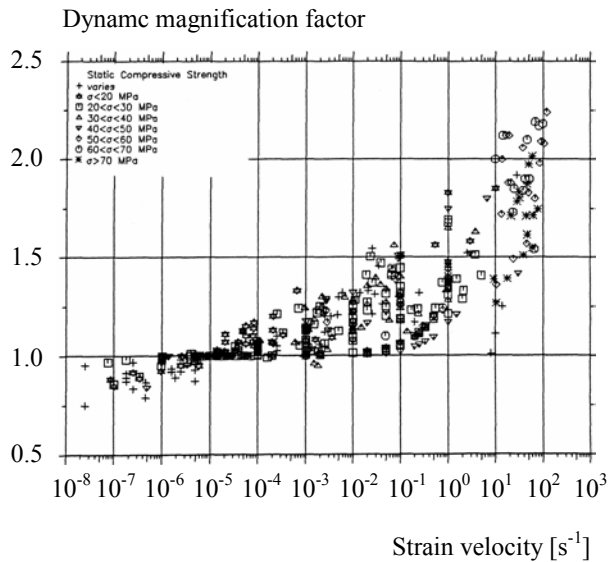

Figure 12.4 Relation between dynamic magnification factor and strain velocity for compressed concrete, experimental results. From Råddningsverket (2004).

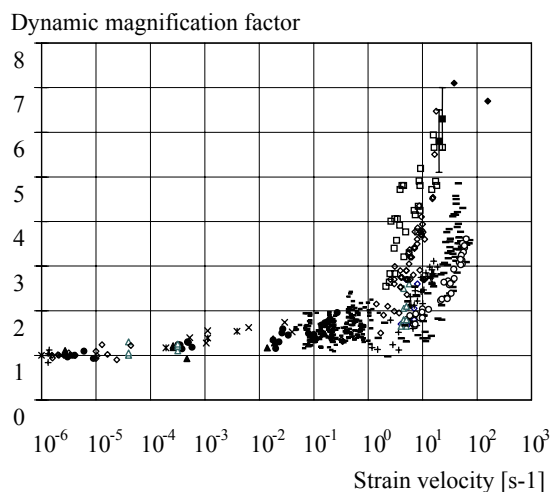

Figure 12.5 Relation between dynamic magnification factor and strain velocity for tensioned concrete, experimental results. From Råddningsverket (2004).

The increased strength for concrete structures subjected to dynamic loads, discussed above, can partly be explained by the crack way trough the material. When a concrete specimen is subjected to a static tensional force the cracks will find the most energy effective way through the concrete. Since the ballast often is stronger than the paste in concrete the most energy effective way is to go in the paste around the ballast, see Figure 12.6. In case of dynamic loading there is no time for this and the cracks are very often forced to go also through the ballast, which gives a higher tensile strength of the concrete. Even though each individual crack will be more brittle in case of dynamic loading more cracks will appear and the overall ability to take up energy may increase somewhat. The increased strength of the concrete can also be explained by viscose effects.

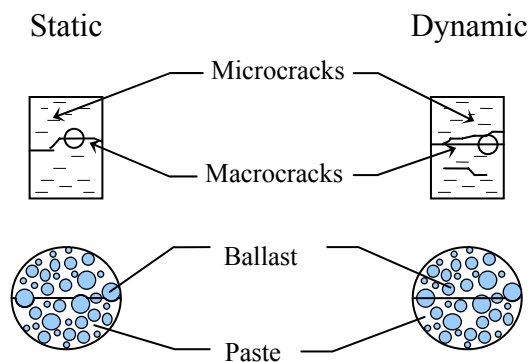

Figure 12.6 Principle crack way for static and dynamic load respectively. Based on Räddningsverket (2004).

A concrete beam subjected to a dynamic load behaves differently from the static load case, especially initially. For a very fast load application there can be local failures in some sections of the beam before other parts even are aware of the load (principle illustrated in Figure 12.7). This phenomenon can be explained by the time required to spread the information of the external load in the material. For concrete the longitudinal wave velocity is approximately 3500 m/s and for a 2.5 meter long beam subjected to a concentrated load, applied at the midpoint, it will take $1.25/3500 \approx 0.36$ ms until the information has reached the supports.

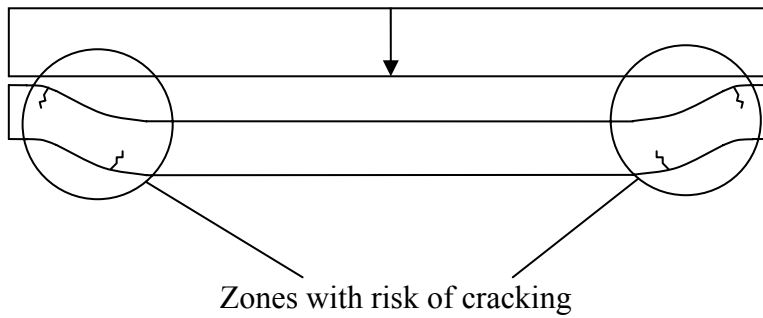

Figure 12.7 Principle initial behaviour of beam subjected to a dynamic concentrated load.

When using equivalent static loads this initial behaviour is not taken into account even though the use of equivalent static load gives a well estimated value of the maximum displacement.

12.2 Analysis of cross-sections subjected to bending

Due to the complexity of the behaviour of a reinforced concrete beam the analysis is made in different stages depending on if cracks have occurred or not. Analyses of cross-sections in stadium I and II are in case of static load often calculated in service limit state but since all calculations when designing shelters shall be made in ultimate limit state (Räddningsverket (2003)) only this case are treated here. Also analyses of cross-sections in stadium III are made in ultimate limit state. By following Engström (2001) the expressions useful in the analysis are stated for stadium I, II and III respectively.

In ultimate limit state safety factors are used when calculating the design values of the material properties.

$$f_d = \frac{f_k}{\eta\gamma_m\gamma_n} \quad (12.2)$$

$$E_d = \frac{E_k}{\eta\gamma_m\gamma_n} \quad (12.3)$$

In the Swedish shelter regulation the design value of the tensile stress for the steel is:

$$f_{st} = 0.9f_{yk} \quad (12.4)$$

The partial safety factor γ_n (in Equations (12.2) and (12.3)) taking the safety class into consideration is equal to 1.0 in case of accidental load, no matter which safety class it is. The product of the safety factor γ_m (in Equations (12.2) and (12.3)) taking the

insecurity when determining the material parameters and η are, for accidental load, shown in Table 12.1.

Table 12.1 Partial safety factors for concrete and reinforcing steel for accidental load.

Material		$\eta\gamma_m$
Concrete	Strength parameters	1.2
	Modulus of elasticity	1.0
Reinforcing steel	Strength parameters	1.0
	Modulus of elasticity	1.0

Due to the fact that the compressive strength of concrete increases the faster the load is applied the design value of the compressive strength can be increased when the load is an accidental load with dynamic behaviour.

$$f_{ccd}^{accidental} = 1.1f_{ccd} \quad (12.5)$$

In case of dynamic load a higher value of the modulus of elasticity for the concrete is used, according to the Swedish design code BBK 04, Boverket (2004):

$$E_{cd}^{dynamic} = \frac{1.2 \cdot E_{ck}}{\eta\gamma_m\gamma_n} \quad (12.6)$$

12.2.1 Calculations in stadium I and II

Stadium I is earlier defined as the stadium when the cross-section is uncracked and stadium II is defined as the stadium when the cross-section is cracked but there is still no yielding of the material. In stadium I and II the beam has elastic behaviour.

12.2.1.1 Strain distribution for the cross-section

The deformation of the cross-section is described by the strain distribution which is characterized by a mean strain ε_{cm} and a curvature $1/r$, see Figure 12.8. The mean strain represents the strain in the centre of gravity of the cross-section meaning the centre of gravity of the transformed cross-section calculated with respect to stiffness. The meaning of a transformed cross-section is further explained in Section 12.2.1.3. The curvature is represented by the strain gradient meaning the inclination of the strain curve.

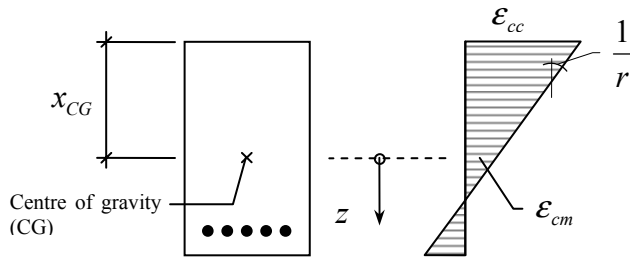

Figure 12.8 The deformation of the cross-section is described by the strain distribution based on Engström (2001).

At a distance z from the centre of gravity the strain can be seen as a result of the mean strain plus a strain depending on the curvature as:

$$\epsilon_c(z) = \epsilon_{cm} + \frac{1}{r}z \quad (12.7)$$

The curvature is expressed by using the radius of curvature r . The curvature can be seen as the change of angle per unit length and can for a beam element with constant value of the curvature be expressed as:

$$\frac{1}{r} = \frac{d\phi}{dx} \quad (12.8)$$

where $d\phi$ is the change of angle over the element length dx . The meanings of the notations are also seen in Figure 12.9.

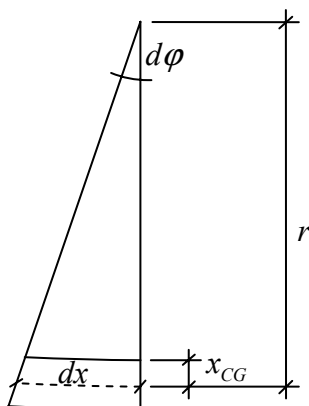

Figure 12.9 Relation between the radius of curvature and flexural deformation for a beam element with constant curvature based on Engström (2001).

The neutral layer is defined as the layer in the cross-section where the strain and the stress is zero. In case of pure bending the neutral layer coincides with the centre of

gravity meaning that the mean strain ε_{cm} is zero and the strain at a distance z from the centre of gravity is:

$$\varepsilon_c(z) = \frac{1}{r}z \quad (12.9)$$

12.2.1.2 Assumptions

The analysis methods described in this chapter are used to calculate normal stresses in cross-sections subjected to pure bending (no axial forces are present). The strain distribution is assumed to be linearly over the height of the cross-section and full interaction is assumed between the steel and the concrete. The meaning of the full interaction between the steel and the concrete is illustrated in Figure 12.10 where the concrete strain ε_c equals the steel strain ε_s at the level of the reinforcement.

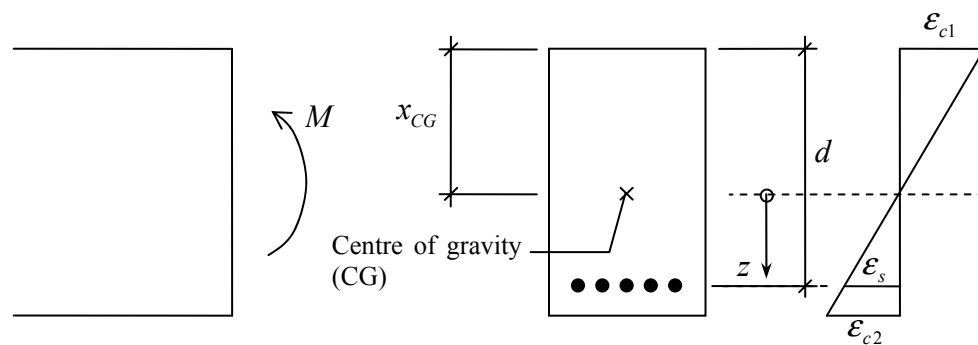

Figure 12.10 Strain distribution in uncracked rectangular cross-section of reinforced concrete subjected to pure bending.

ε_{c1} and ε_{c2} are the concrete strain in the compressed and tensioned edges respectively and x_{CG} is the distance from the compressed edge to the centre of gravity calculated with respect to stiffness. The cross-section is subjected to a moment M .

In stadium II, when the beam is cracked due to bending, the influence of the concrete in tension underneath the neutral layer is neglected even though the tensioned concrete in between the cracks influences the load carrying capacity of the beam. The influence from the tensioned concrete is largest directly after the appearance of the first crack and decreases when the load increases, see Figure 12.11.

Yielding are here assumed to always start in the steel meaning that the steel in the tensile zone is assumed to reach the yield stress before the concrete strain in the compressed edge reaches the ultimate concrete strain.

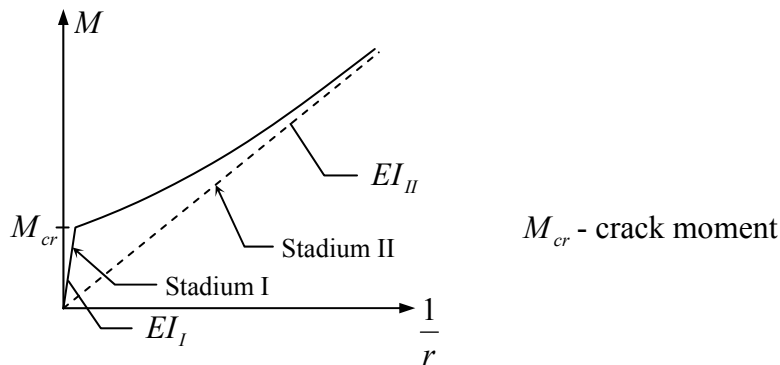

Figure 12.11 Principal relation between the moment and mean curvature for zone with flexural cracks. Influence from tensioned concrete between the cracks result in a relation that smoothly approach the stadium II stiffness.

Since stadium I or II is assumed elastic response is assumed for both concrete and reinforcement steel.

$$\sigma_c = E_c \varepsilon_c \quad (12.10)$$

$$\sigma_s = E_s \varepsilon_s \quad (12.11)$$

where σ_c normal stress in concrete

E_c modulus of elasticity for concrete

ε_c concrete strain

σ_s normal stress in steel

E_s modulus of elasticity for steel

ε_s steel strain

All analyses and calculation method used in this chapter neglects long time influences such as shrinkage and creep deformations.

12.2.1.3 Transformed cross-section

In order to facilitate the calculations the steel and concrete cross-section can be replaced with an equivalent concrete cross-section, also called a transformed cross-section, without influencing the results. The expressions for the area of the transformed cross-section, for a double reinforced concrete beam, in stadium I is:

$$A_I = A_c + (\alpha - 1)A_s' + (\alpha - 1)A_s \quad (12.12)$$

where A_c whole area of the concrete (without reduction for the reinforcement area)

A_s' area of compressed reinforcement

A_s area of tensioned reinforcement

The factor α is the relation between the modulus of elasticity for steel and concrete and is defined as:

$$\alpha = \frac{E_s}{E_c} \quad (12.13)$$

For cracked cross-sections (stadium II) the transformed cross-section is (using the same notations as in Equation (12.12)):

$$A_{II} = A_{cc} + (\alpha - 1)A_s' + \alpha A_s \quad (12.14)$$

where A_{cc} is the area of the compressed zone (without reduction for the reinforcement area).

12.2.1.4 Crack criteria

Due to the crack criterion for a beam subjected to pure bending the cross-section will remain uncracked as long as the maximum value of the tensional stress fulfils:

$$\sigma_{ct,max} < \frac{f_{cbt}}{\zeta} \quad (12.15)$$

ζ is the crack security factor chosen to be 1.0 in order to assume a realistic crack pattern and f_{cbt} is the flexural strength calculated as:

$$f_{cbt} = k \cdot f_{ct} \quad (12.16)$$

$$k = 0.6 + \frac{0.4}{\sqrt[4]{h}} \quad \text{and} \quad 1.0 \leq k \leq 1.45$$

where h is the total height of the beam and f_{ct} is the concrete tensile strength.

This means that the cross-section will crack when the maximum value of the tensile stress is:

$$\sigma_{ct,max} = \frac{f_{ct}}{\zeta} \quad (12.17)$$

In Navier's formula the concrete stresses in the cross-section can be calculated by using the moment M in the cross-section together with the equivalent value of the moment of inertia, I_I and I_{II} respectively and the distance from the neutral layer. With z defined as shown in Figure 12.8 the stress in the concrete for an uncracked cross-section is calculated as:

$$\sigma_c(z) = \frac{M}{I_I} z \quad (12.18)$$

In case of a cracked cross-section the concrete stress at distance z from the neutral layer is calculated as:

$$\sigma_c(z) = \frac{M}{I_{II}} z \quad (12.19)$$

12.2.1.5 Reinforced cross-section in stadium I

Studying the uncracked single symmetric cross-section in Figure 12.10 subjected to pure bending. The tensioned reinforcement, with total area A_s , is placed in the tensioned zone at the distance z_s from the neutral layer and the compressed reinforcement, with a total area A_s' , is placed in the compressed zone.

$$z_s = d - x_{CG} \quad (12.20)$$

Here d is the effective height of the cross-section meaning the distance from the compressed edge to the layer of reinforcement. x_{CG} is the distance from the compressed edge to the centre of gravity calculated with respect to the stiffness (see Figure 12.10).

Due to the assumption of full interaction between the steel and the concrete the steel stress can be calculated as:

$$\sigma_s = \alpha \sigma_c(z_s) \quad (12.21)$$

where the concrete stress at the reinforcement layer $\sigma_c(z_s)$ is calculated as shown in Equation (12.18):

$$\sigma_c(z_s) = \frac{M}{I_I} z_s \quad (12.22)$$

where the moment of inertia in case of an uncracked cross-section is calculated as:

$$I_I = \frac{bh^3}{12} + (\alpha - 1)A_s' (x_{CG} - d')^2 + (\alpha - 1)A_s (d - x_{CG})^2 \quad (12.23)$$

12.2.1.6 Reinforced cross-section in stadium II

In stadium II the cross-section is assumed to be cracked and the influences from the concrete in tension is neglected (see Section 12.2.1.2). The stress distribution in the transformed cross-section is calculated by multiplying the concrete strain with the modulus of elasticity for concrete (see Equation (12.10)) why only the stresses in the concrete are shown in Figure 12.12. Underneath the neutral layer fictive concrete stresses are calculated and the steel stress is calculated from the fictive concrete stress at the steel level.

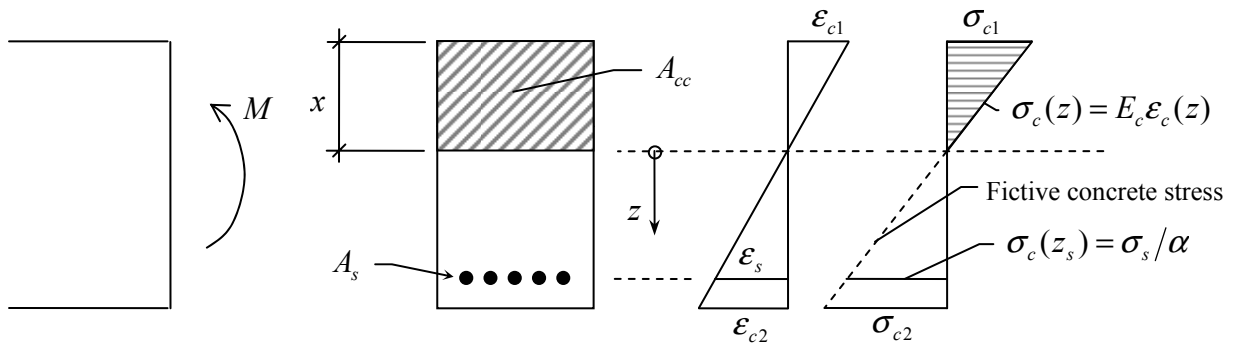

Figure 12.12 Strain and stress distribution in cracked rectangular cross-section of reinforced concrete subjected to pure bending.

The height x of the compressed concrete zone is calculated by using an equation of equilibrium. As mentioned in Section 12.2.1.1 the centre of gravity, calculated with respect to the stiffness, for the transformed cross-section coincides with the neutral layer meaning:

$$x = x_{CG} \quad (12.24)$$

The distance from the compressed edge to the centre of gravity for the transformed cross-section is calculated as (for a rectangular cross-section):

$$x_{CG} = \frac{bx \frac{x}{2} + (\alpha - 1)A_s' d'^2 + \alpha A_s d^2}{A_{II}} \quad (12.25)$$

Using Equations (12.14), (12.24) and (12.25) the equilibrium equation can be written as:

$$x(bx + (\alpha - 1)A_s' + \alpha A_s) = bx \frac{x}{2} + (\alpha - 1)A_s' d' + \alpha A_s d \quad (12.26)$$

Rearranging the terms in Equation (12.26) the equation from which x can be calculated is:

$$\frac{bx^2}{2} + (\alpha - 1)A_s'(x - d') + \alpha A_s(x - d) = 0 \quad (12.27)$$

or

$$x^2 + \frac{2}{b} \left((\alpha - 1)A_s' + \alpha A_s \right) x - \frac{2}{b} \left((\alpha - 1)A_s' d' + \alpha A_s d \right) = 0 \quad (12.28)$$

The moment of inertia in case of a cracked rectangular cross-section is calculated as:

$$I_{II} = \frac{bx^3}{12} + bx \left(\frac{x}{2} - x_{CG} \right)^2 + (\alpha - 1)A_s'(x - d')^2 + \alpha A_s(d - x)^2 \quad (12.29)$$

Using Equation (12.24) together with Equation (12.29) gives the expression for the moment of inertia in stadium II for a rectangular cross-section.

$$I_{II} = \frac{bx^3}{3} + (\alpha - 1)A_s'(x - d')^2 + \alpha A_s(d - x)^2 \quad (12.30)$$

The concrete stress at the steel level is:

$$\sigma_c(z_s) = \frac{M}{I_{II}} z_s \quad (12.31)$$

Due to the assumption of full interaction between the steel and the concrete and that yielding starts in the reinforcement the concrete stress at steel level can be calculated as:

$$\sigma_c(z_s) = \frac{\sigma_{sy}}{\alpha} \quad (12.32)$$

The moment M can now be calculated by using Equations (12.31) and (12.32).

$$\frac{M}{I_{II}} z_s = \frac{\sigma_{sy}}{\alpha} \Leftrightarrow M = \frac{\sigma_{sy} I_{II}}{\alpha z_s} \quad (12.33)$$

12.2.2 Calculations in stadium III

In this chapter calculation models are shown for flexural failure due to pure bending of reinforced concrete beams with rectangular cross-section. Only a method with simplified stress block is shown.

12.2.2.1 Failure criteria

In stadium III plastic behaviour of the materials are both possible and wanted. Yielding of the material gives a ductile behaviour and facilitates force redistribution in the structure.

The failure is determined by the deformation capacity of the materials. In the Swedish calculation code BBK 04, Boverket (2004), the failure criteria are:

For ordinary concrete (with characteristic compressive strength $f_{ck} \leq 60$ MPa):

- ultimate concrete strain is limited to

$$|\varepsilon_{cc}| \leq 3.5 \cdot 10^{-3} \quad (12.34)$$

For cold-worked reinforcing steel:

- The strain is limited to

$$\varepsilon_s \leq \varepsilon_g - 0.01 \quad (12.35)$$

where ε_g is the limit strain.

For hot-rolled reinforcing steel there is no limitation of the strain because the capacity of deformation is very high.

12.2.2.2 Reinforced rectangular cross-section in stadium III

For cross-section with flexural cracks and hot-rolled reinforcing steel subjected to pure bending the determining failure criteria is always limited by Equation (12.34), i.e. This means that the concrete strain in the compressed edge ε_{cc} has reached the maximum value ε_{cu} .

$$\varepsilon_{cc} = \varepsilon_{cu} = 3.5 \cdot 10^{-3} \quad (12.36)$$

When the maximum value of the concrete strain in the compressed edge is reached the cross-section is about to fail and the cross-section has reached the ultimate limit for which the bearing capacity shall be calculated.

The same cross-section used in Section 12.2.1.5 and 12.2.1.6 shall be studied but in stadium III. As in stadium II a compressive zone is formed but in here the stress distribution is no longer linear because of the yielding, see Figure 12.13.

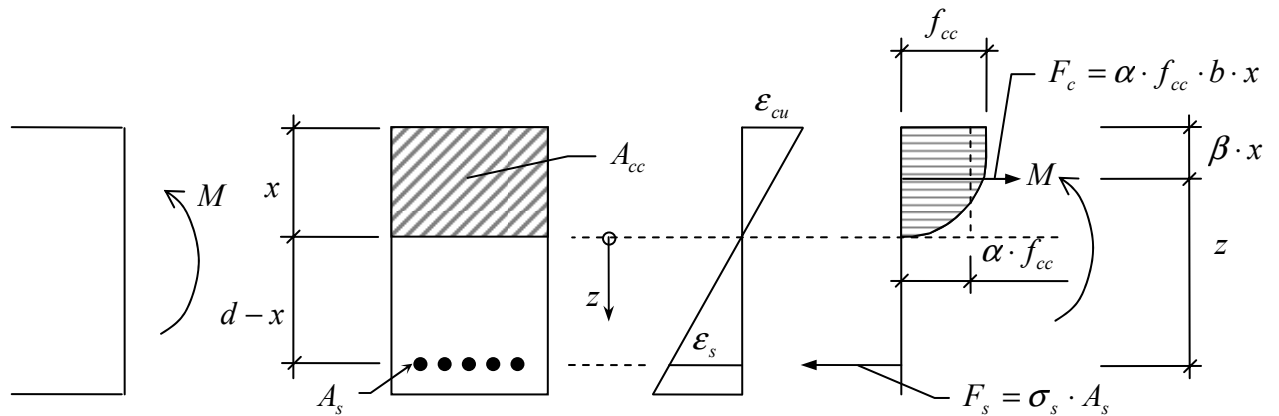

Figure 12.13 Strain and stress distribution in cracked rectangular cross-section of reinforced concrete subjected to pure bending where the maximum value of the concrete strain in the compressed edge is reached

In case of a simplified rectangular stress block the values of α and β are 0.8 and 0.4 respectively.

The assumption of linear strain distribution means that the steel strain is equal to the concrete strain at the reinforcement layer and the steel strain can be expressed as:

$$\epsilon_s = \frac{d-x}{x} \epsilon_{cu} \quad (12.37)$$

and as in stadium II the influence of the tensioned concrete is neglected.

The compressive resultant F_c , placed at the distance $\beta x = 0.4x$ from the compressed edge, can be calculated as:

$$F_c = f_{cc} \cdot b \cdot \alpha x = f_{cc} \cdot b \cdot 0.8x \quad (12.38)$$

The internal lever arm is:

$$z = d - \beta x = d - 0.4x \quad (12.39)$$

Equilibrium equations for the rectangular cross-section can be expressed as:

$$f_{cc} \cdot b \cdot 0.8x = \sigma_s \cdot A_s \quad (12.40)$$

$$M_{pl} = f_{cc} \cdot b \cdot 0.8x(d - 0.4x) \quad (12.41)$$

where M_{pl} is the ultimate moment capacity.

12.2.2.3 Rotational capacity

The yielding capacity in case of bending, called the rotational capacity, is the largest change of angle that a plastic hinge can undergo and still keep its maximum moment capacity. Calculations of the rotational capacity are here made by following Svensk byggtjänst (1990).

According to Svensk byggtjänst (1990) the rotational capacity, expressed in radians, can be calculated as:

$$\theta_{pl} = A \cdot B \cdot C \cdot 10^{-3} \quad (12.42)$$

where the factors A , B and C depends on the reinforcement arrangement, the strain-stress relation for reinforcing steel and the position of the plastic hinge respectively.

The factor A (where $A \geq 0.05$ must be fulfilled) is calculated as:

$$A = 1 + 0.6\omega_v + 1.7\omega'_s - 1.4 \frac{\omega_s}{\omega_{bal}} \quad (12.43)$$

where

$$\omega_v = \frac{A_{sv} \cdot f_{sv}}{b_c \cdot s \cdot f_{ct}} \quad (12.44)$$

A_{sv} total area of the shear reinforcement

f_{sv} shear strength of reinforcing steel

b_c width of the compressed block

s spacing of shear reinforcement in between the plastic hinge and where the moment is zero

f_{ct} tensional strength of the concrete

$$\omega'_s = \frac{A'_s \cdot f_{sc}}{b_c \cdot d \cdot f_{cc}} \quad (12.45)$$

A'_s total area of the reinforcement in compressed block

f_{sc} compressive strength of reinforcing steel

d effective height

f_{cc} compressive strength of the concrete

$$\omega_s = \frac{A_s \cdot f_{st}}{b_c \cdot d \cdot f_{cc}} \quad (12.46)$$

A_s total area of tensioned reinforcement

f_{st} tensile strength of reinforcing steel

$$\omega_{bal} = 0.8 \frac{3.5 \cdot 10^{-3}}{3.5 \cdot 10^{-3} + f_{st}/E_s} \quad (12.47)$$

E_s modulus of elasticity for reinforcing steel

However, there are some limitations for the expressions in Equations (12.44), (12.45) and (12.46).

$$\omega_v \leq 2.0 \text{ if } s \leq 0.8 \cdot b_c \text{ otherwise } \omega_v = 0 \quad (12.48)$$

$$\omega'_s \leq \omega_s \text{ provided that } s \leq 15 \cdot \min(\phi'_s) \text{ otherwise } \omega'_s = 0 \quad (12.49)$$

where ϕ'_s is the diameter of the reinforcement bars subjected to compression.

$$\omega_s \leq \omega_{bal} \quad (12.50)$$

The factor B is equal to 1.0 for hot rolled, not weldable, reinforcement bars and 0.8 for hot rolled, weldable, reinforcement bars. For further information about the factor B and its values see Svensk byggtjänst (1990).

In field the value of factor C is:

$$C = 7 \cdot l_0 / d \quad (12.51)$$

and by supports the value is:

$$C = 10 \cdot l_0 / d \quad (12.52)$$

where l_0 is the distance from the plastic hinge to the place where the moment is zero.

The calculations of required rotational capacity are made by the principle that if the plastic hinges have to rotate in order to form the assumed failure mechanism. In each plastic hinge the moment is known (it is the yielding moment) and the structure is then statically determinable and the required rotation can be calculated.

The mechanism for a fixed beam is shown in Figure 12.14 below where $\theta_{support}$ and θ_{field} is the total rotations in the plastic hinges at the support and midpoint respectively.

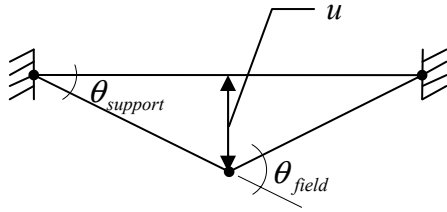

Figure 12.14 Mechanism and rotations.

Due to symmetry the total rotation at the supports is equal and the total rotation at the plastic hinge in the middle of the beam is twice the size of the support rotation.

$$\theta_{field} = 2\theta_{support} \quad (12.53)$$

where the total rotation at the supports in case of a fixed beam is:

$$\theta_{support} = \frac{2u}{L} \quad (12.54)$$

The total rotation can be divided into a plastic and an elastic part as shown in Figure 12.15.

$$\theta_{support} = \theta_{el,support} + \theta_{pl,support} \quad (12.55)$$

$$\theta_{field} = \theta_{el,field} + \theta_{pl,field} \quad (12.56)$$

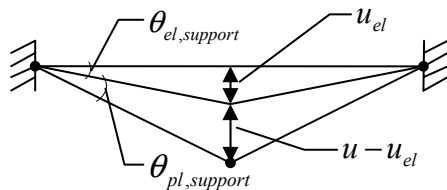

Figure 12.15 Elastic and plastic rotations of fixed beam (compare with Figure 12.14).

By means of elementary cases in Samuelsson, Wiberg (1999) the value of the elastic part of the rotation can be calculated. For a fixed beam subjected to a uniformly distributed load q the midpoint deflection, in case of static load and linear elastic behaviour, is:

$$u_{el} = \frac{qL^4}{384EI} \quad (12.57)$$

The maximum value of q for which Equation (12.57) is valid is calculated by use of the maximum elastic moment at the support, where yielding starts:

$$M_{el} = \frac{qL^2}{12} \Rightarrow q = \frac{12M_{el}}{L^2} \quad (12.58)$$

and Equation (12.58) can be written as:

$$u_{el} = \frac{12M_{el}L^2}{384EI} = \frac{M_{el}L^2}{32EI} \quad (12.59)$$

The corresponding rotational capacity at the support can be calculated as:

$$\theta_{el,support} = \frac{2u_{el}}{L} \quad (12.60)$$

which is easily seen in Figure 12.15.

Due to symmetry the elastic rotation capacity at the supports is equal and the elastic rotation capacity in the middle of the beam is twice the size of the support rotation.

$$\theta_{el,field} = 2\theta_{el,support} = \frac{4u_{el}}{L} \quad (12.61)$$

The plastic support rotation can now be calculated as:

$$\theta_{pl,support} = \theta_{support} - \theta_{el,support} = \frac{2u}{L} - \frac{2u_{el}}{L} = \frac{2u}{L} - \frac{M_{el}L}{16EI} \quad (12.62)$$

and the plastic field rotation is:

$$\theta_{pl,field} = \theta_{field} - \theta_{el,field} = \frac{4u}{L} - \frac{4u_{el}}{L} = \frac{4u}{L} - \frac{M_{el}L}{8EI} \quad (12.63)$$

12.3 Requirements of structural parts and materials in shelters due to Swedish shelter regulations

In order to fulfil demands on functionality and durability of a shelter some minimum requirements on design and material are presented in the Swedish shelter regulation where the shelter is assumed to be built of reinforced concrete. Here only a brief review of the requirements is done, for further information see R ddningsverket (2003). The characteristic values of the loads shall be used in the analyses and safety coefficients for accidental loads shall be used.

Minimum requirements for thicknesses of structural elements in a shelter due to the Swedish shelter regulation are shown in Table 12.2. The values in Table 12.2 are valid for structures assumed to have no significant protection from other buildings and are based on thicknesses required to protection from splinter and radioactive radiation.

Table 12.2 Minimum thickness of structural members in shelters

Structural part	Minimum thickness [mm]
Roof	350
Floor	200
Wall (outer)	350

The concrete used in the shelter shall have at least strength class C25/30 and the amount of reinforcement is limited to:

$$0.14\% \leq \rho \leq 1.1\% \quad \text{where} \quad \rho = \frac{A_s}{b \cdot d} \quad (12.64)$$

The reinforcement shall be placed in two perpendicular layers with maximum 200 mm spacing between the parallel bars. No shortening of the reinforcement in fields is allowed and the maximum thickness of concrete cover is 50 mm. Reinforcement shall be placed both in tensile and compression zone.

Due to the Swedish shelter regulations a shelters shall endure an impulse load caused by a bomb containing 125 kg of the explosive substance TNT (trotyl) exploding 5 meters from the wall. This impulse load is assumed to, at the most, correspond to the equivalent static load $q=50 \text{ kN/m}^2$ which is applied as shown in Figure 12.16.

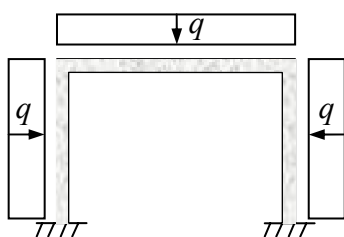

Figure 12.16 Load application due to Swedish shelter regulation where $q=50 \text{ kN/m}^2$.

The support moment M_s shall not be more than 50 per cent higher than the moment in the field M_f in order to get a ductile behaviour of the structure, i.e.:

$$M_s \leq 1.5M_f \quad (12.65)$$

12.4 Example; minimum amount of reinforcement

A wall in a shelter will be analysed. The design and geometry of the wall is chosen to fulfil the minimum requirements in Section 12.3. The measurements of the wall and the load applied are shown in Figure 12.17 below.

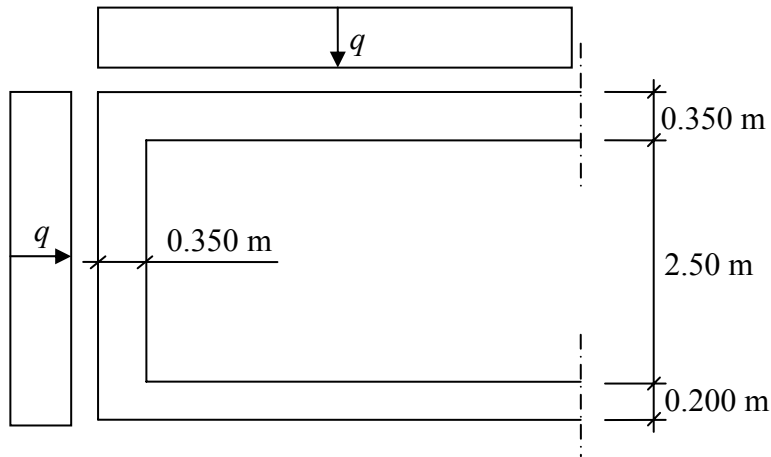

Figure 12.17 Shelter wall subjected to a uniformly distributed load q .

The wall in the shelter can be seen as a fixed beam with length 2.50 m subjected to a uniformly distributed load q as shown in Figure 12.18. Influences from the normal force in the wall, caused by the uniformly distributed load subjected to the shelter roof are neglected, giving calculations on the safe side.

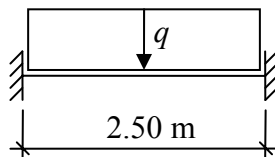

Figure 12.18 Idealization of shelter wall.

Studying a 1.0 meter wide strip of the beam gives a cross-section as shown in Figure 12.19.

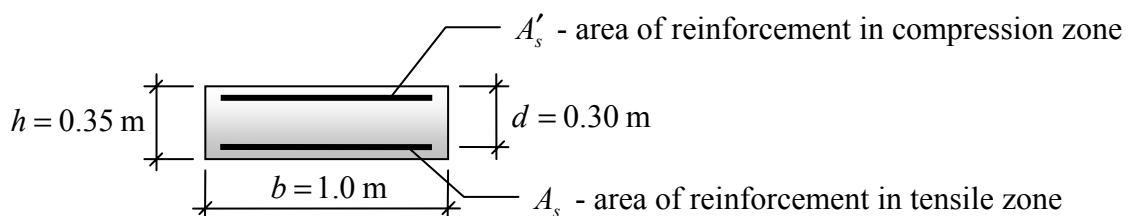

Figure 12.19 Cross-section of idealized beam in Figure 12.18.

Concrete C25/30 and reinforcement bars B500B are used and calculations are made in order to get the load-displacement curve for the beam, shown in Appendix I.

The stiffness K (see Figure 12.2) of the uncracked beam is:

$$K = 3332 \text{ MN/m} \quad (12.66)$$

The inclination of the load-displacement curve after the first crack has occurred, K' (see Figure 12.2) is:

$$K' = 102.7 \text{ MN/m} \quad (12.67)$$

The maximum value of the internal force R_m is:

$$R_m = q_{pl} \cdot L = P_{pl} = 502.4 \text{ kN} \quad (12.68)$$

By means of empirical relations in R adningsverket (2004) the corresponding impulse load to the equivalent static load q can be determined. Here q corresponds to an impulse load where the maximum value of the load P_I is approximately 5000 kN/m^2 and the impulse is about 2800 Ns/m^2 . If the load is assumed to be a triangular load (in time) as shown in Figure 12.20 the duration of the load can be calculated by means of Equation (12.69).

$$I = \int_{t=0}^{t=t_1} P(t) dt = \frac{P_1 \cdot t_1}{2} \Leftrightarrow t_1 = \frac{2I}{P_1} = \frac{2 \cdot 2800}{5000 \cdot 10^3} = 1.12 \text{ m} \quad (12.69)$$

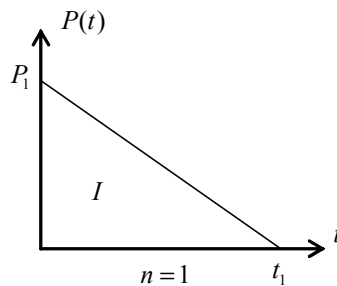

Figure 12.20 Triangular load (in time)

The value of the maximum deflection of the beam subjected to a dynamic load is calculated by means of transforming the beam into an SDOF system as described in Chapter 7. The equivalent values of the load, internal force and the mass is for the studied beam:

$$M_e = \kappa_M M \quad (12.70)$$

$$R_e = \kappa_K R$$

$$P_e = \kappa_p P$$

In case of trilinear material the differential equations in the different ranges are:

$$\begin{aligned} &\text{In the elastic range} \\ M_e \ddot{u} + K_e u &= P_e \end{aligned} \quad (12.71)$$

$$\begin{aligned} &\text{In the elastoplastic range} \\ M_e \ddot{u} + K_e u_{cr} + K'_e (u - u_{cr}) &= P_e \end{aligned} \quad (12.72)$$

$$\begin{aligned} &\text{In the plastic range} \\ M_e \ddot{u} + R_{me} &= P_e \end{aligned} \quad (12.73)$$

The transformation factors for linear elastic material is used in all ranges and Equations (12.71), (12.72) and (12.73) can now be written as:

$$\begin{aligned} &\text{In the elastic range} \\ \kappa_M^{el} M \ddot{u} + \kappa_K^{el} K u &= \kappa_P^{el} P \end{aligned} \quad (12.74)$$

$$\begin{aligned} &\text{In the elastoplastic range} \\ \kappa_M^{el} M \ddot{u} + \kappa_K^{el} (K u_{cr} + K' (u - u_{cr})) &= \kappa_P^{el} P \end{aligned} \quad (12.75)$$

$$\begin{aligned} &\text{In the plastic range} \\ \kappa_M^{el} M \ddot{u} + \kappa_K^{el} R_m &= \kappa_P^{el} P \end{aligned} \quad (12.76)$$

The transformation factors for linear elastic material are listed in Table 6.1:

The maximum displacement, u_{\max} , for the SDOF system, with equivalent quantities for mass, internal force and external load, is calculated by means of the central difference method (see Section 5.2) and by use of an in OCTAVE program, developed for this project, see Section 7.1.1.

$$u_{\max} = 31.1 \text{ mm} \quad (12.77)$$

If instead the transformation factors for ideal plastic material are used in Equations (12.74) to (12.76) the maximum displacement found by SDOF analysis is:

$$u_{\max} = 35.2 \text{ mm} \quad (12.78)$$

The maximum deflection when using transformation factors for linear elastic material in the SDOF analysis is smaller than the deflection achieved when using transformation factors for ideal plastic material in the analysis. This is expected since when using linear elastic values the mass becomes larger than when using the ideal plastic values since $\kappa_M^{el} > \kappa_M^{pl}$, meaning that less energy is consumed when starting up the system with ideal plastic values, see discussion in Section 8.1.

Available rotational capacity, in support and field respectively, for the beam is, see Appendix I:

$$\theta_{d,pl,support} = 0.0092 \text{ rad} \quad (12.79)$$

$$\theta_{d,pl,field} = 0.0155 \text{ rad} \quad (12.80)$$

The required rotational rotation capacity, in support and field respectively, for the beam is, see Appendix I:

$$\theta_{pl,support} = 0.0235 \text{ rad} \quad (12.81)$$

$$\theta_{pl,field} = 0.0470 \text{ rad} \quad (12.82)$$

The required rotational capacity is much higher than the available rotational capacity (compare Equations (12.79) and (12.80) with Equations (12.81) and (12.82)) meaning that the wall in the shelter, see Figure 12.18, subjected to the transient load, in Figure 12.20, will not endure the load and will collapse.

The equivalent load used in the Swedish shelter regulations, Räddningsverket (2003) is based on a load with long duration since this load is the one assumed to be most unfavourable. However, the results above indicate that this might not be true. On the other hand, the calculation method used when estimating the rotational capacities in Svensk byggtjänst (1990) might be too conservative. When the equivalent load used in the Swedish shelter regulations were determined the way of calculating the rotational capacity used in Svensk byggtjänst (1990) were not known, or at least not well-known.

Now also consider linear elastic and ideal plastic material behaviour. In the linear elastic case the stiffness K is assumed to be the same as the stiffness K for the trilinear material (see Equation (12.66)). For ideal plastic material the maximum value of the internal force R_m is the same as in case of trilinear material, see Equation (12.68).

12.4.1 Linear elastic behaviour

In case of linear elastic material the differential equation is:

$$M_e \ddot{u} + R_e = P_e \quad (12.83)$$

For linear elastic material the internal force is:

$$R = K \cdot u \quad (12.84)$$

where the stiffness K is assumed to be the same as in the trilinear case:

$$K = 3332 \text{ MN/m} \quad (12.85)$$

Inserting Equations (12.70) and (12.84) into Equation (12.83) the differential equation is:

$$\kappa_M M\ddot{u} + \kappa_K Ku = \kappa_P P \quad (12.86)$$

where the transformation factors for the linear elastic material (in Table 6.1) are used:

$$\begin{aligned} \kappa_M &= 0.406 \\ \kappa_P &= 0.533 \\ \kappa_K &= 0.533 \end{aligned} \quad (12.87)$$

The maximum displacement, u_{\max} , calculated by use of an OCTAVE program, developed for this project.

$$u_{\max} = 2.81 \text{ mm} \quad (12.88)$$

A very small deflection is achieved when having linear elastic material and the same elastic stiffness is used as in case of trilinear material.

12.4.2 Ideal plastic behaviour

In case of ideal plastic material the differential equation is:

$$M_e \ddot{u} + R_{me} = P_e \quad \text{when} \quad P(t) \geq R_m \quad \text{or} \quad u(t) \neq 0 \quad (12.89)$$

The maximum value of the internal force R_m is assumed to be the same as in case of trilinear material (see Equation (12.68)):

$$R_m = 502.4 \text{ kN} \quad (12.90)$$

Inserting Equations (12.70) into Equation (12.89) the differential equation is:

$$\kappa_M M\ddot{u} + \kappa_K R = \kappa_P P \quad (12.91)$$

where the transformation factors for the ideal plastic material (in Table 6.1) are used:

$$\begin{aligned} \kappa_M &= 1/3 \\ \kappa_P &= 0.5 \\ \kappa_K &= 0.5 \end{aligned} \quad (12.92)$$

The maximum displacement, u_{\max} , for the SDOF system, calculated by use of an OCTAVE program, developed for this project is:

$$u_{\max} = 32.7 \text{ mm} \quad (12.93)$$

The maximum value of the deflection for ideal plastic material, Equation (12.93), is lower than the maximum deflection achieved when using transformation factors for ideal plastic material in the analysis of trilinear material, Equation (12.82). This is expected since more energy is consumed initially in the ideal plastic material case.

Of the same reason, it can be probable that the maximum deflection in case of ideal plastic material shall be larger than when using transformation factors for linear elastic material in the trilinear material case. However, this can not be guaranteed since the equivalent mass in case of ideal plastic material is larger than for trilinear material when transformation factors for linear elastic material is used. When comparing Equations (12.93) and (12.77) it is seen that the displacement for the trilinear material is smaller than for ideal plastic material.

12.5 Example; not minimum amount of reinforcement

The beam analysed in Chapter 7 had a chosen amount of reinforcement not equal to the minimum amount, as in the example above. Since the beam is the same as used in Chapter 7 there is no need to calculate the load-displacement relation again, instead the values are found in Appendix D. However, the rotational capacities where not calculated in Appendix D, these calculations are made in Appendix I.

The maximum displacement, u_{\max} , for the SDOF system with trilinear material, when using transformation factors for linear elastic case, is:

$$u_{\max} = 18.3 \text{ mm} \quad (12.94)$$

If, instead, the transformation factors for the ideal plastic material is used the maximum deflection is:

$$u_{\max} = 22.4 \text{ mm} \quad (12.95)$$

Available rotational capacity, in support and field respectively, for the beam is, see Appendix I:

$$\theta_{d,pl,support} = 0.0090 \text{ rad} \quad (12.96)$$

$$\theta_{d,pl,field} = 0.0157 \text{ rad} \quad (12.97)$$

The required rotational rotation capacity, in support and field respectively, for the beam is, see Appendix I:

$$\theta_{pl,support} = 0.0132 \text{ rad} \quad (12.98)$$

$$\theta_{pl,field} = 0.0264 \text{ rad} \quad (12.99)$$

Also for this amount of reinforcement the available rotational capacity is smaller than the required rotational capacity.

In case of ideal plastic material the maximum deflection is:

$$u_{\max} = 18.1 \text{ mm} \quad (12.100)$$

The same comments as in Example above is applicationable here when comparing the maximum deflection for trilinear material with transformation factors for linear elastic and ideal plastic material, respectively. Also when comparing the maximum deflection when having ideal plastic material and transformation factors for the ideal plastic material in the analysis of the trilinear material the comments in example above are valid here. When comparing Equations (12.94) and (12.100) it is seen that the maximum displacement for ideal plastic material is smaller than the displacement for trilinear material with transformation factors for linear elastic material which was not the case in the example above.

13 Conclusions and ideas of further investigations

In this project simplified hand-calculation methods are compiled and discussed. For transient loads, for example loads caused by explosions, structures behave different from when subjected to static loads. Hence, the dynamic effects and the devastation they can cause is hard to take into account in the simplified hand-calculation methods. For example influences of higher modes and spread out yielding areas are not taken into account in the simplified calculation methods described in this thesis. Another thing, not taken to account in the hand-calculation methods, is that when a load with very short duration is applied to a beam large local deformations can occur in the application area before the rest of the beam is even aware of the load. This means that in order not to overlook any negative effects when designing with regard to explosions it is important that the real behaviour of the beam, or at least a good approximation of it, is known by the designer.

In this report the methodology of transforming beams to SDOF systems are shown and transformation factors for some typical cases and material behaviours are derived. The method of transforming deformable bodies into SDOF systems is useful since it simplifies the analyses of deformable structures subjected to transient loads. When the SDOF method is applicationable equivalent static loads, tabled beam equations and damage tables/curves can be used in order to simplify the analyses even more. However, due to limited available time the limit for when a load can be assumed to be an impulse load is not dealt with in this thesis but is worth further investigation.

The agreement between the response of beams calculated by use of SDOF systems and the real behaviour of the beam is investigated by comparing the results with results from FE analyses. When the FE models of the beams are made in order to imitate the assumed behaviour in the SDOF analyses the agreement between the results are good. However, this way of modelling can be questioned since the SDOF method must also agree with the real behaviour of the beams. When modelling the beams for a more realistic behaviour, where yielding can occur also in areas outside the points where plastic hinges are assumed to appear the agreement differs for different material behaviour. In case of linear elastic material the agreement is still accurate since there is no plasticity but in case of plastic effects the agreement is less pleasing; at least for beams subjected to concentrated loads. Hence the use of this method when analysing structures made of reinforced concrete shall be used with caution, at least before further, deeper and more carefully investigations are made.

When the SDOF method is used to analyse a wall in a shelter, represented by a reinforced concrete beam, subjected to a load corresponding to the load that the shelter shall withstand due to the Swedish shelter regulations, it turns out that the beam can not withstand the load. This indicates that either the equivalent load given in the Swedish shelter regulations are too small or the calculation method for the rotational capacity according to Svensk byggtjänst (1990) is too conservative.

However, even if the available rotational capacity is too small compared to the required rotational capacity this will probably not cause failure. The analyses used utilize simplifications and idealizations of the reality that result in capacities on the safe side.

14 References

WRITTEN SOURCES:

- ADINA (2004): *Theory and Modelling Guide Version 8.2.2*. ADINA R&D, Inc., Volume 1, Watertown, USA.
- Balazs, P. (1997): *Beräkningsmetoder vid stötvågsbelastade konstruktioner*. Avdelningen för vapen och skydd, Försvarets forskningsanstalt, Rapport FOA-R- -97-00473-311- -SE, Stockholm, Sweden.
- Bathe K.-J. (1996): *Finite Element Procedures*. Prentice Hall, Englewood Cliffs, New Jersey, USA.
- Boverket (2004): *Boverkets handbok om betongkonstruktioner BBK 04*. Boverket, Karlskrona, Sweden.
- Engström, B. (2001): *Beräkning av betong- och murverkskonstruktioner, Del II – Beräkningsmodeller*. Institutionen för konstruktionsteknik, Betongbyggnad, Chalmers University of Technology, Kompendium no. 94:2B, Sweden.
- Granström, S. (1958): *Beräkningsmetod för stötvågsbelastade konstruktioner*. Forsknings och försökssektionen, Befästningsbyrån, Kungliga Fortifikationsförvaltningen, Rapport nr 103:18, Sweden.
- Norris, C. (1959): *Structural Design for Dynamic Loads*. McGraw-Hill Book Company, Inc, USA.
- OCTAVE. Version 2.17.1.
- Räddningsverket (2004): *Sakkunnig fysiskt skydd, Seminarium om dynamisk påverkan*. Räddningsverket, Karlstad, Sweden.
- Räddningsverket (2003) *Skyddsrumregler SR, SR 03*. Räddningsverket, Karlstad, Sweden.
- Samuelsson, A., Wiberg, N-E. (1999): *Byggnadsmekanik Hållfasthetslära*. Studentlitteratur, No 2., Lund, Sweden.
- Svensk byggtjänst (1990): *Betonghandbok*, Svensk byggtjänst, Solna, Sweden.

ORAL SOURCES:

- Wendt, U (2006): Personal information from PhD Ulrika Wendt, Reinertsen Sverige AB. A report, written by Ulrika Wendt, concerning simplified design methods, among other things, will be publicised in the near future.

WEB SOURCES:

NATO (1996) *NATO Handbook on the Medical Aspects of NBC Defence Operations AMedP-6(B) Part I- Nuclear*. <http://www.fas.org/nuke/guide/usa/doctrine/dod/fm8-9/1toc.htm>.

KTH (2006) Notes for lesson in Structural Dynamics at the Royal institute of Technology, Stockholm. <http://www2.mech.kth.se/~jean/dynamics/dc8.ppt#6>.

APPENDIX A Transformation factors for linear elastic material

The transformation factors for linear elastic material are derived in Sections 6.2.1, 6.2.2 and 6.2.3.1:

$$\kappa_M = \frac{1}{L} \int_{x=0}^{x=L} \left(\frac{u(x,t)}{u_s(t)} \right)^2 dx \quad (\text{A.1})$$

$$\kappa_P = \frac{\int_{x=0}^{x=L} \frac{u(x,t)}{u_s(t)} q(x,t) dx}{\int_{x=0}^{x=L} q(x,t) dx} \quad (\text{A.2})$$

$$\kappa_K = \frac{1}{u_s} \frac{\int_{x=0}^{x=L} M(x) u''(x) dx}{\int_{x=0}^{x=L} q(x,t) dx} \quad (\text{A.3})$$

In case of concentrated loads applied in the system point $\int_{x=0}^{x=L} q(x,t) dx = P(t)$ and the transformation factor for the load Equation (A.2) can be written as:

$$\kappa_P = \frac{\int_{x=0}^{x=L} \frac{u(x,t)}{u_s(t)} q(x,t) dx}{P(t)} = \frac{u(x_s,t)}{u_s(t)} \frac{P(t)}{P(t)} = 1.0000 \quad (\text{A.4})$$

The relation between the bending moment and the curvature $u''(x)$ is, in case of linear elastic material:

$$u''(x) = \frac{M(x)}{EI} \quad (\text{A.5})$$

The transformation factor for the internal force in Equation (A.3) when the beam is subjected to a concentrated load can thus be written as:

$$\kappa_K = \frac{1}{u_s EI} \frac{\int_{x=0}^{x=L} M(x)^2 dx}{P(t)} \quad (\text{A.6})$$

The transformation factor for the mass Equation (A.1) is not influenced by the load shape.

In case of a uniformly distributed load $\int_{x=0}^{x=L} q(x,t)dx = q(t) \cdot L$ and the transformation factor for the load in Equation (A.2) can be written as:

$$\kappa_p = \frac{q(t)}{q(t) \cdot L} \int_{x=0}^{x=L} \frac{u(x,t)}{u_s(t)} dx = \frac{1}{L} \int_{x=0}^{x=L} \frac{u(x,t)}{u_s(t)} dx \quad (\text{A.7})$$

By use of Equation (A.5) the transformation factor for the internal force in Equation (A.3) when the beam is subjected to a uniformly distributed load can be written as:

$$\kappa_K = \frac{1}{u_s EI} \frac{\int_{x=0}^{x=L} M(x)^2 dx}{q(t) \cdot L} \quad (\text{A.8})$$

A.1 Case (1.1)

For a simply supported beam subjected to a concentrated load, as in Figure A.1, the deflection along the beam (tabled in Samuelsson and Wiberg (1999)) is:

$$u(x) = \frac{L^2}{48EI} \left(3x - \frac{4x^3}{L^2} \right) \cdot P \quad \text{for } 0 < x \leq \frac{L}{2} \quad (\text{A.9})$$

where x is a coordinate in longitudinal direction with start point at one end of the beam.

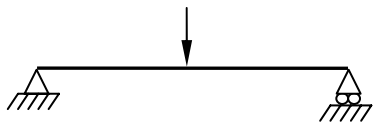

Figure A.1 Simply supported beam subjected to a concentrated load.

The deflection of the system point, located in the middle of the beam, is:

$$u_s = u(x = L/2) = \frac{PL^3}{48EI} \quad (\text{A.10})$$

By rearranging the terms in Equation (A.10) the expression for the load can be written as:

$$P = \frac{48EI}{L^3} u_s \quad (\text{A.11})$$

and the moment distribution along the beam can be expressed as:

$$M(x) = \frac{Px}{2} \quad \text{for } 0 < x \leq \frac{L}{2} \quad (\text{A.12})$$

By means of Equation (A.1) and due to symmetry the transformation factor for the mass can be calculated as:

$$\begin{aligned} \kappa_M &= \frac{2}{L} \int_{x=0}^{x=L/2} \left(\frac{48EI}{L^3} \cdot \frac{L^2}{48EI} \left(3x - \frac{4x^3}{L^2} \right) \right)^2 dx = \\ &= \frac{2}{L^3} \int_{x=0}^{x=L/2} \left(9x^2 - 24 \frac{x^4}{L^2} + 16 \frac{x^6}{L^4} \right) dx = \\ &= \frac{2}{L^3} \left[3x^2 - \frac{24}{5} \frac{x^5}{L^2} + \frac{16}{7} \frac{x^7}{L^4} \right]_{x=0}^{x=L/2} = 0.4857 \end{aligned} \quad (\text{A.13})$$

Concentrated load applied in the system point gives (see Equation (A.4)):

$$\kappa_P = 1.0000 \quad (\text{A.14})$$

By inserting Equations (A.10) to (A.12) into Equation (A.6) the transformation factor for the internal force is calculated.

$$\begin{aligned} \kappa_K &= \frac{1}{Pu_s EI} \int_{x=0}^{x=L} M(x)^2 dx = \frac{L^3}{48EI} \frac{2}{u_s^2 EI} \int_{x=0}^{x=L/2} \left(\frac{Px}{2} \right)^2 dx = \\ &= \frac{L^3}{48EI} \frac{48^2 EI}{2L^6} \int_{x=0}^{x=L/2} x^2 dx = \frac{24}{L^3} \left[\frac{x^3}{3} \right]_{x=0}^{x=L/2} = 1.0000 \end{aligned} \quad (\text{A.15})$$

Finally the values of κ_{MP} and κ_{KP} are calculated.

$$\kappa_{MP} = \kappa_M / \kappa_P = 0.4857 / 1.0000 = 0.4857 \quad (\text{A.16})$$

$$\kappa_{KP} = \kappa_K / \kappa_P = 1.0000 / 1.0000 = 1.0000 \quad (\text{A.17})$$

A.2 Case (1.2)

For a simply supported beam subjected to a uniformly distributed load, as in Figure A.2, the deflection along the beam (tabled in Samuelsson and Wiberg (1999)) is:

$$u(x) = \frac{L^3}{24EI} \left(x - \frac{2x^3}{L^2} + \frac{x^4}{L^3} \right) \cdot q \quad (\text{A.18})$$

where x is a coordinate in longitudinal direction with start point at one end of the beam.

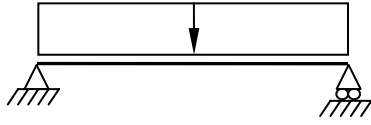

Figure A.2 Simply supported beam subjected to a uniformly distributed load.

The deflection of the system point, located in the middle of the beam, is:

$$u_s = u(x = L/2) = \frac{5qL^4}{384EI} \quad (\text{A.19})$$

By rearranging the terms in Equation (A.19) the expression for the load can be written as:

$$q \cdot L = \frac{384EI}{5L^3} u_s \quad (\text{A.20})$$

and the moment distribution along the beam can be expressed as:

$$M(x) = \frac{qL}{2}x - \frac{q}{2}x^2 \quad (\text{A.21})$$

By means of Equation (A.1) the transformation factor for the mass can be calculated as:

$$\begin{aligned} \kappa_M &= \frac{1}{L} \int_{x=0}^{x=L} \left(\frac{16}{5L} \left(x - \frac{2x^3}{L^2} + \frac{x^4}{L^3} \right) \right)^2 dx = \\ &= \frac{256}{25 \cdot L^3} \left[\frac{1}{3}x^3 - \frac{4}{5} \frac{x^5}{L^2} + \frac{2}{6} \frac{x^6}{L^3} + \frac{4}{7} \frac{x^7}{L^4} - \frac{4}{8} \frac{x^8}{L^5} + \frac{1}{9} \frac{x^9}{L^6} \right]_{x=0}^{x=L} = \\ &= 0.5039 \end{aligned} \quad (\text{A.22})$$

Uniformly distributed load gives (see Equation (A.7)):

$$\begin{aligned} \kappa_P &= \frac{1}{L} \int_{x=0}^{x=L} \left(\frac{16}{5L} \left(x - \frac{2x^3}{L^2} + \frac{x^4}{L^3} \right) \right) dx = \frac{16}{5L^2} \left[\frac{x^2}{2} - \frac{x^4}{2L^2} + \frac{x^5}{5L^3} \right]_{x=0}^{x=L} = \\ &= \frac{16}{25} = 0.6400 \end{aligned} \quad (\text{A.23})$$

By inserting Equations (A.19) to (A.21) into Equation (A.8) the transformation factor for the internal force is calculated.

$$\begin{aligned}
\kappa_K &= \frac{1}{qLu_s EI} \int_{x=0}^{x=L} \left(\frac{qL}{2}x - \frac{qL^2}{12} - \frac{q}{2}x^2 \right)^2 dx = \\
&= \frac{384^2 EI u_s^2}{5^2 \cdot 4 \cdot L^8 u_s} \int_{x=0}^{x=L} (Lx - x^2)^2 dx = \\
&= \frac{384}{5 \cdot 4 \cdot L^5} \left[\frac{L^2 x^3}{3} + \frac{x^5}{5} - \frac{Lx^4}{2} \right]_{x=0}^{x=L} = \frac{16}{25} = 0.6400
\end{aligned} \tag{A.24}$$

Finally the values of κ_{MP} and κ_{KP} are calculated.

$$\kappa_{MP} = \kappa_M / \kappa_P = 0.5039 / 0.6400 = 0.7873 \tag{A.25}$$

$$\kappa_{KP} = \kappa_K / \kappa_P = 0.6400 / 0.6400 = 1.0000 \tag{A.26}$$

A.3 Case (2.1)

For a fixed beam subjected to a concentrated load, as in Figure A.3, the deflection along the beam (tabled in Samuelsson and Wiberg (1999)) is:

$$u(x) = \frac{L}{48EI} \left(3x^2 - \frac{4x^3}{L} \right) \cdot P \quad \text{for } 0 < x \leq \frac{L}{2} \tag{A.27}$$

where x is a coordinate in longitudinal direction with start point at one end of the beam.

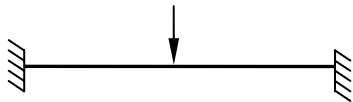

Figure A.3 Fixed beam subjected to a concentrated load.

The deflection of the system point, located in the middle of the beam, is:

$$u_s = u(x = L/2) = \frac{PL^3}{192EI} \tag{A.28}$$

By rearranging the terms in Equation (A.28) the expression for the load can be written as:

$$P = \frac{192EI}{L^3} u_s \tag{A.29}$$

and the moment distribution along the beam can be expressed as:

$$M(x) = \frac{Px}{2} - \frac{PL}{8} \quad \text{for } 0 < x \leq \frac{L}{2} \quad (\text{A.30})$$

By means of Equation (A.1) and due to symmetry the transformation factor for the mass can be calculated as:

$$\begin{aligned} \kappa_M &= \frac{2}{L} \int_{x=0}^{x=L/2} \left(\frac{4}{L^2} \left(3x^2 - \frac{4x^3}{L} \right) \right)^2 dx = \\ &= \frac{32}{L^5} \left[\frac{9}{5} x^5 + \frac{24}{6} \frac{x^6}{L} + \frac{16}{7} \frac{x^7}{L^2} \right]_{x=0}^{x=L/2} = 0.3714 \end{aligned} \quad (\text{A.31})$$

Concentrated load applied in the system point gives (see Equation (A.4)):

$$\kappa_P = 1.0000 \quad (\text{A.32})$$

By inserting Equations (A.28) to (A.30) into Equation (A.6) the transformation factor for the internal force is calculated.

$$\begin{aligned} \kappa_K &= \frac{L^3}{192EI} \frac{2}{u_s^2 EI} \int_{x=0}^{x=L/2} \left(\frac{Px}{2} - \frac{PL}{8} \right)^2 dx = \\ &= \frac{L^3}{192EI} \frac{192^2 EI}{2L^6} \int_{x=0}^{x=L/2} \left(x^2 + \frac{L^2}{16} - \frac{Lx}{2} \right) dx = \\ &= \frac{192}{2L^3} \left[\frac{x^3}{3} + \frac{L^2 x}{16} - \frac{Lx^2}{4} \right]_{x=0}^{x=L/2} = 1.0000 \end{aligned} \quad (\text{A.33})$$

Finally the values of κ_{MP} and κ_{KP} are calculated.

$$\kappa_{MP} = \kappa_M / \kappa_P = 0.3714 / 1.0000 = 0.3714 \quad (\text{A.34})$$

$$\kappa_{KP} = \kappa_K / \kappa_P = 1.0000 / 1.0000 = 1.0000 \quad (\text{A.35})$$

A.4 Case (2.2)

For a simply supported beam subjected to a uniformly distributed load, as in Figure A.4, the deflection along the beam (tabled in Samuelsson and Wiberg (1999)) is:

$$u(x) = \frac{x^2 L^2}{24EI} \left(1 - \frac{x}{L} \right)^2 \cdot q \quad (\text{A.36})$$

where x is a coordinate in longitudinal direction with start point at one end of the beam.

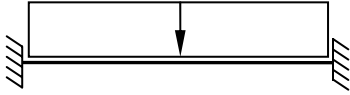

Figure A.4 Fixed beam subjected to a uniformly distributed load.

The deflection of the system point, located in the middle of the beam, is:

$$u_s = u(x = L/2) = \frac{qL^4}{384EI} \quad (\text{A.37})$$

By rearranging the terms in Equation (A.37) the expression for the load can be written as:

$$q \cdot L = \frac{384EI}{L^3} u_s \quad (\text{A.38})$$

and the moment distribution along the beam can be expressed as:

$$M(x) = \frac{qL}{2} x - \frac{qL^2}{12} - \frac{q}{2} x^2 \quad (\text{A.39})$$

By means of Equation (A.1) the transformation factor for the mass can be calculated as:

$$\begin{aligned} \kappa_M &= \frac{1}{L} \int_{x=0}^{x=L} \left(\frac{16}{L^2} x^2 \left(1 + \frac{x^2}{L^2} - 2 \frac{x}{L} \right) \right)^2 dx = \\ &= \frac{16^2}{L} \left[\frac{1}{5} \frac{x^5}{L^4} + \frac{2}{3} \frac{x^6}{L^5} + \frac{6}{7} \frac{x^7}{L^6} - \frac{1}{2} \frac{x^8}{L^7} + \frac{1}{9} \frac{x^9}{L^8} \right]_{x=0}^{x=L} = 0.4063 \end{aligned} \quad (\text{A.40})$$

Uniformly distributed load gives (see Equation (A.7)):

$$\begin{aligned} \kappa_P &= \frac{1}{L} \int_{x=0}^{x=L} \left(\frac{16}{L^2} x^2 \left(1 + \frac{x^2}{L^2} - 2 \frac{x}{L} \right) \right) dx = \\ &= \frac{16}{L} \left[\frac{1}{3} \frac{x^3}{L^2} - \frac{1}{2} \frac{x^4}{L^3} + \frac{1}{5} \frac{x^5}{L^4} \right]_{x=0}^{x=L} = 0.5333 \end{aligned} \quad (\text{A.41})$$

By inserting Equations (A.37) to (A.39) into Equation (A.8) the transformation factor for the internal force is calculated.

$$\begin{aligned}
\kappa_K &= \frac{1}{qLu_s EI} \int_{x=0}^{x=L} \left(\frac{qL}{2}x - \frac{q}{2}x^2 \right)^2 dx = \\
&= \frac{L^3}{384EIu_s} \frac{1}{u_s EI} \int_{x=0}^{x=L} \left(\frac{qL}{2}x - \frac{q}{2}x^2 \right)^2 dx = \\
&= \frac{384}{4 \cdot L^5} \int_{x=0}^{x=L} \left(Lx - \frac{L^2}{6} - x^2 \right)^2 dx = \\
&= \frac{96}{L^5} \left[\frac{L^4 x}{36} - \frac{L^3 x^2}{6} + \frac{4L^2 x^3}{9} - \frac{Lx^4}{2} + \frac{x^5}{5} \right]_{x=0}^{x=L} = \frac{8}{15} = 0.5333
\end{aligned} \tag{A.42}$$

Finally the values of κ_{MP} and κ_{KP} are calculated.

$$\kappa_{MP} = \kappa_M / \kappa_P = 0.4063 / 0.5333 = 0.7619 \tag{A.43}$$

$$\kappa_{KP} = \kappa_K / \kappa_P = 0.5333 / 0.5333 = 1.0000 \tag{A.44}$$

A.5 Case (3.1)

For a cantilever beam subjected to a concentrated load, as in Figure A.5, the deflection along the beam (tabled in Samuelsson and Wiberg (1999)) is:

$$u(x) = \frac{x^2 L}{2EI} \left(1 - \frac{x}{3L} \right) \cdot P \tag{A.45}$$

where x is a coordinate in longitudinal direction with start point at the support.

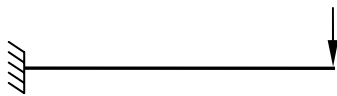

Figure A.5 Cantilever beam subjected to a concentrated load.

The deflection of the system point, located in the free end of the beam, is:

$$u_s = u(x = L) = \frac{PL^3}{3EI} \tag{A.46}$$

By rearranging the terms in Equation (A.46) the expression for the load can be written as:

$$P = \frac{3EI}{L^3} u_s \tag{A.47}$$

and the moment distribution along the beam can be expressed as:

$$M(x) = Px - PL \quad (\text{A.48})$$

By means of Equation (A.1) the transformation factor for the mass can be calculated as:

$$\begin{aligned} \kappa_M &= \frac{1}{L} \int_{x=0}^{x=L} \left(\frac{3x^2}{2L^2} \left(1 - \frac{x}{3L} \right) \right)^2 dx = \\ &= \frac{1}{4L^5} \left[\frac{9}{5} x^5 + \frac{1}{7} \frac{x^7}{L^2} - \frac{x^6}{L} \right]_{x=0}^{x=L} = 0.2357 \end{aligned} \quad (\text{A.49})$$

Concentrated load applied in the system point gives (see Equation (A.4)):

$$\kappa_p = 1.0000 \quad (\text{A.50})$$

By inserting Equations (A.46) to (A.48) into Equation (A.6) the transformation factor for the internal force is calculated.

$$\begin{aligned} \kappa_K &= \frac{1}{u_s EIP} \int_{x=0}^{x=L} (Px - PL)^2 dx = \\ &= \frac{P}{u_s EI} \int_{x=0}^{x=L} (x^2 - 2Lx + L^2) dx = \\ &= \frac{3}{L^3} \left[\frac{x^3}{3} - Lx^2 + L^2x \right]_{x=0}^{x=L} = 1.0000 \end{aligned} \quad (\text{A.51})$$

Finally the values of κ_{MP} and κ_{KP} are calculated.

$$\kappa_{MP} = \kappa_M / \kappa_p = 0.2357 / 1.0000 = 0.2357 \quad (\text{A.52})$$

$$\kappa_{KP} = \kappa_K / \kappa_p = 1.0000 / 1.0000 = 1.0000 \quad (\text{A.53})$$

A.6 Case (3.2)

For a cantilever beam subjected to a uniformly distributed load, as in Figure A.6, the deflection along the beam (tabled in Samuelsson and Wiberg (1999)) is:

$$u(x) = \frac{x^2 L^2}{24EI} \left(6 - \frac{4x}{L} + \frac{x^2}{L^2} \right)^2 \cdot q \quad (\text{A.54})$$

where x is a coordinate in longitudinal direction with start point at the support.

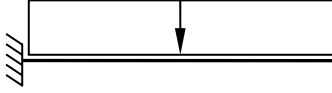

Figure A.6 Cantilever beam subjected to a uniformly distributed load.

The deflection of the system point, located in the free end of the beam, is:

$$u_s = u(x = L) = \frac{qL^4}{8EI} \quad (\text{A.55})$$

By rearranging the terms in Equation (A.37) the expression for the load can be written as:

$$q \cdot L = \frac{8EI}{L^3} u_s \quad (\text{A.56})$$

and the moment distribution along the beam can be expressed as:

$$M(x) = qLx - \frac{qL^2}{2} - \frac{q}{2} x^2 \quad (\text{A.57})$$

By means of Equation (A.1) the transformation factor for the mass can be calculated as:

$$\begin{aligned} \kappa_M &= \frac{1}{L} \int_{x=0}^{x=L} \left(\frac{1}{3L^2} x^2 \left(6 + \frac{x^2}{L^2} - 4 \frac{x}{L} \right) \right)^2 dx = \\ &= \frac{1}{9L} \left[\frac{36}{5} \frac{x^5}{L^4} + \frac{8x^6}{L^5} + \frac{4x^7}{L^6} - \frac{x^8}{L^7} + \frac{1}{9} \frac{x^9}{L^8} \right]_{x=0}^{x=L} = 0.2568 \end{aligned} \quad (\text{A.58})$$

Uniformly distributed load gives (see Equation (A.7)):

$$\begin{aligned} \kappa_P &= \frac{1}{L} \int_{x=0}^{x=L} \left(\frac{x^2}{3L^2} \left(6 + \frac{x^2}{L^2} - 4 \frac{x}{L} \right) \right) dx = \\ &= \frac{1}{L} \left[\frac{2}{3} \frac{x^3}{L^2} - \frac{1}{3} \frac{x^4}{L^3} + \frac{1}{15} \frac{x^5}{L^4} \right]_{x=0}^{x=L} = 0.4000 \end{aligned} \quad (\text{A.59})$$

By inserting Equations (A.55) to (A.57) into Equation (A.8) the transformation factor for the internal force is calculated.

$$\begin{aligned}
\kappa_K &= \frac{1}{qLu_s EI} \int_{x=0}^{x=L} \left(qLx - \frac{qL^2}{2} - \frac{q}{2} x^2 \right)^2 dx = \\
&= \frac{8}{L^5} \int_{x=0}^{x=L} \left(Lx - \frac{L^2}{2} - \frac{x^2}{2} \right)^2 dx = \\
&= \frac{8}{L^5} \int_{x=0}^{x=L} \left(\frac{L^4}{4} - L^3x + \frac{3L^2x^2}{2} - Lx^3 + \frac{x^4}{4} \right) dx = \\
&= \frac{8}{L^5} \left[\frac{L^4x}{4} - \frac{L^3x^2}{2} + \frac{L^2x^3}{2} - \frac{Lx^4}{4} + \frac{x^5}{20} \right]_{x=0}^{x=L} = \frac{2}{5} = 0.4000
\end{aligned} \tag{A.60}$$

Finally the values of κ_{MP} and κ_{MP} are calculated.

$$\kappa_{MP} = \kappa_M / \kappa_P = 0.2568 / 0.4000 = 0.6420 \tag{A.61}$$

$$\kappa_{KP} = \kappa_K / \kappa_P = 0.4000 / 0.4000 = 1.0000 \tag{A.62}$$

APPENDIX B Transformation factors for ideal plastic material

The transformation factors for ideal plastic material are derived in Sections 6.2.1, 6.2.2 and 6.2.3.2:

$$\kappa_M = \frac{1}{L} \int_{x=0}^{x=L} \left(\frac{u(x,t)}{u_s(t)} \right)^2 dx \quad (\text{B.1})$$

$$\kappa_P = \frac{\int_{x=0}^{x=L} \frac{u(x,t)}{u_s(t)} q(x,t) dx}{\int_{x=0}^{x=L} q(x,t) dx} \quad (\text{B.2})$$

$$\kappa_K = \frac{1}{R_m u_s} \int_{x=0}^{x=L} M u''(x) dx = \frac{1}{u_s} \frac{\int_{x=0}^{x=L} M u''(x) dx}{\int_{x=0}^{x=L} q(x,t) dx} \quad (\text{B.3})$$

B.1 Case (1.1) and (1.2)

For a simply supported beam one plastic hinge will develop in the middle of the beam (the system point) if the load is symmetrical. The mechanisms in case of a concentrated and uniformly distributed load respectively can be seen in Figure B.1.

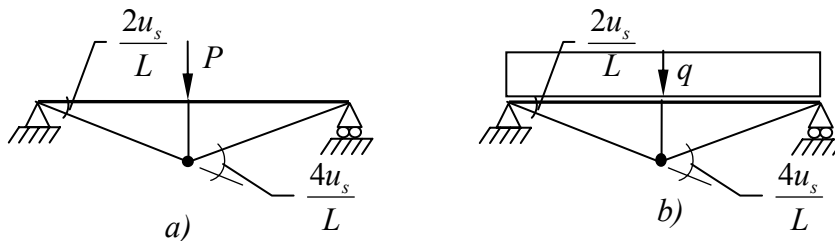

Figure B.1 Simply supported beam subjected to a) concentrated load b) uniformly distributed load.

The deflection $u(x)$ along the beam can be expressed as:

$$u(x) = u_s \frac{2}{L} x \quad \text{for } x < L/2 \quad (\text{B.4})$$

where u_s is the displacement of the system point, x is a coordinate in longitudinal direction of the beam with start point at one end of the beam and L is the length of the beam.

The first derivative of $u(x)$ is:

$$u'(x) = u_s \frac{2}{L} \quad \text{for } x < L/2 \quad (\text{B.5})$$

Equation (B.1) gives the expression of the transformation factor for the mass:

$$\kappa_M = \frac{1}{L} \int_{x=0}^{x=L} \left(\frac{u(x,t)}{u_s(t)} \right)^2 dx \quad (\text{B.6})$$

By means of Equation (B.4) this expression can be rewritten as:

$$\kappa_M = \frac{2}{L} \int_{x=0}^{x=L/2} \left(\frac{2x}{L} \right)^2 dx = \frac{1}{3} \quad (\text{B.7})$$

The value of the transformation factor for mass is the same for both case (1.1) and (1.2) in case of ideal plastic material.

The transformation factor for the load is (see Equation (B.2)):

$$\kappa_P = \frac{\int_{x=0}^{x=L} \frac{u(x,t)}{u_s(t)} q(x,t) dx}{\int_{x=0}^{x=L} q(x,t) dx} \quad (\text{B.8})$$

In case of concentrated load acting in the system point Equation (B.8) can be written as:

$$\kappa_P = \frac{\int_{x=(L/2)^-}^{x=(L/2)^+} \frac{u(x,t)}{u_s(t)} q(x,t) dx}{\int_{x=0}^{x=L} q(x,t) dx} = \frac{1}{P} \frac{u_s P}{u_s} = 1.0000 \quad (\text{B.9})$$

since $\int_{x=0}^{x=L} q(x,t) dx = P$ and $q(x,t) = 0$ when $x \neq L/2$

By means of Equation (B.4) the expression for transformation factor in Equation (B.8) in case of a uniformly distributed load can be written as:

$$\kappa_p = \frac{2 \int_{x=0}^{x=L/2} \frac{2x}{L} q(x,t) dx}{\int_{x=0}^{x=L} q(x,t) dx} \quad (\text{B.10})$$

The expression for the transformation factor for the internal resisting force, when having an ideal plastic material is (see Equation (B.3)):

$$\kappa_K = \frac{1}{R_m u_s} \int_{x=0}^{x=L} M u''(x) dx \quad (\text{B.11})$$

The curvature $u''(x)$ is zero everywhere in the beam except in the system point (which is located in the middle of the beam) where the moment has a known constant value, Equation (B.11) can be written as:

$$\kappa_K = \frac{1}{R_m u_s} \int_{(L/2)^-}^{(L/2)^+} M u''(x) dx = \frac{M_{pl}}{R_m u_s} \int_{(L/2)^-}^{(L/2)^+} u''(x) dx \quad (\text{B.12})$$

The integral of the curvature in the system point is one way to express the change of the angle in this point. Due to symmetry the change of angle in the system point is twice the change of angle over the supports.

$$\int_{(L/2)^-}^{(L/2)^+} u''(x) dx = u'(L/2) = 2 \cdot u'(0) = 2 \cdot u'(L) = 4 \frac{u_s}{L} \quad (\text{B.13})$$

The maximum internal resistance R_m is equal to the external load needed to create the mechanism, P_{pl} , (or $q_{pl} \cdot L$ for uniformly distributed load) (see

Figure B.1). The moment in the system point is equal to the plastic moment, M_{pl} .

B.1.1 Case (1.1)

For a simply supported beam subjected to a concentrated load (see

Figure B.1.a) the plastic moment is:

$$M_{pl} = \frac{P_{pl} L}{4} \quad (\text{B.14})$$

Equation (B.9) gives the transformation factor for the load for case (1.1).

$$\kappa_p = 1.0000 \quad (\text{B.15})$$

Equations (B.13) and (B.14) inserted into Equation (B.12) gives the transformation factor for the internal resisting force for case (1.1).

$$\kappa_K = \frac{M_{pl}}{R_m u_s} \int_{(L/2)^-}^{(L/2)^+} u''(x) dx = \frac{P_{pl} \cdot L}{4} \frac{1}{R_m u_s} 4 \frac{u_s}{L} = \frac{P_{pl}}{R_m} = \frac{P_{pl}}{P_{pl}} = 1.0000 \quad (\text{B.16})$$

B.1.2 Case (1.2)

For a simply supported beam subjected to a uniformly distributed load (see Figure B.1.b) the plastic moment is:

$$M_{pl} = \frac{q_{pl} L^2}{8} \quad (\text{B.17})$$

Equation (B.10) gives the transformation factor for the load for case (1.2).

$$\kappa_P = \frac{2 \int_{x=0}^{x=L/2} \frac{2x}{L} q(x,t) dx}{\int_{x=0}^{x=L} q(x,t) dx} = \frac{4q}{L} \frac{\int_{x=0}^{x=L/2} x dx}{q \cdot L} = \frac{4}{L^2} \left[\frac{x^2}{2} \right]_{x=0}^{x=L/2} = \frac{1}{2} \quad (\text{B.18})$$

Equation (B.13) and (B.17) inserted in Equation (B.12) gives the transformation factor for the internal resisting force for case (1.2).

$$\kappa_K = \frac{M_{pl}}{R_m u_s} \int_{(L/2)^-}^{(L/2)^+} u''(x) dx = \frac{q_{pl} L^2}{8} \frac{1}{R_m u_s} \frac{4u_s}{L} = \frac{1}{2} \frac{q_{pl} L}{q_{pl} L} = \frac{1}{2} \quad (\text{B.19})$$

B.2 Case (2.1) and (2.2)

For a beam fixed at both ends there will be one plastic hinge in the middle of the beam (the system point) and one hinge at each support if the load is symmetrical. The mechanism can be seen in Figure B.2.

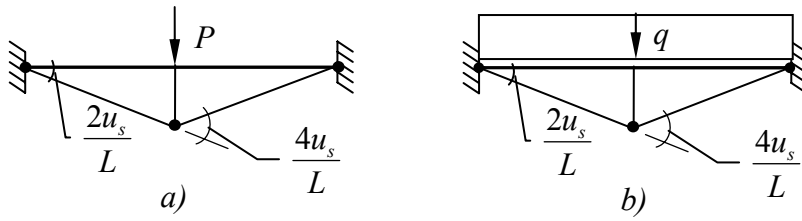

Figure B.2 Fixed beam subjected to a) concentrated load b) uniformly distributed load.

The deflection $u(x)$ along the beam can be expressed as:

$$u(x) = u_s \frac{2}{L} x \quad \text{for } x < L/2 \quad (\text{B.20})$$

where u_s is the displacement of the system point, x is a coordinate in longitudinal direction of the beam with start point at one end of the beam and L is the length of the beam.

And the first derivative of $u(x)$ is:

$$u'(x) = u_s \frac{2}{L} \quad (\text{B.21})$$

Since the mechanisms in case (2.1) and (2.2) are the same as in case (1.1) and (1.2) respectively the transformation factors for the mass and the load calculated in Appendix B.1 can be used. The transformation factor for the mass is than:

$$\kappa_M = \frac{2}{L} \int_{x=0}^{x=L/2} \left(\frac{2x}{L} \right)^2 dx = \frac{1}{3} \quad (\text{B.22})$$

The value of the transformation factor for mass is the same for both case (2.1) and (2.2). The transformation factor of the load depends on the shape of the load and differs in case (2.1) and (2.2).

The expression for the transformation factor for the internal resisting load when having an ideal plastic material is (see Equation (6.42)).

$$\kappa_K = \frac{1}{R_m u_s} \int_{x=0}^{x=L} M u''(x) dx \quad (\text{B.23})$$

The curvature $u''(x)$ is zero everywhere in the beam except in the hinges where the moment has a known constant value. Equation (B.23) can be written as:

$$\begin{aligned}\kappa_K &= \frac{1}{R_m u_s} \left(\int_{0^-}^{0^+} M u''(x) dx + \int_{(L/2)^-}^{(L/2)^+} M u''(x) dx + \int_{L^-}^{L^+} M u''(x) dx \right) = \\ &= \frac{M_{pl}}{R_m u_s} \left(\int_{0^-}^{0^+} u''(x) dx + \int_{(L/2)^-}^{(L/2)^+} u''(x) dx + \int_{L^-}^{L^+} u''(x) dx \right)\end{aligned}\quad (\text{B.24})$$

The integral of the curvature in the hinges is one way to express the change of the angle in these points. Due to symmetry the change of angle in the system point is twice the change of angle over the supports.

$$\int_{(L/2)^-}^{(L/2)^+} u''(x) dx = u'(L/2) = 2 \cdot u'(0) = 2 \cdot u'(L) = 4 \frac{u_s}{L} \quad (\text{B.25})$$

The maximum internal resistance R_m is equal to the external load needed to create the mechanism, P_{pl} , (or $q_{pl} \cdot L$ for uniformly distributed load) (see Figure B.2). The moment in the system point is equal to the plastic moment, M_{pl} .

B.2.1 Case (2.1)

For a beam subjected to a concentrated load (see Figure B.2.a) the plastic moment is:

$$M_{pl} = \frac{P_{pl} L}{8} \quad (\text{B.26})$$

The transformation factor for the load is the same as in case (1.1).

$$\kappa_p = 1.0000 \quad (\text{B.27})$$

Equation (B.25) and (B.26) inserted in Equation (B.23) gives the transformation factor for the internal resisting force for case (2.1).

$$\begin{aligned}\kappa_K &= \frac{M_{pl}}{R_m u_s} \left(\int_{0^-}^{0^+} u''(x) dx + \int_{(L/2)^-}^{(L/2)^+} u''(x) dx + \int_{L^-}^{L^+} u''(x) dx \right) = \\ &= \frac{P_{pl} L}{8} \frac{1}{R_m u_s} \left(\frac{2u_s}{L} + \frac{4u_s}{L} + \frac{2u_s}{L} \right) = \frac{P_{pl}}{R_m} = \frac{P_{pl}}{P_{pl}} = 1.0000\end{aligned}\quad (\text{B.28})$$

B.2.2 Case (2.2)

For a beam subjected to a uniformly distributed load (see Figure B.2.b) the plastic moment is:

$$M_{pl} = \frac{q_{pl}L^2}{16} \quad (\text{B.29})$$

The transformation factor for the load is the same as in case (1.2).

$$\kappa_p = \frac{1}{2} \quad (\text{B.30})$$

Equation (B.25) and (B.29) inserted in Equation (B.23) gives the transformation factor for the internal resisting force for case (2.2).

$$\begin{aligned} \kappa_K &= \frac{M_{pl}}{R_m u_s} \left(\int_{0^-}^{0^+} u''(x) dx + \int_{(L/2)^-}^{(L/2)^+} u''(x) dx + \int_{L^-}^{L^+} u''(x) dx \right) = \\ &= \frac{q_{pl}L^2}{16} \frac{1}{R_m u_s} \left(\frac{2u_s}{L} + \frac{4u_s}{L} + \frac{2u_s}{L} \right) = \frac{q_{pl}L}{2R_m} = \frac{q_{pl}L}{2q_{pl}L} = \frac{1}{2} \end{aligned} \quad (\text{B.31})$$

B.3 Case (3.1) and (3.2)

For a cantilever beam there will be one plastic hinge at the support. The mechanism can be seen in

Figure B.3.

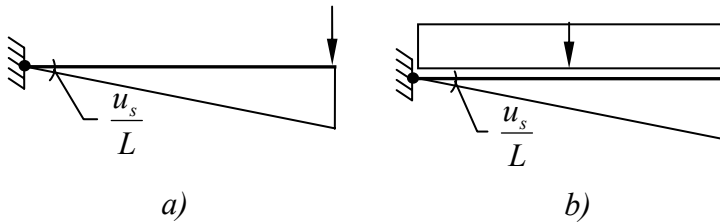

Figure B.3 Cantilever beam subjected to a) concentrated load b) uniformly distributed load.

The deflection $u(x)$ along the beam can be expressed as:

$$u(x) = \frac{u_s}{L} x \quad (\text{B.32})$$

where u_s is the displacement of the system point, x is a coordinate in longitudinal direction of the beam with start point at one end of the beam and L is the length of the beam.

And the first derivative of $u(x)$ is:

$$u'(x) = \frac{u_s}{L} \quad (\text{B.33})$$

Equation (6.18) gives the expression of the transformation factor for the mass:

$$\kappa_M = \frac{1}{L} \int_{x=0}^{x=L} \left(\frac{u(x,t)}{u_s(t)} \right)^2 dx \quad (\text{B.34})$$

By means of Equation (B.32) this expression can be rewritten as:

$$\kappa_M = \frac{1}{L} \int_{x=0}^{x=L} \left(\frac{x}{L} \right)^2 dx = \frac{1}{L^3} \left[\frac{x^3}{3} \right]_{x=0}^{x=L} = \frac{1}{3} \quad (\text{B.35})$$

The value of the transformation factor for mass is the same for both case (3.1) and (3.2).

The transformation factor for the load is (see Equation (6.22)):

$$\kappa_P = \frac{\int_{x=0}^{x=L} \frac{u(x,t)}{u_s(t)} q(x,t) dx}{\int_{x=0}^{x=L} q(x,t) dx} \quad (\text{B.36})$$

In case of concentrated load acting in the system point Equation (B.36) can be written as:

$$\kappa_P = \frac{\int_{x=L^-}^{x=L^+} \frac{u(x,t)}{u_s(t)} q(x,t) dx}{\int_{x=0}^{x=L} q(x,t) dx} = \frac{1}{P} \frac{u_s P}{u_s} = 1.0000 \quad (\text{B.37})$$

since $\int_{x=0}^{x=L} q(x,t) dx = P$ and $q(x,t) = 0$ when $x \neq L$

By means of Equation (B.32) the expression for transformation factor in Equation (B.36) in case of a uniformly distributed load can be written as:

$$\kappa_P = \frac{\int_{x=0}^{x=L} \frac{x}{L} q(x,t) dx}{\int_{x=0}^{x=L} q(x,t) dx} \quad (\text{B.38})$$

The expression for the transformation factor for the internal resisting load when having an ideal plastic material is (see Equation (6.42)):

$$\kappa_K = \frac{1}{R_m u_s} \int_{x=0}^{x=L} M u''(x) dx \quad (\text{B.39})$$

The curvature $u''(x)$ is zero everywhere in the beam except in the plastic hinge where the moment has a known constant value. Equation (B.39) can be written as:

$$\kappa_K = \frac{1}{R_m u_s} \int_{0^-}^{0^+} M u''(x) dx = \frac{M_{pl}}{R_m u_s} \int_{0^-}^{0^+} u''(x) dx \quad (\text{B.40})$$

The integral of the curvature in the hinges is one way to express the change of the angle in this point.

$$\int_{0^-}^{0^+} u''(x) dx = u'(0) = \frac{u_s}{L} \quad (\text{B.41})$$

The maximum internal resistance R_m is equal to the external load needed to create the mechanism, P_{pl} , (or $q_{pl} \cdot L$ for uniformly distributed load) (see

Figure B.3). The moment in the system point is equal to the plastic moment, M_{pl} .

B.3.1 Case (3.1)

For a cantilever beam subjected to a concentrated load (see

Figure B.3.a) the plastic moment is:

$$M_{pl} = P_{pl} L \quad (\text{B.42})$$

Equation (B.37) gives the transformation factor for the internal resisting force for case (3.1).

$$\kappa_p = 1.0000 \quad (\text{B.43})$$

Equation (B.42) and (B.44) inserted in Equation (B.40) gives the transformation factor for the internal resisting force for case (3.1).

$$\kappa_K = \frac{M_{pl}}{R_m u_s} \int_{0^-}^{0^+} u''(x) dx = \frac{P_{pl} L}{R_m u_s} \frac{u_s}{L} = \frac{P_{pl}}{P_{pl}} = 1.0000 \quad (\text{B.44})$$

B.3.2 Case (3.2)

For a beam subjected to a concentrated load (see

Figure B.3.b) the plastic moment is:

$$M_{pl} = \frac{q_{pl} L^2}{2} \quad (\text{B.45})$$

Equation (B.38) gives the transformation factor for the internal resisting force for case (3.2).

$$\kappa_P = \frac{\int_{x=0}^{x=L} \frac{x}{L} q(x, t) dx}{\int_{x=0}^{x=L} q(x, t) dx} = \frac{1}{qL} \int_{x=0}^{x=L} \frac{x}{L} q dx = \frac{1}{2} \quad (\text{B.46})$$

Equation (B.42) and (B.45) inserted in Equation (B.40) gives the transformation factor for the internal resisting force for case (4.2.5).

$$\kappa_K = \frac{M_{pl}}{R_m u_s} \int_{0^-}^{0^+} u''(x) dx = \frac{q_{pl} L^2}{2} \frac{1}{R_m u_s} \frac{u_s}{L} = \frac{1}{2} \frac{q_{pl} L^2}{q_{pl} L^2} = \frac{1}{2} \quad (\text{B.47})$$

APPENDIX C Comparison with transformation factor according to Granström and Balazs

Granström (1958) and Balazs (1997) have used a different definition of the transformation factor for the internal resisting load than used in this report. The definition for the ideal plastic case according to Granström and Balazs (here called $\kappa_K^{G/B}$) is:

$$\kappa_K^{G/B} = \frac{1}{8} \int_{\zeta=0}^{\zeta=1} \frac{M(\zeta)}{M_*} \eta''(\zeta) d\zeta \quad (C.1)$$

where $\zeta = x/L$ relation between coordinate x and the length of the beam

$M(\zeta)$ moment

$\eta(\zeta) = \frac{u(\zeta)}{u_s}$ relation between deflection and the deflection of the system point

M_* moment in section of comparison (often coinciding with the system point)

In order to make it possible to compare the two different expressions for the transformation factor the expression of κ_K in ideal plastic case (see Equation (6.42)) can be rewritten as:

$$\begin{aligned} \kappa_K &= \frac{1}{R_m u_s} \int_{x=0}^{x=L} M(x) u''(x) dx = \frac{1}{R_m u_s} \int_{\zeta=0}^{\zeta=1} M(x) u''(x) d\zeta = \\ &= \left\{ \begin{array}{l} M(x) = M(\zeta)L \\ u''(x) = \eta''(\zeta) u_s / L^2 \end{array} \right\} = \frac{1}{R_m L} \int_{\zeta=0}^{\zeta=1} M(\zeta) \eta''(\zeta) d\zeta \end{aligned} \quad (C.2)$$

The relation between $\kappa_K^{G/B}$ and κ_K is then:

$$\frac{\kappa_K^{G/B}}{\kappa_K} = \frac{\frac{1}{8} \int_{\zeta=0}^{\zeta=1} \frac{M(\zeta)}{M_*} \eta''(\zeta) d\zeta}{\frac{1}{R_m L} \int_{\zeta=0}^{\zeta=1} M(\zeta) \eta''(\zeta) d\zeta} = \frac{LR_m}{8M_*} \quad (C.3)$$

Equation (C.3) can be rewritten as:

$$\kappa_K = \kappa_K^{G/B} \cdot \frac{8M_*}{LR_m} \quad (\text{C.4})$$

The equation of motion used in this report, for a SDOF system with ideal plastic material, is:

$$\kappa_M M \ddot{u}_s + \kappa_K R_m = \kappa_P P(t) \quad (\text{C.5})$$

The differential equation according to Granström (1958) and Balazs (1997) can by use of Equations (C.4) and (C.5) be written as :

$$\kappa_M M \ddot{u}_s + \kappa_K^{G/B} \cdot \frac{8M_*}{L} = \kappa_P P(t) \quad (\text{C.6})$$

APPENDIX D Input data in analyses

The cross-section of the reinforced concrete beam, shown in Figure D.1, is chosen in order to fulfil minimum requirements in the Swedish shelter regulation described in Section 12.3.

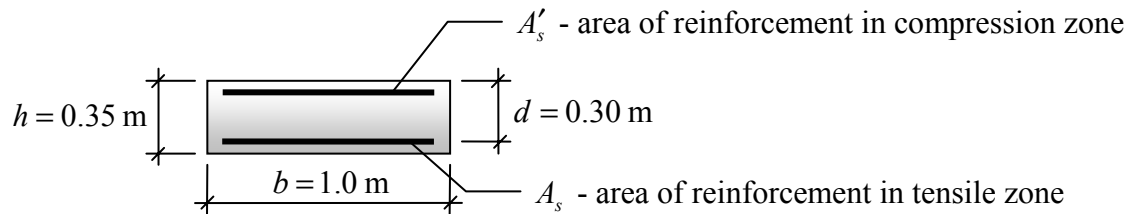

Figure D.1 Cross-section of reinforced concrete beam.

Equation (9.1) gives the limitations of the amount of reinforcement and for this beam the amount of reinforcement close to $\rho = 0.30\%$ are wanted. For this amount the total area of reinforcement A_s is:

$$A_s = \rho \cdot b \cdot d = 900 \text{ mm}^2 \quad (\text{D.1})$$

In order to have even values $\phi 16 \text{ s}200$ is used (meaning reinforcement bars of diameter 16 mm with spacing 200 mm) the total area of reinforcement per meter is:

$$A_s = 1005 \text{ mm}^2/\text{m} \quad (\text{D.2})$$

and by use of Equation (9.1) the amount of reinforcement is calculated.

$$\rho = \frac{A_s}{b \cdot d} = 0.335\% \quad (0.14\% < 0.335\% < 1.1\%) \quad (\text{D.3})$$

The beam is double reinforced (meaning that reinforcement bars are placed both in tensile and compression zone). The area of the tensile steel is chosen to be the same as for the compressed steel.

$$A'_s = 1005 \text{ mm}^2/\text{m} \quad (\text{D.4})$$

The support moment is assumed to be equal to the maximum field moment.

$$M_s = M_f \quad (\text{D.5})$$

The characteristic values of the material properties of interest for concrete C25/30 and reinforcement steel B500B are shown in Table 7.1 and Table D.2 respectively.

Table D.1 Material properties for concrete quality C25/30

C25/30	
Compressive strength, f_{ck}	24 MPa
Tensile strength, f_{ctk}	1.7 MPa
Modulus of elasticity, E_{ck}	31 GPa

Table D.2 Material properties for reinforcement quality B500B

B500B	
Yielding stress, f_{yk}	500 MPa
Modulus of elasticity, E_{sk}	200 GPa

D.1 Moment capacities for the different stadiums

In order to get the material response curve (load-deflection curve) the values of the load when the material cracks P_{cr} , when the reinforcement starts to yield P_{pl} and the ultimate load P_u must be calculated. In case of uniformly distributed load $P_{cr} = q_{cr} \cdot L$, $P_{pl} = q_{pl} \cdot L$ and $P_u = q_u \cdot L$. Due to the Swedish shelter regulations all calculations are preformed in ultimate limit state.

In Section 12.2.2 the relation between the design and characteristic values of the material properties in ultimate limit state for concrete and steel are presented as:

$$f_d = \frac{f_k}{\eta \gamma_m \gamma_n} \quad (\text{D.6})$$

$$E_d = \frac{E_k}{\eta \gamma_m \gamma_n} \quad (\text{D.7})$$

$$f_{st} = 0.9 f_{yk} \quad (\text{D.8})$$

where the values of the safety factors (here meaning $\eta \cdot \gamma_m$ and γ_n) are 1.0 in all cases except when calculating the design value of the strength parameters for concrete, then $\gamma_m \eta$ equals 1.2. The compression strength and the modulus of elasticity of the

concrete are multiplied with a factor 1.1 and 1.2 respectively in case of accidental and dynamic load.

$$f_{ccd}^{accidental} = 1.1 f_{ccd} \quad (D.9)$$

$$E_{cd}^{dynamic} = \frac{1.2 \cdot E_{ck}}{\eta \gamma_m \gamma_n} \quad (D.10)$$

- Concrete C25/30:

$$f_{ccd} = 1.1 \left(\frac{f_{cck}}{1.2} \right) = 1.1 \left(\frac{24}{1.2} \right) = 22 \text{ MPa}$$

$$f_{ctd} = \frac{f_{ctk}}{1.2} = 1.417 \text{ MPa}$$

$$E_{cd} = 1.2 E_{ck} = 37.2 \text{ GPa}$$

- Reinforcing steel B500B:

$$f_{st} = 0.9 \cdot f_{yk} = 0.9 \cdot 500 = 450 \text{ MPa}$$

$$E_{sd} = E_{sk} = 200 \text{ GPa}$$

The factor α is defined in Equation (12.13) and is in this case: $\alpha = \frac{200}{37.2} = 5.38$

D.1.1 Stadium I

Due to the crack criteria in Section 12.2.1.4 the beam remains uncracked as long as the maximum value of the tensile stress in the most exposed cross-section fulfils

$$\sigma_{ct} < \frac{f_{cbt}}{\zeta} \quad (D.11)$$

meaning that the cross-section cracks when:

$$\sigma_{ct,max} = \frac{f_{cbt}}{\zeta} \quad (D.12)$$

where ζ is 1.0 and the flexural strength is calculated as:

$$f_{cbt} = k \cdot f_{ct} \quad (D.13)$$

$$k = 0.6 + \frac{0.4}{\sqrt[4]{h}} \quad \text{and} \quad 1.0 \leq k \leq 1.45$$

Applied on this example the value of the flexural strength is:

$$k = 0.6 + \frac{0.4}{\sqrt[4]{0.35}} = 1.12 \quad (\text{D.14})$$

$$f_{cbt} = 1.12 \cdot 1.417 = 1.59 \text{ MPa}$$

By use of Equation (D.12) the value of the tensile stress when the cross-section cracks can be calculated.

$$\sigma_{ct,max} = \frac{f_{cbt}}{\zeta} = \frac{1.59}{1.0} = 1.59 \text{ MPa} \quad (\text{D.15})$$

The equivalent area for a cross-section in stadium I is calculated as in Equation (12.12) and for a rectangular cross-section with reinforcement in the compressed zone the equation can be written and calculated as:

$$A_I = b \cdot h + (\alpha - 1)A'_s + (\alpha - 1)A_s =$$

$$= 0.35 + (5.38 - 1) \cdot 1005 \cdot 10^{-6} + (5.38 - 1) \cdot 1005 \cdot 10^{-6} = \quad (\text{D.16})$$

$$= 0.359 \text{ m}^2$$

The distance to the centre of gravity, measured from the most compressed edge of the cross-section is, due to symmetry:

$$x_{CG} = \frac{h}{2} = \frac{0.35}{2} = 0.175 \text{ m} \quad (\text{D.17})$$

The moment of inertia for the rectangular cross-section is calculated by means of Equation (12.23).

$$I_I = \frac{bh^3}{12} + (\alpha - 1)A_s(x_{CG} - d')^2 + (\alpha - 1)A_s(d - x_{CG})^2 =$$

$$= \frac{0.35^3}{12} + (5.38 - 1) \cdot 1005 \cdot 10^{-6} (0.175 - 0.05)^2 + \quad (\text{D.18})$$

$$(5.38 - 1) \cdot 1005 \cdot 10^{-6} (0.3 - 0.175)^2 =$$

$$= 3.71 \cdot 10^{-3} \text{ m}^4$$

By rearranging the terms in Equation (12.22) and using the concrete stress in the tensioned edge for which the cross-section cracks $\sigma_{ct,max}$ (see Equation (D.15)) the

moment for which the cross-section cracks M_{cr} can be calculated. The distance z from the neutral layer to the tensioned edge is $z = h - x_{CG}$.

$$M_{cr} = \frac{\sigma_{ct,max} \cdot I_I}{z} = \frac{1.59 \cdot 10^6 \cdot 3.71 \cdot 10^{-3}}{0.35 - 0.175} =$$

$$= 33.64 \text{ kNm} \quad (\text{D.19})$$

The load for which the cross-section cracks can now easily be calculated, however, the expressions depend on boundary conditions and type of load.

D.1.2 Stadium II

Once the beam has cracked the calculations is made in stadium II as long as no yielding take place in the material.

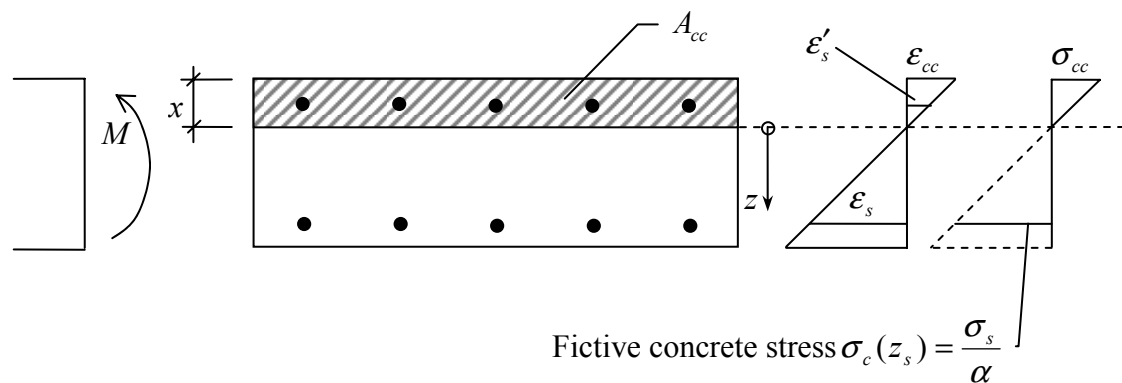

Figure D.2 Strain and stress distribution in cracked rectangular cross-section of reinforced concrete subjected to pure bending.

For cross-section subjected to pure bending the neutral layer coincides with the centre of gravity of the equivalent cross-section.

$$x = x_{CG} \quad (\text{D.20})$$

By use of Equation (12.28) the distance from the most compressed edge to the neutral layer is calculated.

$$\begin{aligned}
& x^2 + \frac{2}{b}((\alpha - 1)A'_s + \alpha A_s)x - \frac{2}{b}((\alpha - 1)A'_s \cdot d' + \alpha A_s \cdot d) \\
& \Rightarrow \\
& x = -\frac{(\alpha - 1)A'_s + \alpha A_s}{b} + \\
& \quad \sqrt{\left(\frac{(\alpha - 1)A'_s + \alpha A_s}{b}\right)^2 + \frac{2}{b}((\alpha - 1)A'_s \cdot d' + \alpha A_s \cdot d)} = \\
& = -\frac{(5.38 - 1) \cdot 1005 \cdot 10^{-6} + 5.38 \cdot 1005 \cdot 10^{-6}}{1.0} + \\
& \quad \sqrt{\left(\frac{(5.38 - 1) \cdot 1005 \cdot 10^{-6} + 5.38 \cdot 1005 \cdot 10^{-6}}{1.0}\right)^2 +} \\
& \quad \frac{2 \cdot 1005 \cdot 10^{-6}}{1.0}((5.38 - 1) \cdot 0.05 + 5.38 \cdot 0.3)} = \\
& = 0.0517 \text{ m}
\end{aligned} \tag{D.21}$$

The equivalent area of the cracked cross-section is calculated by means of Equation (12.14).

$$\begin{aligned}
A_{II} &= A_{cc} + (\alpha - 1)A'_s + \alpha A_s = b \cdot x + (\alpha - 1)A'_s + \alpha A_s = \\
& = 1.0 \cdot 0.0517 + (5.38 - 1) \cdot 1005 \cdot 10^{-6} + \\
& \quad 5.38 \cdot 1005 \cdot 10^{-6} = 0.0615 \text{ m}^2
\end{aligned} \tag{D.22}$$

By use of Equation (12.29) the moment of inertia for the cracked cross-section is calculated.

$$\begin{aligned}
I_{II} &= \frac{bx^3}{3} + (\alpha - 1)A'_s(x - d')^2 + \alpha A_s(d - x)^2 = \\
& = \frac{0.0517^3}{3} + (5.38 - 1) \cdot 1005 \cdot 10^{-6} (0.0517 - 0.05)^2 + \\
& \quad 5.38 \cdot 1005 \cdot 10^{-6} (0.3 - 0.0517)^2 = \\
& = 3.79 \cdot 10^{-4} \text{ m}^4
\end{aligned} \tag{D.23}$$

It is assumed that the steel will start to yield before concrete does (always assumed even though it might not be true). When the yielding starts in the reinforcement bars the stress in the steel is equal to the yield stress.

$$\sigma_s = f_{st} \tag{D.24}$$

the concrete is correct.

By use of Equation (12.31) the fictive concrete stress at the steel level, $\sigma_c(z_s)$, when the reinforcement starts to yield can be calculated.

$$\sigma_c(z_s) = \frac{\sigma_{sy}}{\alpha} = \frac{f_{st}}{\alpha} = \frac{450 \cdot 10^6}{5.38} = 83.7 \text{ MPa} \quad (\text{D.25})$$

By rearranging the terms in Equation (12.19) and using the concrete stress at the steel level when the steel starts to yield (see Equation (D.25)) the moment for which the yielding starts M_{spl} can be calculated. The distance z_s from the neutral layer to the steel level is $z_s = d - x_{CG}$.

$$\begin{aligned} M_{spl} &= \frac{\sigma_c(z_s) \cdot I_{II}}{z_s} = \frac{83.7 \cdot 10^6 \cdot 3.79 \cdot 10^{-4}}{0.3 - 0.0517} = \\ &= 127.8 \text{ kNm} \end{aligned} \quad (\text{D.26})$$

The load for which the steel starts to yield can now easily be calculated, however, the expressions depend on boundary conditions and type of load. For a beam subjected to

D.1.3 Stadium III

The stress and strain distributions, when using simplified stress block, in the cross-section for stadium III are shown in Figure D.3 where α and β are 0.8 and 0.4 respectively.

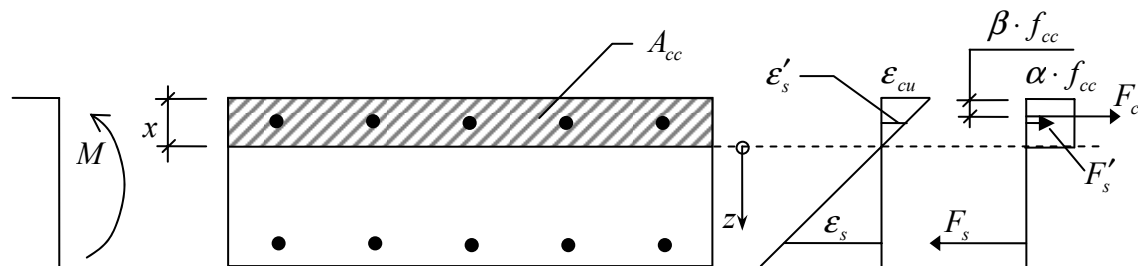

Figure D.3 Strain and stress distribution in cracked rectangular cross-section of reinforced concrete subjected to pure bending and where the maximum value of the concrete strain in the compressed edge is reached. (When using simplified stress block).

The tensile steel is assumed to have a plastic behaviour when the ultimate state is reached meaning that the strain in the steel ϵ_s is higher than the value of the strain when yielding starts ϵ_{sy} :

$$\epsilon_s \geq \epsilon_{sy} \quad (\text{D.27})$$

As soon as the value of the strain when yielding starts ε_{sy} is reached in the reinforcement bars the stress in the bars σ_s is equal to the yield stress f_{st} :

$$\sigma_s = f_{st} \quad (D.28)$$

By means of Hook's law the force F_s in the steel is calculated as:

$$F_s = f_{st} \cdot A_s = 450 \cdot 10^6 \cdot 1005 \cdot 10^{-6} = 452.25 \text{ kN} \quad (D.29)$$

The reinforcement in the compressed zone is assumed not to yield and has therefore elastic behaviour.

$$\sigma'_s = E_s \cdot \varepsilon'_s \quad (D.30)$$

Where the strain in the compressed steel ε'_s is calculated in the same way as ε_s in Equation (12.32). The ultimate concrete strain ε_{cu} is reached in the compressed edge.

$$\varepsilon'_s = \frac{(x - d')}{x} \varepsilon_{cu} \quad (D.31)$$

By means of Hook's law the force F'_s in the steel is calculated as:

$$\begin{aligned} F'_s &= \sigma'_s \cdot A'_s = E_s \cdot \varepsilon'_s \cdot A'_s = E_s \cdot \frac{(x - d')}{x} \varepsilon_{cu} \cdot A'_s = \\ &= 200 \cdot 10^9 \frac{(x - 0.05)}{x} 3.5 \cdot 10^{-3} \cdot 1005 \cdot 10^{-6} = \\ &= 703.5 - \frac{35.175}{x} \text{ kN} \end{aligned} \quad (D.32)$$

The resulting force in the compressed concrete is calculated by use of Equation (12.38).

$$F_c = f_{cc} \cdot b \cdot \alpha \cdot x = 22 \cdot 10^6 \cdot 1.0 \cdot 0.8x = 17600 \cdot x \text{ kN} \quad (D.33)$$

Horizontal equilibrium conditions gives:

$$\begin{aligned} F_c + F'_s &= F_s \\ 17600x + 703.5 - \frac{35.175}{x} &= 452.25 \\ 17600x^2 + (703.5 - 452.25)x - 35.175 &= 0 \\ x &= -\frac{251.25}{2 \cdot 17600} + \sqrt{\left(\frac{251.25}{2 \cdot 17600}\right)^2 + \frac{35.175}{17600}} = 0.0381 \text{ m} \end{aligned} \quad (D.34)$$

Now control that the assumptions made in Equations (D.28) and (D.30) are correct.

The ultimate strain of concrete is $\varepsilon_{cu} = 3.5 \cdot 10^{-3}$ and the steel strains are calculated by use of Equation (12.37).

$$\varepsilon_s = \frac{d-x}{x} \varepsilon_{cu} = \frac{0.3-0.0381}{0.0381} \cdot 3.5 \cdot 10^{-3} = 24.0 \text{ ‰} \quad (\text{D.35})$$

$$\varepsilon'_s = \frac{x-d'}{x} \varepsilon_{cu} = \frac{0.0381-0.05}{0.0381} \cdot 3.5 \cdot 10^{-3} = -1.09 \text{ ‰} \quad (\text{D.36})$$

The yield strain in the steel is:

$$\varepsilon_{sy} = \frac{\sigma_y}{E_s} = \frac{f_{st}}{E_s} = \frac{450 \cdot 10^6}{200 \cdot 10^9} = 2.25 \text{ ‰} \quad (\text{D.37})$$

and it is seen that the assumptions made are correct.

By means of a moment equation about x , as in Equation (12.41), gives the value of the ultimate moment capacity of the beam.

$$\begin{aligned} M_{pl} &= 0.8 f_{cc} \cdot b \cdot x(d - 0.4x) + \varepsilon'_s \cdot E_s \cdot A_s (d - d') = \\ &= 0.8 \cdot 22 \cdot 10^6 \cdot 1.0 \cdot 0.0381 \cdot (0.3 - 0.4 \cdot 0.0381) + \\ &\quad (-1.09 \cdot 10^{-3}) \cdot 200 \cdot 10^9 \cdot 1005 \cdot 10^{-6} (0.3 - 0.05) = \\ &= 136.4 \text{ kNm} \end{aligned} \quad (\text{D.38})$$

D.2 Load-displacement relations

D.2.1 Case(1.1)

In stadium I and II a reinforced concrete beam behaves elastically and the maximum moment appears, in this case, in the middle of the beam and is calculated as:

$$M = \frac{PL}{4} \Leftrightarrow P = \frac{4M}{L} \quad (\text{D.39})$$

The load for which the first crack occurs is then:

$$P_{cr} = \frac{4M_{cr}}{L} = \frac{4 \cdot 33.64}{2.5} = 53.8 \text{ kN} \quad (\text{D.40})$$

The reinforcement in the tensile zone starts to yield when the load is:

$$P_{spl} = \frac{4M_{spl}}{L} = \frac{4 \cdot 127.8}{2.5} = 204.5 \text{ kN} \quad (\text{D.41})$$

When having elastic response the stiffness K can be calculated as:

$$K = \frac{48EI}{L^3} \quad (\text{D.42})$$

In stadium I the stiffness is:

$$K_I = \frac{48E_c I_I}{L^3} = \frac{48 \cdot 37.2 \cdot 10^9 \cdot 3.71 \cdot 10^{-3}}{2.5^3} = 424.0 \text{ MN/m} \quad (\text{D.43})$$

Just before yielding starts in the reinforcing steel in the tensile zone the stiffness is:

$$K_{II} = \frac{48E_c I_{II}}{L^3} = \frac{48 \cdot 37.2 \cdot 10^9 \cdot 3.79 \cdot 10^{-4}}{2.5^3} = 43.3 \text{ MN/m} \quad (\text{D.44})$$

The values of the midpoint deflection corresponding to P_{cr} and P_{pl} is calculated as:

$$u = \frac{P}{K} \quad (\text{D.45})$$

The midpoint deflection is than for load P_{cr} :

$$u_{cr} = \frac{P_{cr}}{K_I} = \frac{53.8 \cdot 10^3}{424.0 \cdot 10^6} = 0.127 \text{ mm} \quad (\text{D.46})$$

and the midpoint deflection for load P_{pl} is:

$$u_{spl} = \frac{P_{spl}}{K_{II}} = \frac{204.5 \cdot 10^3}{43.3 \cdot 10^6} = 4.72 \text{ mm} \quad (\text{D.47})$$

The inclination of the load-displacement curve in between the occurrence of the first crack and the ultimate state is calculated as:

$$K' = \frac{P_{spl} - P_{cr}}{u_{spl} - u_{cr}} = \frac{(204.5 - 53.8) \cdot 10^3}{(4.72 - 0.127) \cdot 10^{-3}} = 32.8 \text{ MN/m} \quad (\text{D.48})$$

In stadium III, the ultimate state, the beam is a mechanism and for a simply supported beam a plastic hinge is formed in the middle of the beam. The ultimate force is calculated as:

$$P_{pl} = \frac{4M_{pl}}{L} = \frac{4 \cdot 136.4}{2.5} = 218.2 \text{ kN} \quad (\text{D.49})$$

The relation between the load and displacement is shown graphically in Figure D.4.

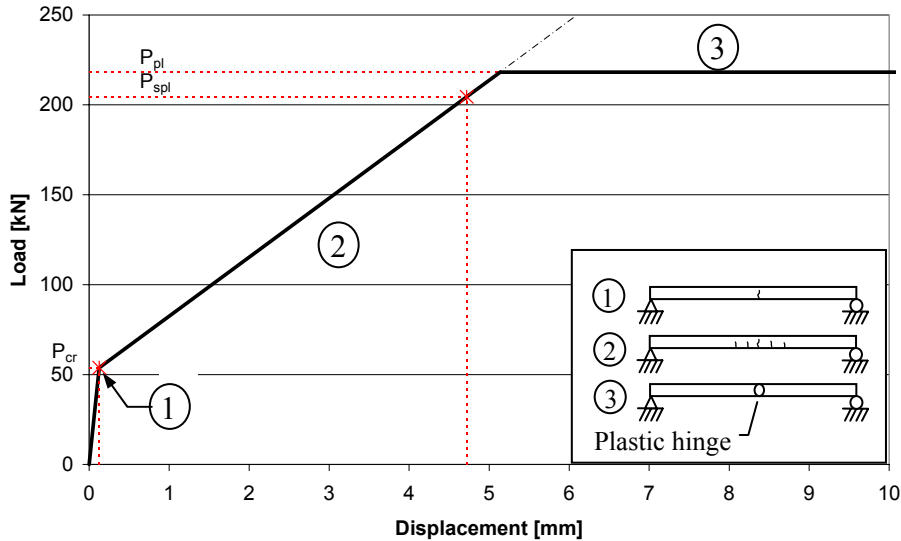

Figure D.4 Relation between load and displacement for case(1.1).

D.2.2 Case(1.2)

In stadium I and II a reinforced concrete beam behaves elastically and the maximum moment appears, in this case, in the middle of the beam and is calculated as:

$$M = \frac{qL^2}{8} = \frac{PL}{8} \Leftrightarrow P = \frac{8M}{L} \quad (\text{D.50})$$

The load for which the first crack occurs is then:

$$P_{cr} = \frac{8M_{cr}}{L} = \frac{8 \cdot 33.64}{2.5} = 107.7 \text{ kN} \quad (\text{D.51})$$

The reinforcement in the tensile zone starts to yield when the load is:

$$P_{spl} = \frac{8M_{spl}}{L} = \frac{8 \cdot 127.8}{2.5} = 409.0 \text{ kN} \quad (\text{D.52})$$

When having elastic response the stiffness K can be calculated as:

$$K = \frac{384EI}{5L^3} \quad (\text{D.53})$$

In stadium I the stiffness is:

$$K_I = \frac{384E_c I_I}{5L^3} = \frac{384 \cdot 37.2 \cdot 10^9 \cdot 3.71 \cdot 10^{-3}}{5 \cdot 2.5^3} = 678.4 \text{ MN/m} \quad (\text{D.54})$$

Just before yielding starts in the reinforcing steel in the tensile zone the stiffness is:

$$K_{II} = \frac{384E_c I_{II}}{5L^3} = \frac{384 \cdot 37.2 \cdot 10^9 \cdot 3.79 \cdot 10^{-4}}{5 \cdot 2.5^3} = 69.3 \text{ MN/m} \quad (\text{D.55})$$

The values of the midpoint deflection corresponding to P_{cr} and P_{pl} is calculated as:

$$u = \frac{P}{K} \quad (\text{D.56})$$

The midpoint deflection is than for load P_{cr} :

$$u_{cr} = \frac{P_{cr}}{K_I} = \frac{107.7 \cdot 10^3}{678.4 \cdot 10^6} = 0.159 \text{ mm} \quad (\text{D.57})$$

and the midpoint deflection for load P_{spl} is:

$$u_{spl} = \frac{P_{spl}}{K_{II}} = \frac{409.0 \cdot 10^3}{69.3 \cdot 10^6} = 5.90 \text{ mm} \quad (\text{D.58})$$

The inclination of the load-displacement curve in between the occurrence of the first crack and the ultimate state is calculated as:

$$K' = \frac{P_{spl} - P_{cr}}{u_{spl} - u_{cr}} = \frac{(409.0 - 107.7) \cdot 10^3}{(5.90 - 0.159) \cdot 10^{-3}} = 52.5 \text{ MN/m} \quad (\text{D.59})$$

In stadium III, the ultimate state, the beam is a mechanism and for a simply supported beam a plastic hinge is formed in the middle of the beam. The ultimate force is calculated as:

$$P_{pl} = \frac{8M_{pl}}{L} = \frac{8 \cdot 136.4}{2.5} = 436.4 \text{ kN} \quad (\text{D.60})$$

The relation between the load and displacement is shown graphically in Figure D.5.

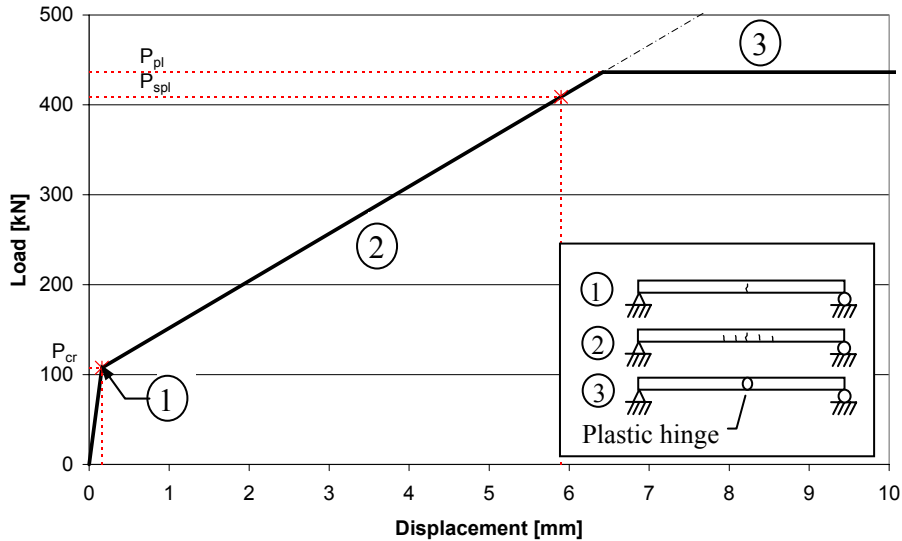

Figure D.5 Relation between load and displacement for case(1.2).

D.2.3 Case(2.1)

In stadium I and II a reinforced concrete beam behaves elastically and the maximum moment appears, in this case, at the supports and in the middle of the beam at the same time and is calculated as:

$$M = \frac{PL}{8} \Leftrightarrow P = \frac{8M}{L} \quad (\text{D.61})$$

The load for which the first crack occurs is then:

$$P_{cr} = \frac{8M_{cr}}{L} = \frac{8 \cdot 33.64}{2.5} = 107.7 \text{ kN} \quad (\text{D.62})$$

The reinforcement in the tensile zone starts to yield when the load is:

$$P_{spl} = \frac{8M_{spl}}{L} = \frac{8 \cdot 127.8}{2.5} = 409.0 \text{ kN} \quad (\text{D.63})$$

When having elastic response the stiffness K can be calculated as (Samuelsson, Wiberg (1999):

$$K = \frac{192EI}{L^3} \quad (\text{D.64})$$

In stadium I the stiffness is:

$$K_I = \frac{192E_c I_I}{L^3} = \frac{192 \cdot 37.2 \cdot 10^9 \cdot 3.71 \cdot 10^{-3}}{2.5^3} = 1696.1 \text{ MN/m} \quad (\text{D.65})$$

Just before yielding starts in the reinforcing steel in the tensile zone the stiffness is:

$$K_{II} = \frac{192E_c I_{II}}{L^3} = \frac{192 \cdot 37.2 \cdot 10^9 \cdot 3.79 \cdot 10^{-4}}{2.5^3} = 173.3 \text{ MN/m} \quad (\text{D.66})$$

The values of the midpoint deflection corresponding to P_{cr} and P_{pl} is calculated as:

$$u = \frac{P}{K} \quad (\text{D.67})$$

The midpoint deflection is than for load P_{cr} :

$$u_{cr} = \frac{P_{cr}}{K_I} = \frac{107.7 \cdot 10^3}{1696.1 \cdot 10^6} = 0.0635 \text{ mm} \quad (\text{D.68})$$

and the midpoint deflection for load P_{spl} is:

$$u_{spl} = \frac{P_{spl}}{K_{II}} = \frac{409.0 \cdot 10^3}{173.3 \cdot 10^6} = 2.36 \text{ mm} \quad (\text{D.69})$$

The inclination of the load-displacement curve in between the occurrence of the first crack and the ultimate state is calculated as:

$$K' = \frac{P_{spl} - P_{cr}}{u_{spl} - u_{cr}} = \frac{(409.0 - 107.7) \cdot 10^3}{(2.36 - 0.0635) \cdot 10^{-3}} = 131.2 \text{ MN/m} \quad (\text{D.70})$$

In stadium III, the ultimate state, the beam is a mechanism and for a fixed beam plastic hinge are formed at the supports and in the middle of the beam. The ultimate force is calculated as:

$$P_{pl} = \frac{8M_{pl}}{L} = \frac{8 \cdot 136.4}{2.5} = 436.4 \text{ kN} \quad (\text{D.71})$$

The relation between the load and displacement is shown graphically in Figure D.6.

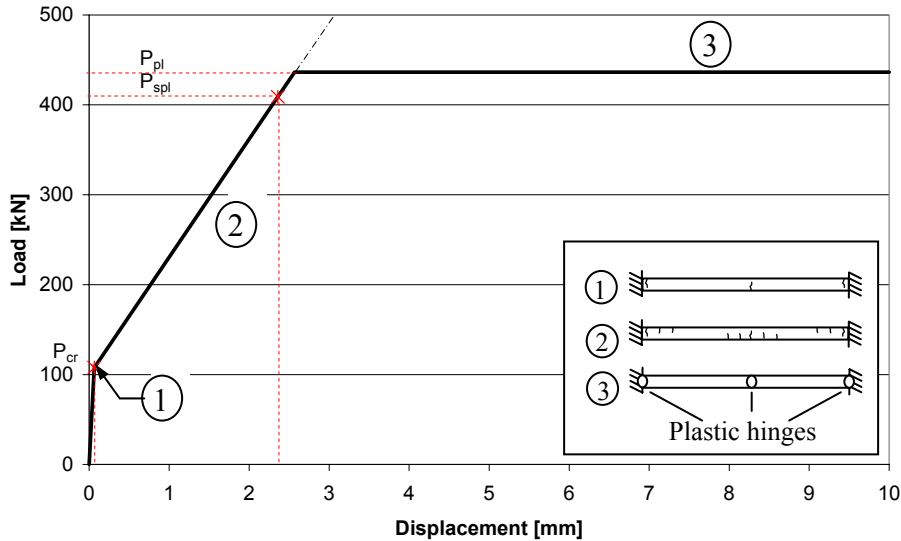

Figure D.6 Relation between load and displacement for case(2.1).

D.2.4 Case(2.2)

In stadium I and II a reinforced concrete beam behaves elastically and the maximum moment appears, in this case, at the supports and is calculated as:

$$M = \frac{qL^2}{12} = \frac{PL}{12} \Leftrightarrow P = \frac{12M}{L} \quad (\text{D.72})$$

The load for which the first crack occurs is then:

$$P_{cr} = \frac{12M_{cr}}{L} = \frac{12 \cdot 33.64}{2.5} = 161.5 \text{ kN} \quad (\text{D.73})$$

The reinforcement in the tensile zone starts to yield when the load is:

$$P_{spl} = \frac{12M_{spl}}{L} = \frac{12 \cdot 127.8}{2.5} = 613.5 \text{ kN} \quad (\text{D.74})$$

When having elastic response the stiffness K can be calculated as:

$$K = \frac{384EI}{L^3} \quad (\text{D.75})$$

In stadium I the stiffness is:

$$K_I = \frac{384E_c I_I}{L^3} = \frac{384 \cdot 37.2 \cdot 10^9 \cdot 3.71 \cdot 10^{-3}}{2.5^3} = 3392 \text{ MN/m} \quad (\text{D.76})$$

Just before yielding starts in the reinforcing steel in the tensile zone the stiffness is:

$$K_{II} = \frac{384E_c I_{II}}{L^3} = \frac{384 \cdot 37.2 \cdot 10^9 \cdot 3.79 \cdot 10^{-4}}{2.5^3} = 346.7 \text{ MN/m} \quad (\text{D.77})$$

The values of the midpoint deflection corresponding to P_{cr} and P_{pl} is calculated as:

$$u = \frac{P}{K} \quad (\text{D.78})$$

The midpoint deflection is than for load P_{cr} :

$$u_{cr} = \frac{P_{cr}}{K_I} = \frac{161.5 \cdot 10^3}{3392 \cdot 10^6} = 0.0476 \text{ mm} \quad (\text{D.79})$$

and the midpoint deflection for load P_{spl} is:

$$u_{spl} = \frac{P_{spl}}{K_{II}} = \frac{613.5 \cdot 10^3}{346.7 \cdot 10^6} = 1.77 \text{ mm} \quad (\text{D.80})$$

The inclination of the load-displacement curve in between the occurrence of the first crack and the ultimate state is calculated as:

$$K' = \frac{P_{spl} - P_{cr}}{u_{spl} - u_{cr}} = \frac{(613.5 - 161.5) \cdot 10^3}{(1.77 - 0.0476) \cdot 10^{-3}} = 262.5 \text{ MN/m} \quad (\text{D.81})$$

In stadium III, the ultimate state, the beam is a mechanism and for a fixed beam plastic hinge are formed at the supports and in the middle of the beam. The ultimate force is calculated as:

$$P_{pl} = \frac{16M_{pl}}{L} = \frac{16 \cdot 136.4}{2.5} = 872.9 \text{ kN} \quad (\text{D.82})$$

The relation between the load and displacement is shown graphically in Figure D.7.

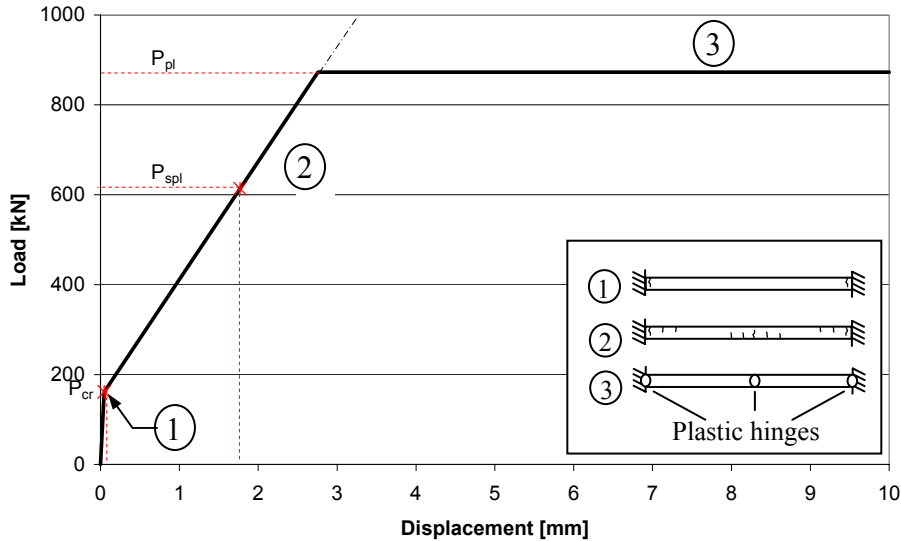

Figure D.7 Relation between load and displacement for case(2.2).

D.3 Stress-strain relation

The material properties used as input in ADINA (2004) is the relation between the stress and strain why these have to be calculated from the relations between load and displacement in Section 7.1.1. It shall be observed that the method used here to calculate the stress-strain relation corresponding to the load-displacement relation is an approximate method. A static analyses made in ADINA (2004) will probably not give a load-displacement curve equal to the one used when calculating the stress-strain relation. In order to verify that the method used here give useful results a comparison between the load-displacement curve used when calculating the stress-strain relation and the resulting load-displacement curve from a static analyses made in ADINA (2004) is made for each case.

Since the beam used in the FE analysis has a constant cross-section through the whole analysis while the cross-section of the reinforced concrete will change the stresses corresponding to the crack moment M_{cr} , moment where yielding starts M_{spl} and the ultimate moment M_{pl} are calculated as shown in Figure D.8. In the SDOF- and FE analysis the cross-section in Figure 7.2 is used and the moment of inertia is:

$$I^{analysis} = I = \frac{bh^3}{12} = \frac{1.0 \cdot 0.35^3}{12} = 3.57 \cdot 10^{-3} \text{ m}^4 \quad (\text{D.83})$$

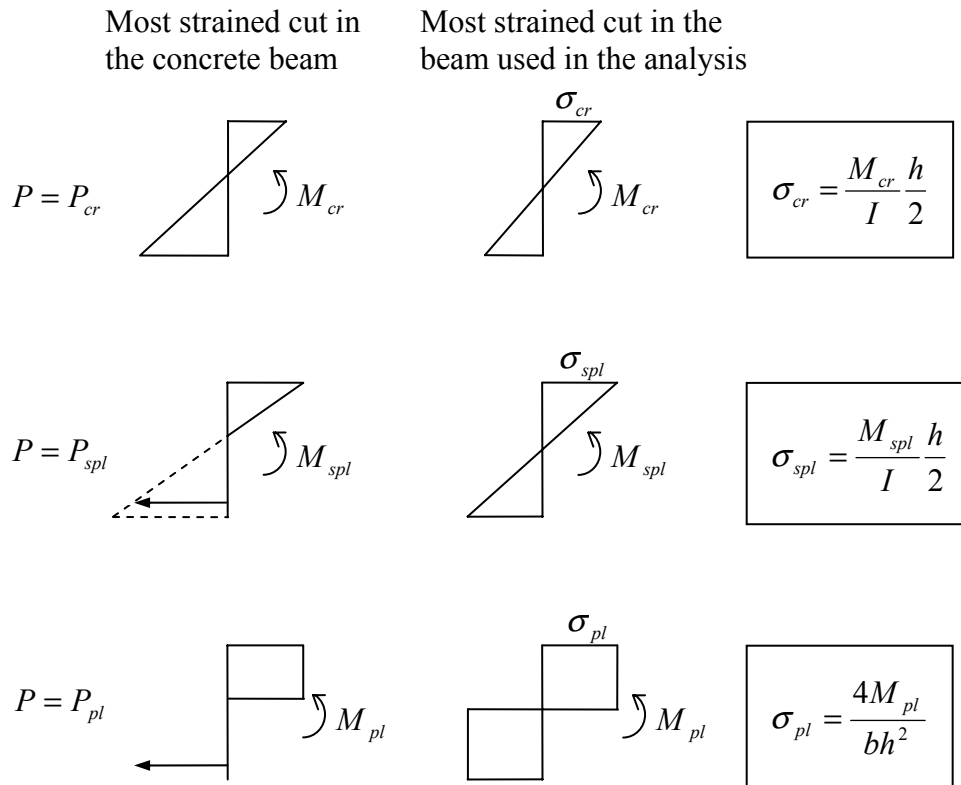

Figure D.8 Stresses for the cross-section used in the analysis.

$$\sigma_{cr}^{analysis} = \frac{12M_{cr}}{bh^3} \frac{h}{2} = \frac{M_{cr}}{bh^2} 6 = \frac{33.64 \cdot 10^3}{1.0 \cdot 0.35^2} 6 = 1.65 \text{ MPa} \quad (D.84)$$

$$\sigma_{spl}^{analysis} = \frac{12M_{spl}}{bh^3} 12 \frac{h}{2} = \frac{M_{spl}}{bh^2} 6 = \frac{127.8 \cdot 10^3}{1.0 \cdot 0.35^2} 6 = 6.26 \text{ MPa} \quad (D.85)$$

$$\sigma_{pl}^{analysis} = \frac{4M_{pl}}{bh^2} = \frac{4 \cdot 136.4 \cdot 10^3}{1.0 \cdot 0.35^2} = 4.45 \text{ MPa} \quad (D.86)$$

Since the value of the ultimate stress σ_{pl} is lower than the value of σ_{spl} the value of σ_{pl} is used as the maximum stress in the FE analysis.

For the reinforced concrete beam the moment of inertia will change as soon as the first crack occurs ($P=P_{cr}$). The relation between the load and the displacement for a simply supported, reinforced concrete beam is principally shown in Figure D.9 and the stiffness K_1 and K_2 are expressed as (according to Samuelsson and Wiberg (1999)):

$$K_1 = \frac{384E_c I_1}{5L^3} \quad (D.87)$$

$$K_2 = \frac{384E_c I_{II}}{5L^3} \quad (D.88)$$

where I_I and I_{II} are equivalent values of the moment of inertia for the reinforced cross-section, for further information see Section 12.2.1.3. E_c is the modulus of elasticity of the concrete.

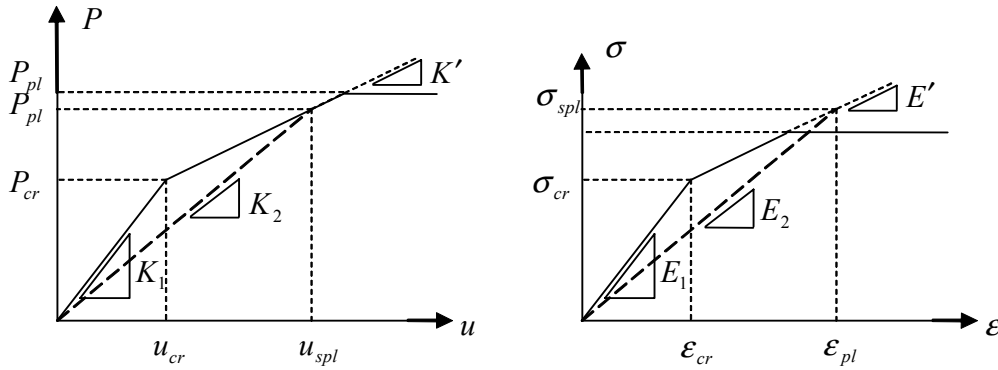

Figure D.9 Notations for material properties for load-displacement relation and stress-strain relation respectively

The corresponding stiffness in the SDOF- and FE-analyses (with moment of inertia in Equation (D.88)) is:

$$K_1^{analysis} = \frac{384E_1 I}{5L^3} \quad (D.89)$$

$$K_2^{analysis} = \frac{384E_2 I}{5L^3} \quad (D.90)$$

The stiffness in the analyses must be equal to the stiffness of the beam and Equation (D.87) shall be equal to Equation (D.89) and Equation (D.88) shall be equal to Equation (D.90).

$$\frac{384E_1 I}{5L^3} = \frac{384E_c I_I}{5L^3} \Rightarrow E_1 = E_c \frac{I_I}{I} \quad (D.91)$$

$$\frac{384E_2 I}{5L^3} = \frac{384E_c I_{II}}{5L^3} \Rightarrow E_2 = E_c \frac{I_{II}}{I} \quad (D.92)$$

The moment of inertia in stadium I and II and the modulus of elasticity for the reinforced concrete beam is calculated in Appendix D and the modulus of elasticity for the analysis can be calculated as:

$$E_1 = E_c \frac{I_I}{I} = 37.2 \cdot 10^9 \frac{3.71 \cdot 10^{-3}}{3.57 \cdot 10^{-3}} = 38.6 \text{ GPa} \quad (D.93)$$

$$E_2 = E_c \frac{I_{II}}{I} = 37.2 \cdot 10^9 \frac{3.79 \cdot 10^{-4}}{3.57 \cdot 10^{-3}} = 3.95 \text{ GPa} \quad (\text{D.94})$$

The strains corresponding to σ_{cr} and σ_{pl} is calculated as:

$$\varepsilon_{cr}^{analysis} = \varepsilon_{cr} = \frac{\sigma_{cr}}{E_1} = \frac{1.65 \cdot 10^6}{38.6 \cdot 10^9} = 0.043 \text{ ‰} \quad (\text{D.95})$$

$$\varepsilon_{spl}^{analysis} = \varepsilon_{spl} = \frac{\sigma_{spl}}{E_2} = \frac{6.26 \cdot 10^6}{3.95 \cdot 10^9} = 1.6 \text{ ‰} \quad (\text{D.96})$$

The inclination of the stress-strain curve in between σ_{cr} and σ_{pl} is:

$$E' = \frac{\sigma_{spl} - \sigma_{cr}}{\varepsilon_{spl} - \varepsilon_{cr}} = \frac{(6.26 - 1.65) \cdot 10^6}{(1.6 - 0.043) \cdot 10^{-3}} = 2.99 \text{ GPa} \quad (\text{D.97})$$

The strain corresponding to the ultimate stress σ_{pl} can be calculated as:

$$\begin{aligned} \varepsilon_{pl}^{analysis} = \varepsilon_u &= \varepsilon_{cr} + \frac{\sigma_u - \sigma_{cr}}{E'} = \\ &= 0.043 \cdot 10^{-3} + \frac{(4.45 - 1.65) \cdot 10^6}{2.99 \cdot 10^9} = 0.98 \text{ ‰} \end{aligned} \quad (\text{D.98})$$

In Figure D.10 the input stress-strain relation used in ADINA (2004) is shown graphically.

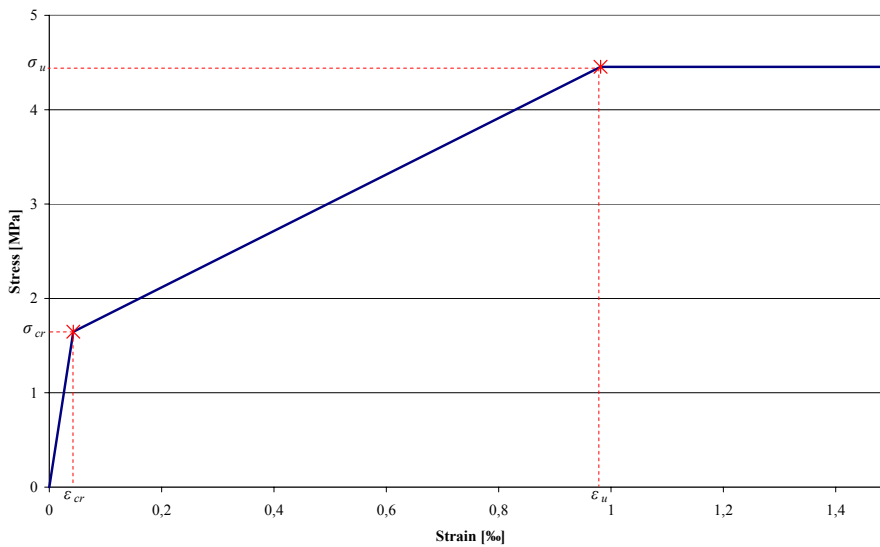

Figure D.10 Stress-strain relation used as input in FE analysis (ADINA (2004)), in figure σ_u represents the value of σ_{pl} .

The resulting load-displacement relation found in static analyses for each beam and loading case are presented in Figure D.11.

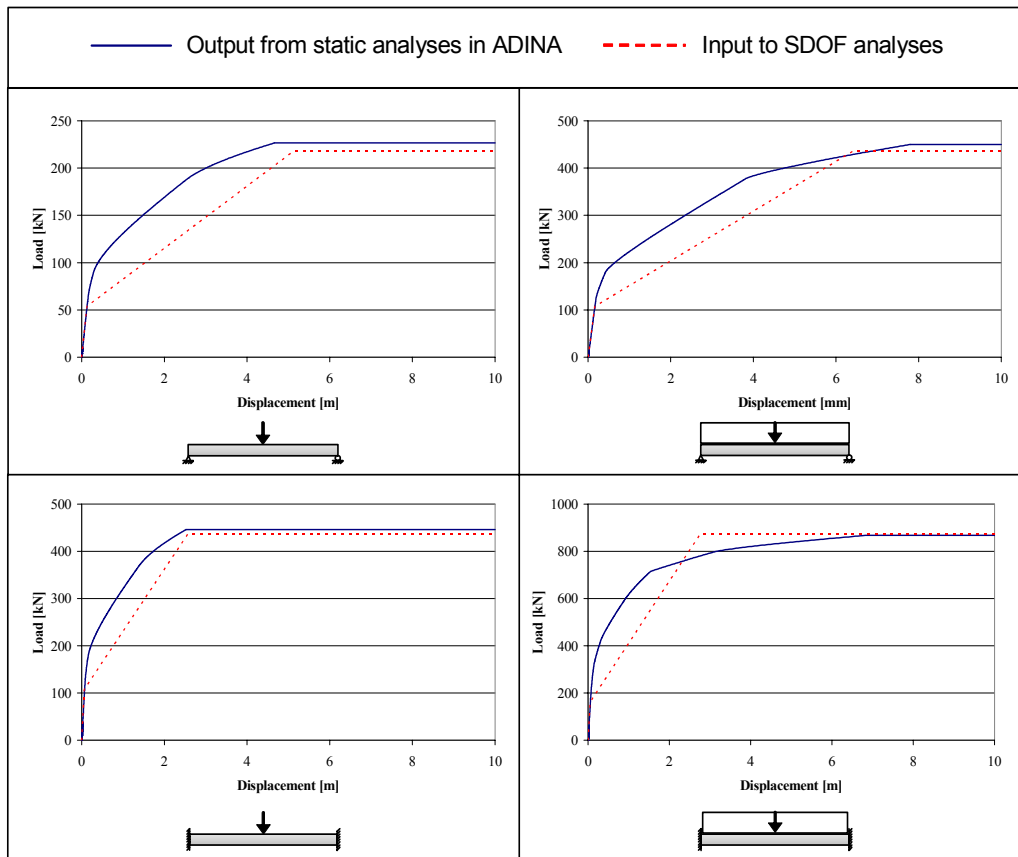

Figure D.11 Relations between load and displacements for SDOF and FE analysis.

The load-displacement curves used in the FE analysis have a more stiff behaviour than the load-displacement curves used in the SDOF analysis. However, the approximated values of the stress-strain relation used as input in the FE analysis are assumed to be good enough.

APPENDIX E Varying number of elements and size of modulus of elasticity in FE-analyses

In order to confirm that the number of elements used are enough and that the modulus of elasticity is high enough in case of ideal plastic material different numbers and values are used in the FE-analyses and the results compared.

In Figure E.1 it can be seen that in case of linear elastic material it is enough to use 20 elements since the results are very similar to the results when 50 elements is used. 20 equally sized 2-node beam elements are thus used when having linear elastic material.

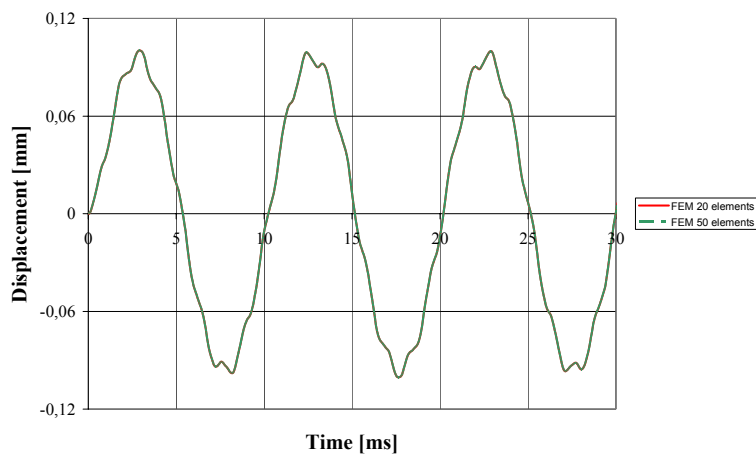

Figure E.1 Displacement-time curves when modelling beam with different numbers of elements for case (1.1), $P_1=132$ kN, $t_1=1$ ms.

In Figure E.2 it can be seen that in case of trilinear material it is enough to use 299 elements in case of concentrated load since the results are the same as the results when 199 elements is used. It is hence also assumed that 300 elements are enough in case of uniformly distributed load.

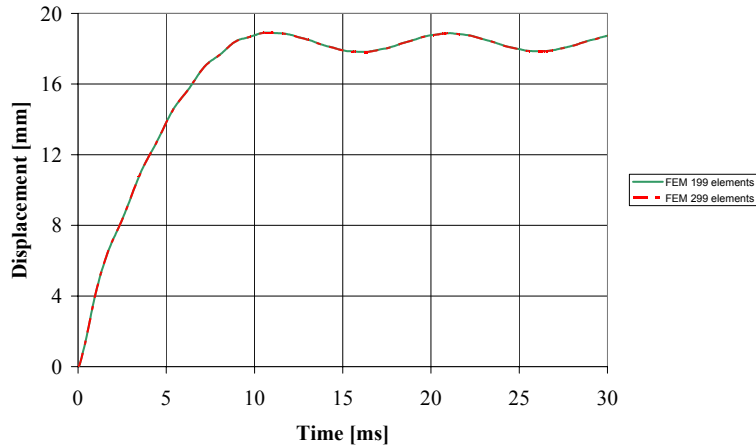

Figure E.2 Displacement-time curves when having different numbers of elements for case (1.1), $P_1 = 4220 \text{ kN}$ and $t_1 = 1 \text{ ms}$.

Due to limitations in ADINA (2004) ideal plastic material can not be modelled but in order to imitate the ideal plastic behaviour a very high elastic stiffness is used instead. Since the analysis, when having very stiff material, are computationally because very small time steps are required in order to have enough convergence for a suitable number of iteration, a sufficiently good value of the modulus of elasticity shall be found. This is done by comparing results from analyses where different values of the modulus of elasticity is used. In Figure E.3 it is seen that when having $E = 5000 \text{ GPa}$ no noticeable vibrations occurs after the maximum value of the displacement is reached. This behaviour is wanted since for ideal plastic material there will be no vibrations when the maximum value of the displacement is reached, see Figure E.4.

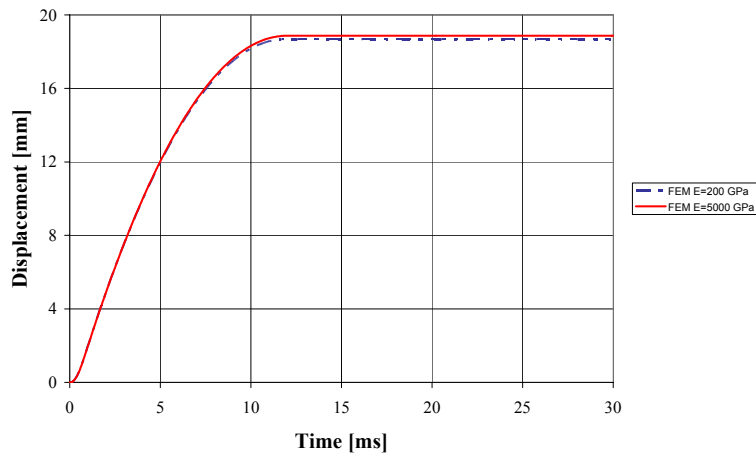

Figure E.3 Displacement-time curves when having different values of the modulus of elasticity for case (1.1), $P_1 = 4810 \text{ kN}$ and $t_1 = 1 \text{ ms}$.

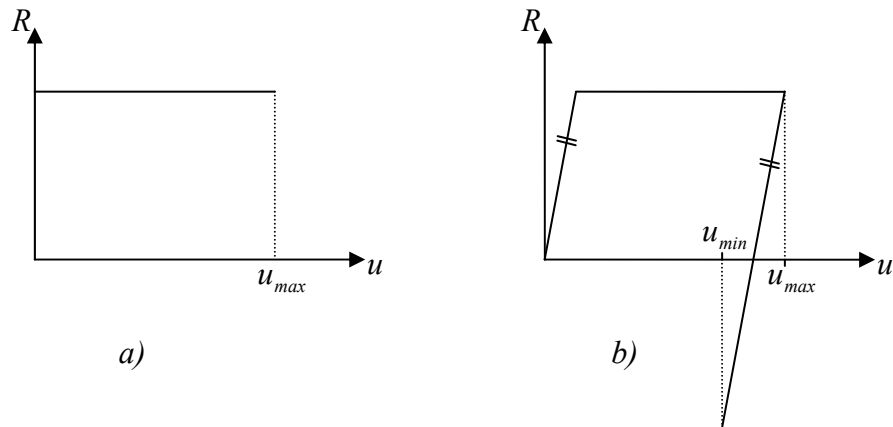

Figure E.4 For ideal plastic material (a) no vibrations will occur after the maximum value is reached but for elastic-plastic material (b) vibrations will occur

APPENDIX F Standardized shapes of deflection

In this Appendix the standardized shapes of deflections in from the FE analyses in are shown together with the assumed shape of deformation used in the SDOF analyses. Only the cases not shown in Section 7.2.3 are shown here.

F.1 Elastic range

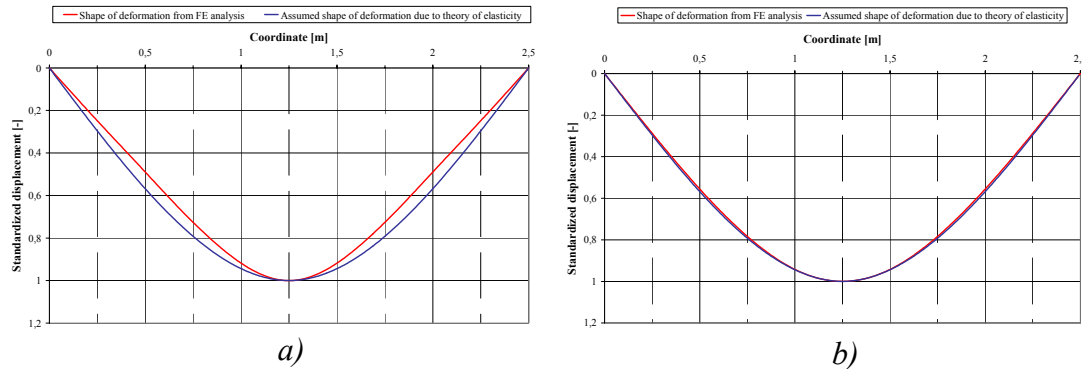

Figure F.1 Standardized displacement along the beam in a) case (1.1) and b) case (1.2) compared to the assumed shape of displacement in the SDOF analyses.

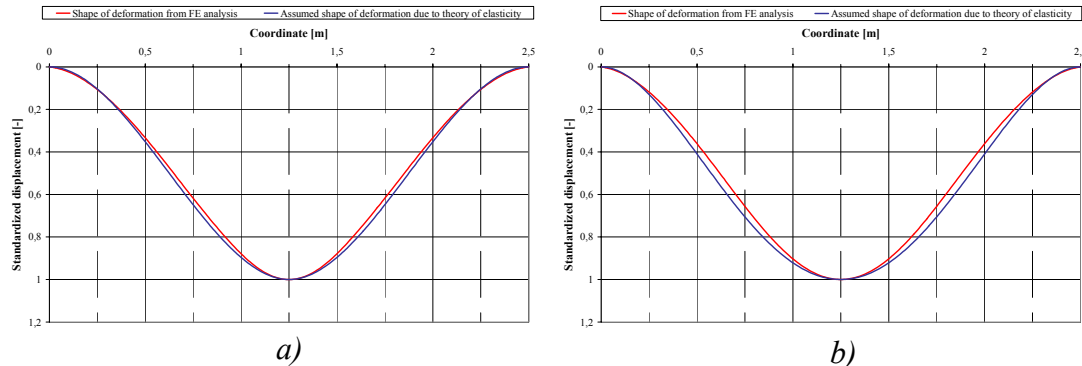

Figure F.2 Standardized displacement along the beam in a) case (2.1) and b) case (2.2) compared to the assumed shape of displacement in the SDOF analyses.

F.2 Elastoplastic range

In the elastoplastic range the assumed shape of deformation in the SDOF analyses is not defined. However, it shall be in between the assumed shape in the elastic range and the assumed shape in the plastic range.

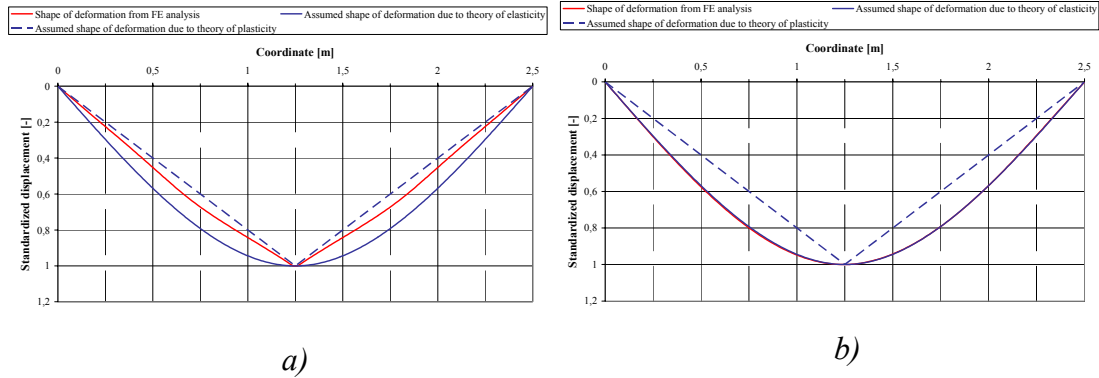

Figure F.3 Standardized displacement along the beam in a) case (1.1) and b) case (1.2) compared to the assumed shape of displacement in the SDOF analyses.

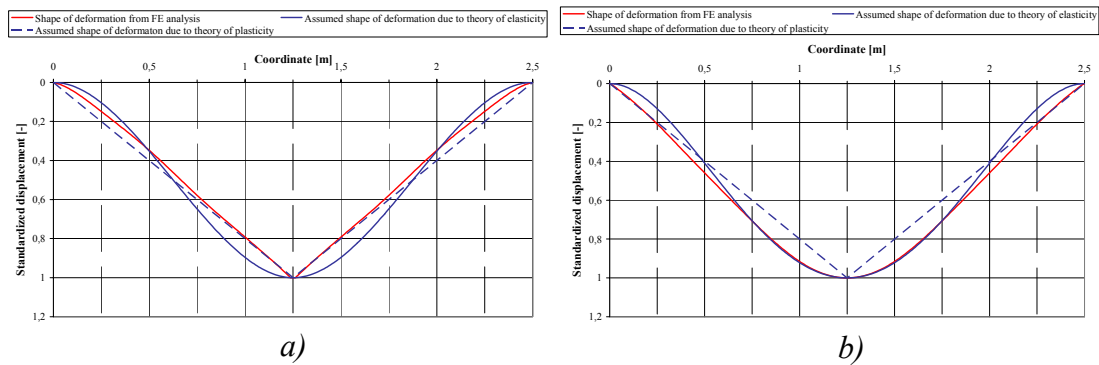

Figure F.4 Standardized displacement along the beam in a) case (1.2) and b) case (2.2) compared to the assumed shape of displacement in the SDOF analyses.

F.3 Plastic range

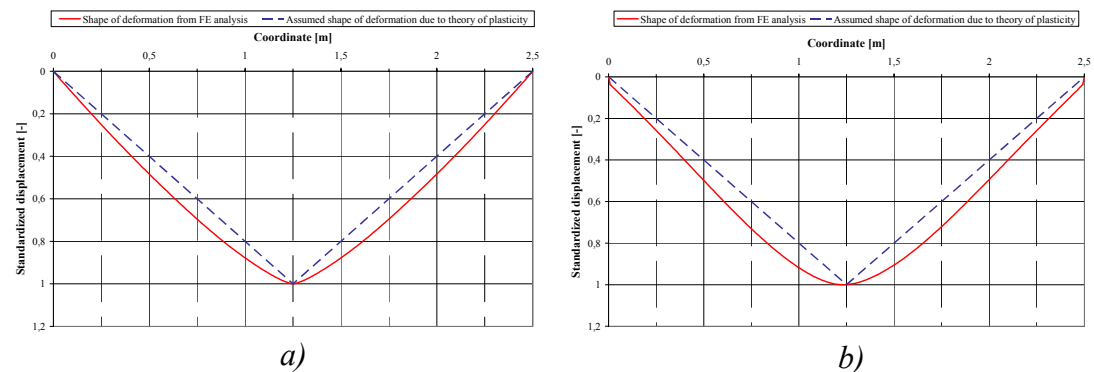

Figure F.5 Standardized displacement along the beam in a) case (1.2) and b) case (2.2) compared to the assumed shape of displacement in the SDOF analyses.

APPENDIX G **Beam equations for linear elastic and ideal plastic material**

In this appendix beam equations for case (1.1), (1.2), (2.1) and (2.2), shown in Figure 6.7, with linear elastic and ideal plastic material are derived. Analytical expressions for the maximum value of the deflection for the beams subjected to characteristic impulse loads are derived.

G.1 Simply supported beam subjected to concentrated load - Case (1.1)

Beam equations for a simply supported beam subjected to a concentrated load, shown in Figure G.1, are here derived for linear elastic and ideal plastic material.

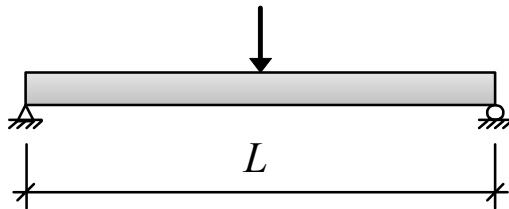

Figure G.1 Simply supported beam subjected to concentrated load.

G.1.1 Linear elastic material

If the most stressed part of the cross-section is located at the distance z from the neutral layer the maximum value of the moment can, in case of linear elastic material, be expressed as:

$$M_{el} = \sigma \frac{I}{z} \tag{G.1}$$

where σ is the stress and I is the moment of inertia.

The maximum value of the moment will appear in the middle of the beam and can in case of a simply supported beam be expressed as (brought from elementary cases):

$$M_{el} = \frac{PL}{4} \tag{G.2}$$

The maximum value of the internal resisting force is equal to the highest value of the load. Equations (G.1) and (G.2) gives the expression for the maximum internal resisting force in case of linear elastic material:

$$R_m = P_{\max} = \frac{4M_{el}}{L} = \frac{4\sigma I}{zL} \quad (\text{G.3})$$

The expression for the midpoint deflection can be found in elementary cases and is:

$$u = \frac{PL^3}{48EI} \quad (\text{G.4})$$

and the stiffness of the linear elastic beam K is:

$$K = \frac{P}{u} = \frac{48EI}{L^3} \quad (\text{G.5})$$

Using Table 9.1, Equations (G.3), (G.4) and the values of the transformation factors, listed in Table 6.1, the equations for the simply supported beam with linear elastic material, subjected to a concentrated load can be expressed as:

$$P_c = \kappa_{KP} \frac{R_m}{2} = \kappa_{KP} \frac{4\sigma I}{2zL} = \frac{2\sigma I}{zL} \quad (\text{G.6})$$

$$I_c = \sqrt{\kappa_{KP}\kappa_{MP}} \frac{R_m}{\sqrt{K/M}} = \sqrt{0.4857} \frac{4\sigma I}{zL} \sqrt{\frac{ML^3}{48EI}} \approx 0.402 \sqrt{\frac{ML}{EI}} \frac{\sigma I}{z} \quad (\text{G.7})$$

$$u_{\max}(P_c) = \frac{2P_c}{\kappa_{KP}K} = \frac{2P_c L^3}{48EI} \approx 0.0417 \frac{P_c L^3}{EI} \quad (\text{G.8})$$

$$u_{\max}(I_c) = \frac{I_c}{\sqrt{\kappa_{KP}\kappa_{MP}} \sqrt{MK}} = \frac{I_c \sqrt{L^3}}{\sqrt{0.4857 \cdot 48EIM}} \approx 0.207 \frac{I_c \sqrt{L^3}}{\sqrt{EIM}} \quad (\text{G.9})$$

G.1.2 Ideal plastic material

The maximum value of the moment is the plastic moment, M_{pl} , and appears in the middle of the beam, where a plastic hinge is assumed. In case of a simply supported beam subjected to a concentrated load M_{pl} is (brought from elementary cases):

$$M_{pl} = \frac{P_{pl}L}{4} \quad (\text{G.10})$$

where P_{pl} is the value of the external load when yielding starts.

The maximum value of the internal resisting force is equal to the external load for which yielding starts and can by means of Equation (G.10) be expressed as:

$$R_m = P_{pl} = \frac{4M_{pl}}{L} \quad (G.11)$$

Using Table 9.1, Equations (G.10), (G.11) and the values of the transformation factors, listed in Table 6.1, the equations for the simply supported beam with ideal plastic material, subjected to a concentrated load can be expressed as:

$$P_c = \kappa_{KP} R_m = 4 \frac{M_{pl}}{L} \quad (G.12)$$

$$I_c = \sqrt{2\kappa_{KP}\kappa_{MP}R_mu_{\max}M} = \sqrt{\frac{2}{3}} \sqrt{\frac{4M_{pl}Mu_{\max}}{L}} \approx 1.63 \sqrt{\frac{M_{pl}Mu_{\max}}{L}} \quad (G.13)$$

$$u_{\max}(I_c) = \frac{I_c^2}{\kappa_{KP}\kappa_{MP}2R_mM} = \frac{I_c^2L}{2/3 \cdot 4M_{pl}M} = 0.375 \frac{I_c^2L}{M_{pl}M} \quad (G.14)$$

G.1.3 Summary of beam equations for case (1.1)

The beam equations derived in Section G.1.1 and G.1.2 are summarised in Table G.1 .

Table G.1 Beam equations for a simply supported beam subjected to concentrated load.

<p>I. Linear elastic material</p> $P_c = \frac{2\sigma I}{zL}$ $I_c \approx 0.402 \sqrt{\frac{ML}{EI}} \frac{\sigma I}{z}$ $u_{\max}(P_c) \approx 0.0417 \frac{P_c L^3}{EI_t}$ $u_{\max}(I_c) \approx 0.207 \frac{I_c \sqrt{L^3}}{\sqrt{EIM}}$ <p>II. Ideal plastic material</p> $P_c = 4 \frac{M_{pl}}{L}$ $I_c \approx 1.63 \sqrt{\frac{M_{pl}Mu_{\max}}{L}}$ $u_{\max}(I_c) = 0.375 \frac{I_c^2 L}{M_{pl}M}$

G.2 Simply supported beam subjected to distributed load - Case (1.2)

Beam equations for a simply supported beam subjected to a uniformly distributed load, shown in Figure G.2, are here derived for linear elastic and ideal plastic material.

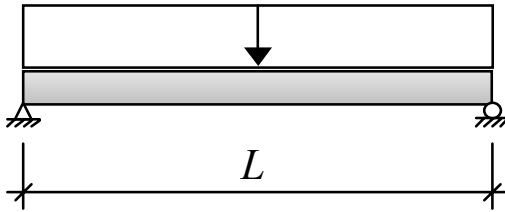

Figure G.2 Simply supported beam subjected to uniformly distributed load

G.2.1 Linear elastic material

If the most stressed part of the cross-section is located at the distance z from the neutral layer the maximum value of the moment can, in case of linear elastic material, be expressed as:

$$M_{el} = \sigma \frac{I}{z} \quad (\text{G.15})$$

where σ is the stress and I is the moment of inertia.

The maximum value of the moment will appear in the middle of the beam and can in case of a simply supported beam be expressed as (brought from elementary cases):

$$M_{el} = \frac{PL}{8} \quad (\text{G.16})$$

where P is the value of the external load.

The maximum value of the internal resisting force is equal to the highest value of the load. Equations (G.15) and (G.16) gives the expression for the maximum internal resisting force in case of linear elastic material:

$$R_m = P_{\max} = \frac{8M_{el}}{L} = \frac{8\sigma I}{zL} \quad (\text{G.17})$$

The expression for the midpoint deflection can be found in elementary cases and is:

$$u = \frac{5PL^3}{384EI} \quad (\text{G.18})$$

and the stiffness of the linear elastic beam K is:

$$K = \frac{P}{u} = \frac{384EI}{5L^3} \quad (\text{G.19})$$

Using Table 9.1, Equations (G.17), (G.19) and the values of the transformation factors, listed in Table 6.1, the equations for the simply supported beam with linear elastic material, subjected to a uniformly distributed load can be expressed as:

$$P_c = \kappa_{KP} \frac{R_m}{2} = \kappa_{KP} \frac{8\sigma I}{2zL} = \frac{4\sigma I}{zL} \quad (\text{G.20})$$

$$I_c = \sqrt{\kappa_{KP}\kappa_{MP}} \frac{R_m}{\sqrt{K/M}} = \sqrt{0.7875} \frac{8\sigma I}{zL} \sqrt{\frac{5ML^3}{384EI}} \approx 0.801 \sqrt{\frac{ML}{EI}} \frac{\sigma I}{z} \quad (\text{G.21})$$

$$u_{\max}(P_c) = \frac{2P_c}{\kappa_{KP}K} = \frac{10P_cL^3}{384EI} \approx 0.0206 \frac{P_cL^3}{EI} \quad (\text{G.22})$$

$$u_{\max}(I_c) = \frac{I_c}{\sqrt{\kappa_{KP}\kappa_{MP}}\sqrt{MK}} = \frac{I_c\sqrt{5L^3}}{\sqrt{0.7875 \cdot 384EIM}} \approx 0.129 \frac{I_c\sqrt{L^3}}{\sqrt{EIM}} \quad (\text{G.23})$$

G.2.2 Ideal plastic material

The maximum value of the moment is the plastic moment, M_{pl} , and it will appear in the middle of the beam, where a plastic hinge is assumed, and can in case of a simply supported beam be expressed as (brought from elementary cases):

$$M_{pl} = \frac{P_{pl}L}{8} \quad (\text{G.24})$$

where P_{pl} is the value of the external load when yielding starts.

The maximum value of the internal resisting force is equal to the external load for which yielding starts and can by means of Equation (G.10) be expressed as:

$$R_m = P_{pl} = \frac{8M_{pl}}{L} \quad (\text{G.25})$$

Using Table 9.1, Equations (G.24), (G.25) and the values of the transformation factors, listed in Table 6.1, the equations for the simply supported beam with ideal plastic material, subjected to a uniformly distributed load can be expressed as:

$$P_c = \kappa_{KP} R_m = 8 \frac{M_{pl}}{L} \quad (G.26)$$

$$I_c = \sqrt{2\kappa_{KP}\kappa_{MP}R_mu_{\max}M} = \sqrt{\frac{4}{3}} \sqrt{\frac{8M_{pl}Mu_{\max}}{L}} \approx 3.27 \sqrt{\frac{M_{pl}Mu_{\max}}{L}} \quad (G.27)$$

$$u_{\max}(I_c) = \frac{I_c^2}{\kappa_{KP}\kappa_{MP}2R_mM} = \frac{I_c^2L}{4/3 \cdot 8M_{pl}M} = 0.0938 \frac{I_c^2L}{M_{pl}M} \quad (G.28)$$

G.2.3 Summary of beam equations for case (1.2)

The beam equations derived in Section G.2.1 and G.2.2 are summarised in Table G.2 below.

Table G.2 *Beam equations for a simply supported beam subjected to uniformly distributed load.*

<p>I. Linear elastic material</p> $P_c = 4 \frac{\sigma l}{zL}$ $I_c \approx 0.810 \sqrt{\frac{ML}{EI}} \frac{\sigma l}{z}$ $u_{\max}(P_c) \approx 0.0260 \frac{P_c L^3}{EI}$ $u_{\max}(I_c) \approx 0.129 \frac{I_c \sqrt{L^3}}{\sqrt{EIM}}$ <p>II. Ideal plastic material</p> $P_c = 8 \frac{M_{pl}}{L}$ $I_c \approx 3.27 \sqrt{\frac{M_{pl}Mu_{\max}}{L}}$ $u_{\max}(I_c) = 0.0938 \frac{I_c^2 L}{M_{pl}M}$

G.3 Fixed beam subjected to concentrated load - Case (2.1)

Beam equations for a beam fixed in both ends subjected to a concentrated load, shown in Figure G.3, are here derived for linear elastic and ideal plastic material.

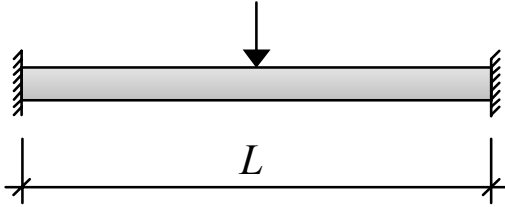

Figure G.3 Fixed beam subjected to concentrated load

G.3.1 Linear elastic material

If the most stressed part of the cross-section is located at the distance z from the neutral layer the maximum value of the moment can, in case of linear elastic material, be expressed as:

$$M_{el} = \sigma \frac{I}{z} \quad (\text{G.29})$$

where σ is the stress and I is the moment of inertia.

The maximum value of the moment will appear in the middle of the beam and at the supports and can in case of a beam, fixed in both ends, be expressed as (brought from elementary cases):

$$M_{el} = \frac{PL}{8} \quad (\text{G.30})$$

where P is the value of the external load.

The maximum value of the internal resisting force is equal to the highest value of the load. Using this statement together with Equations (G.29) and (G.30) gives the expression for the maximum internal resisting force in case of linear elastic material:

$$R_m = P_{\max} = \frac{8M_{el}}{L} = \frac{8\sigma I}{zL} \quad (\text{G.31})$$

The expression for the midpoint deflection can be found in elementary cases and is:

$$u = \frac{PL^3}{192EI} \quad (\text{G.32})$$

and the stiffness of the linear elastic beam K is:

$$K = \frac{P}{u} = \frac{192EI}{L^3} \quad (\text{G.33})$$

Using Table 9.1, Equations (G.31), (G.33) and the values of the transformation factors, listed in Table 6.1, the equations for the beam fixed in both ends with linear elastic material, subjected to a concentrated load can be expressed as:

$$P_c = \kappa_{KP} \frac{R_m}{2} = \kappa_{KP} \frac{8\sigma I_t}{2zL} = \frac{4\sigma I}{zL} \quad (\text{G.34})$$

$$I_c = \sqrt{\kappa_{KP}\kappa_{MP}} \frac{R_m}{\sqrt{K/M}} = \sqrt{0.3714} \frac{8\sigma I}{zL} \sqrt{\frac{ML^3}{192EI}} \approx 0.352 \sqrt{\frac{ML}{EI}} \frac{\sigma I}{z} \quad (\text{G.35})$$

$$u_{\max}(P_c) = \frac{2P_c}{\kappa_{KP}K} = \frac{2P_c L^3}{192EI} = 0.0104 \frac{P_c L^3}{EI} \quad (\text{G.36})$$

$$u_{\max}(I_c) = \frac{I_c}{\sqrt{\kappa_{KP}\kappa_{MP}}\sqrt{MK}} = \frac{I_c \sqrt{L^3}}{\sqrt{0.3714 \cdot 192EIM}} \approx 0.118 \frac{I_c \sqrt{L^3}}{\sqrt{EIM}} \quad (\text{G.37})$$

G.3.2 Ideal plastic material

The maximum value of the moment is the plastic moment, M_{pl} , and it will appear in the middle of the beam and at the supports, where plastic hinges are assumed if it is assumed that the field moment equals the support moments. M_{pl} is in case of a beam, fixed in both ends, be expressed as (brought from elementary cases):

$$M_{pl} = \frac{P_{pl}L}{8} \quad (\text{G.38})$$

where P_{pl} is the value of the external load when yielding starts.

The maximum value of the internal resisting force is equal to the external load for which yielding starts and can by means of Equation (G.38) be expressed as:

$$R_m = P_{pl} = \frac{8M_{pl}}{L} \quad (\text{G.39})$$

Using Table 9.1, Equations (G.38), (G.39) and the values of the transformation factors, listed in Table 6.1, the values for the beam fixed in both ends with ideal plastic material, subjected to a concentrated load can be expressed as:

$$P_c = \kappa_{KP} R_m = 8 \frac{M_{pl}}{L} \quad (\text{G.40})$$

$$I_c = \sqrt{2\kappa_{KP}\kappa_{MP}R_m u_{\max} M} = \sqrt{\frac{2}{3}} \sqrt{\frac{8M_{pl}Mu_{\max}}{L}} \approx 2.31 \sqrt{\frac{M_{pl}Mu_{\max}}{L}} \quad (G.41)$$

$$u_{\max}(I_c) = \frac{I_c^2}{\kappa_{KP}\kappa_{MP}2R_m M} = \frac{I_c^2 L}{2/3 \cdot 8M_{pl}M} = 0.188 \frac{I_c^2 L}{M_{pl}M} \quad (G.42)$$

G.3.3 Summary of beam equations for case (2.1)

The beam equations derived in Section G.3.1 and G.3.2 are summarised in Table G.3 below.

Table G.3 Beam equations for fixed beam subjected to concentrated load.

<p>I. Linear elastic material</p> $P_c = 4 \frac{\sigma l}{zL}$ $I_c \approx 0.352 \sqrt{\frac{IML}{E}} \frac{\sigma}{z}$ $u_{\max}(P_c) \approx 0.0104 \frac{P_c L^3}{EI}$ $u_{\max}(I_c) \approx 0.118 \frac{I_c \sqrt{L^3}}{\sqrt{EIM}}$ <p>II. Ideal plastic material</p> $P_c = 8 \frac{M_{pl}}{L}$ $I_c \approx 2.31 \sqrt{\frac{M_{pl}Mu_{\max}}{L}}$ $u_{\max}(I_c) \approx 0.188 \frac{I_c^2 L}{M_{pl}M}$
--

G.4 Fixed beam subjected to distributed load - Case (2.2)

Beam equations for beam, fixed in both ends, subjected to a uniformly distributed load, shown in Figure G.4, are here derived for linear elastic and ideal plastic material.

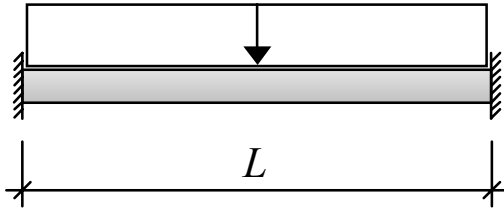

Figure G.4 Fixed beam subjected to uniformly distributed load

G.4.1 Linear elastic material

If the most stressed part of the cross-section is located at the distance z from the neutral layer the maximum value of the moment can, in case of linear elastic material, be expressed as:

$$M_{el} = \sigma \frac{I}{z} \quad (\text{G.43})$$

where σ is the stress and I is the moment of inertia.

The maximum value of the moment will appear at the supports and can in case of a beam, fixed in both ends, be expressed as (brought from elementary cases):

$$M_{el} = \frac{PL}{12} \quad (\text{G.44})$$

where P is the value of the external load.

The maximum value of the internal resisting force is equal to the highest value of the load. Using this statement together with Equations (G.43) and (G.44) gives the expression for the maximum internal resisting force in case of linear elastic material:

$$R_m = P_{\max} = \frac{12M_{el}}{L} = \frac{12\sigma I}{zL} \quad (\text{G.45})$$

The expression for the midpoint deflection can be found in elementary cases and is:

$$u = \frac{PL^3}{384EI} \quad (\text{G.46})$$

and the stiffness of the linear elastic beam K is:

$$K = \frac{P}{u} = \frac{384EI}{L^3} \quad (\text{G.47})$$

Using Table 9.1, Equations (G.45), (G.47) and the values of the transformation factors, listed in Table 6.1, the equations for the beam, fixed in both ends, with linear elastic material, subjected to a uniformly distributed load can be expressed as:

$$P_c = \kappa_{KP} \frac{R_m}{2} = \kappa_{KP} \frac{12\sigma I_t}{2zL} = \frac{6\sigma I}{zL} \quad (G.48)$$

$$I_c = \sqrt{\kappa_{KP}\kappa_{MP}} \frac{R_m}{\sqrt{K/M}} = \sqrt{0.7617} \frac{12\sigma I}{zL} \sqrt{\frac{ML^3}{384EI}} \approx 0.534 \sqrt{\frac{ML}{EI}} \frac{\sigma I}{z} \quad (G.49)$$

$$u_{\max}(P_c) = \frac{2P_c}{\kappa_{KP}K} = \frac{2P_c L^3}{384EI} = 0.00521 \frac{P_c L^3}{EI} \quad (G.50)$$

$$u_{\max}(I_c) = \frac{I_c}{\sqrt{\kappa_{KP}\kappa_{MP}}\sqrt{MK}} = \frac{I_c \sqrt{L^3}}{\sqrt{0.7617 \cdot 384EIM}} \approx 0.0585 \frac{I_c \sqrt{L^3}}{\sqrt{EIM}} \quad (G.51)$$

G.4.2 Ideal plastic material

The maximum value of the moment is the plastic moment, M_{pl} , and it will appear in the middle of the beam and at the supports, where a plastic hinges are assumed, and can in case of a beam, fixed in both ends, be expressed as (brought from elementary cases):

$$M_{pl} = \frac{P_{pl}L}{16} \quad (G.52)$$

where P_{pl} is the value of the external load when yielding starts.

The maximum value of the internal resisting force is equal to the external load for which yielding starts and can by means of Equation (G.52) be expressed as:

$$R_m = P_{pl} = \frac{16M_{pl}}{L} \quad (G.53)$$

Using Table 9.1, Equations (G.52), (G.53) and the values of the transformation factors, listed in Table 6.1, the equations for the beam, fixed in both ends, with ideal plastic material, subjected to a uniformly distributed load can be expressed as:

$$P_c = \kappa_{KP} R_m = 16 \frac{M_{pl}}{L} \quad (G.54)$$

$$I_c = \sqrt{2\kappa_{KP}\kappa_{MP}} R_m u_{\max} M = \sqrt{\frac{2}{3}} \sqrt{\frac{16M_{pl}Mu_{\max}}{L}} \approx 3.26 \sqrt{\frac{M_{pl}Mu_{\max}}{L}} \quad (G.55)$$

$$u_{\max}(I_c) = \frac{I_c^2}{\kappa_{KP} \kappa_{MP} 2R_m M} = \frac{I_c^2 L}{2/3 \cdot 16 M_{pl} M} = 0.0938 \frac{I_c^2 L}{M_{pl} M} \quad (\text{G.56})$$

G.4.3 Summary of beam equations for case (2.2)

The beam equations derived in Section G.4.1 and G.4.2 are summarised in Table G.4.

Table G.4 Beam equations for fixed beam subjected to uniformly distributed load.

<p>I. Linear elastic material</p> $P_c = 6 \frac{\sigma l}{zL}$ $I_c \approx 0.534 \sqrt{\frac{ML}{EI}} \frac{\sigma l}{z}$ $u_{\max}(P_c) \approx 0.00521 \frac{P_c L^3}{EI}$ $u_{\max}(I_c) \approx 0.0585 \frac{I_c \sqrt{L^3}}{\sqrt{EIM}}$
<p>II. Ideal plastic material</p> $P_c = 16 \frac{M_{pl}}{L}$ $I_c \approx 3.26 \sqrt{\frac{M_{pl} M u_{\max}}{L}}$ $u_{\max}(I_c) \approx 0.0938 \frac{I_c^2 L}{M_{pl} M}$

APPENDIX H Tables of damage

In case of linear elastic material the relation between the impulse load factor γ_I and pressure load factor γ_P , calculated as in Section 11.1.1, is shown in Table H.1. Observe that some of the values also are shown in Table 11.1.

Table H.1 Relation between γ_P and γ_I for linear elastic material.

$\gamma_P = \frac{P_1}{P_c}$	$\gamma_I = I/I_c$			$\gamma_I = \frac{I}{I_c}$	$\gamma_P = P_1/P_c$		
	$n=0$	$n=1$	$n=2$		$n=0$	$n=1$	$n=2$
1.01	1.444	41.13	64.15	1.01	4.144	6.813	8.525
1.05	1.324	8.491	11.17	1.05	1.959	3.177	3.911
1.1	1.255	4.570	5.931	1.1	1.469	2.389	2.924
1.3	1.141	1.984	2.455	1.3	1.066	1.691	1.984
1.5	1.095	1.490	1.776	1.5	1.003	1.493	1.694
1.6	1.080	1.373	1.610	1.6	1.000	1.434	1.607
1.7	1.069	1.294	1.494	1.7	1.000	1.388	1.541
1.8	1.060	1.237	1.408	1.8	1.000	1.351	1.488
1.9	1.053	1.196	1.343	1.9	1.000	1.321	1.445
2.0	1.047	1.166	1.293	2.0	1.000	1.296	1.409
2.2	1.038	1.126	1.220	2.2	1.000	1.256	1.353
2.4	1.032	1.099	1.171	2.4	1.000	1.226	1.310
2.6	1.026	1.080	1.137	2.6	1.000	1.202	1.277
2.8	1.023	1.067	1.112	2.8	1.000	1.183	1.250
3	1.020	1.057	1.094	3	1.000	1.167	1.228
3.5	1.014	1.040	1.064	3.5	1.000	1.138	1.187
4	1.011	1.030	1.047	4	1.000	1.117	1.159
4.5	1.008	1.023	1.037	4.5	1.000	1.102	1.138
5	1.007	1.019	1.029	5	1.000	1.090	1.122
6	1.005	1.013	1.020	6	1.000	1.073	1.099
7	1.003	1.009	1.015	7	1.000	1.062	1.083
8	1.003	1.007	1.011	8	1.000	1.053	1.072

$\gamma_P = \frac{P_1}{P_c}$	$\gamma_I = I/I_c$			$\gamma_I = \frac{I}{I_c}$	$\gamma_P = P_1/P_c$		
	$n=0$	$n=1$	$n=2$		$n=0$	$n=1$	$n=2$
9	1.002	1.006	1.009	9	1.000	1.047	1.063
10	1.002	1.005	1.007	10	1.000	1.042	1.056
20	1.000	1.001	1.002	20	1.000	1.020	1.028
30	1.000	1.000	1.001	30	1.000	1.014	1.019
40	1.000	1.000	1.000	40	1.000	1.010	1.014
50	1.000	1.000	1.000	50	1.000	1.008	1.015
100	1.000	1.000	1.000	100	1.000	1.005	1.013

In case of ideal plastic material the relation between the impulse load factor γ_I and pressure load factor γ_P , calculated as in Section 11.1.2, is shown in Table H.2

Table H.2 Relation between γ_P and γ_I for ideal plastic material.

$\gamma_P = \frac{P_1}{P_c}$	$\gamma_I = I/I_c$			$\gamma_I = \frac{I}{I_c}$	$\gamma_P = P/P_c$		
	$n=0$	$n=1$	$n=2$		$n=0$	$n=1$	$n=2$
1.01	10.05	441.8	587.5	1.01	50.73	67.67	76.13
1.05	4.583	42.87	56.25	1.05	10.76	14.34	16.14
1.1	3.317	16.571	21.58	1.1	5.763	7.688	8.645
1.3	2.082	4.454	5.569	1.3	2.452	3.269	3.678
1.5	1.732	2.756	3.330	1.5	1.800	2.400	2.700
1.6	1.633	2.385	2.839	1.6	1.641	2.188	2.459
1.7	1.558	2.137	2.508	1.7	1.529	2.039	2.286
1.8	1.500	1.961	2.270	1.8	1.446	1.929	2.154
1.9	1.453	1.831	2.094	1.9	1.383	1.8433	2.050
2.0	1.414	1.732	1.957	2.0	1.333	1.775	1.966
2.2	1.354	1.593	1.762	2.2	1.260	1.671	1.837
2.4	1.309	1.500	1.631	2.4	1.210	1.595	1.742
2.6	1.275	1.433	1.537	2.6	1.174	1.537	1.668

$\gamma_P = \frac{P_1}{P_c}$	$\gamma_I = I/I_c$			$\gamma_I = \frac{I}{I_c}$	$\gamma_P = P/P_c$		
	$n=0$	$n=1$	$n=2$		$n=0$	$n=1$	$n=2$
2.8	1.247	1.382	1.468	2.8	1.146	1.491	1.610
3	1.225	1.342	1.414	3	1.125	1.453	1.562
3.5	1.183	1.272	1.324	3.5	1.089	1.382	1.474
4	1.155	1.225	1.266	4	1.067	1.333	1.412
4.5	1.134	1.193	1.225	4.5	1.052	1.297	1.367
5	1.118	1.168	1.196	5	1.042	1.269	1.332
6	1.095	1.134	1.155	6	1.029	1.228	1.280
7	1.080	1.111	1.128	7	1.021	1.199	1.245
8	1.069	1.095	1.110	8	1.016	1.178	1.218
9	1.061	1.084	1.095	9	1.013	1.162	1.198
10	1.054	1.074	1.085	10	1.010	1.148	1.182
20	1.026	1.035	1.040	20	1.003	1.087	1.106
30	1.017	1.023	1.026	30	1.001	1.064	1.079
40	1.013	1.017	1.019	40	1.001	1.052	1.064
50	1.010	1.014	1.015	50	1.004	1.045	1.055
100	1.005	1.001	1.007	100	1.001	1.028	1.034

APPENDIX I Calculations to example

When analysing cross-section in Chapter 7 a reinforced concrete cross-section with a chosen value of the amount of reinforcement $\rho=0.335\%$ where used. Here the minimum reinforcement due to the Swedish shelter regulations, see Råddningsverket (2003) is used. Since only the amount of reinforcement is changed the material properties are the same as used in Appendix D, where the beams used in Chapter 7 are analysed.

I.1 Moment capacity and load-displacement relation

An estimated value of the required steel area in the tensile zone, according to Engström (2001) is calculated as:

$$A_s = \frac{M}{f_{st} \cdot 0.9d} \quad (\text{I.1})$$

where f_{st} is the yield stress in steel, $0.9d$ is an estimated value of the internal lever arm and M is the maximum moment in the beam, which, in case of a uniformly distributed load applied on a fixed beam can be calculated as:

$$M = \frac{qL^2}{2 \cdot 8} \quad (\text{I.2})$$

provided that it is assumed that the support moment M_s equals the moment in the midpoint M_f .

The estimated value of the required steel area in the tensile zone can now be calculated as:

$$A_s = \frac{qL^2}{2 \cdot 8 \cdot f_{st} \cdot 0.9d} = \frac{50 \cdot 10^3 \cdot 2.5^2}{2 \cdot 8 \cdot 450 \cdot 10^6 \cdot 0.9 \cdot 0.3} = 160 \text{ mm}^2 \quad (\text{I.3})$$

The minimum required amount of reinforcement is 0.14%, due to the Swedish shelter regulations, Råddningsverket (2003):

$$\begin{aligned} \rho &= \frac{A_s}{b \cdot d} \geq 0.14\% \\ \Rightarrow A_{s,\min} &= 0.14 \cdot 10^{-2} \cdot b \cdot d = 0.14 \cdot 10^{-2} \cdot 1.0 \cdot 0.3 = 420 \text{ mm}^2 \end{aligned} \quad (\text{I.4})$$

In order to have even values of reinforcing steel $\phi 10$ s150 is used, the total area of reinforcement per meter is than:

$$A_s = 524 \text{ mm}^2/\text{m} \quad (\text{I.5})$$

The same amount of reinforcement is assumed in the compression zone.

$$A'_s = A_s = 524 \text{ mm}^2/\text{m} \quad (\text{I.6})$$

The beam capacity is calculated in the same way as when analysing the beams used in Chapter 7, see Appendix D, and since the calculations is very similar only calculated values of interest are shown here, when analysing the beam used in Section 11.4.2.

I.1.1 Stadium I

The equivalent area for the cross-section in stadium I is:

$$A_I = 0.355 \text{ mm}^2 \quad (\text{I.7})$$

and the moment of inertia for stadium I is:

$$I_I = 3.64 \cdot 10^{-3} \text{ mm}^4 \quad (\text{I.8})$$

The moment when the first crack occurs in the beam is:

$$M_{cr} = 33.1 \text{ kNm} \quad (\text{I.9})$$

For a fixed beam subjected to a uniformly distributed load the value of the load corresponding to the crack moment M_{cr} is ($q_{cr} = P_{cr}/L$):

$$P_{cr} = \frac{12M_{cr}}{L} = \frac{12 \cdot 33.1 \cdot 10^3}{2.5} = 158.6 \text{ kN} \quad (\text{I.10})$$

The stiffness in the elastic range is:

$$K_I = 3332.0 \text{ MN/m} \quad (\text{I.11})$$

and the midpoint deflection of the beam when the first crack occurs is:

$$u_{cr} = 0.0476 \text{ mm} \quad (\text{I.12})$$

I.1.2 Stadium II

The equivalent area for the cross-section in stadium II is:

$$A_{II} = 0.0441 \text{ mm}^2 \quad (\text{I.13})$$

and the moment of inertia for stadium II is:

$$I_{II} = 2.12 \cdot 10^{-4} \text{ mm}^4 \quad (\text{I.14})$$

The moment when yielding starts in the steel is:

$$M_{spl} = 68.0 \text{ kNm} \quad (\text{I.15})$$

For a fixed beam subjected to a uniformly distributed load the value of the load corresponding to the moment when yielding starts M_{spl} is ($q_{spl}=P_{spl}/L$):

$$P_{spl} = \frac{12M_{spl}}{L} = \frac{12 \cdot 68.0 \cdot 10^3}{2.5} = 326.3 \text{ kN} \quad (\text{I.16})$$

The stiffness, just before yielding starts, is:

$$K_{II} = 193.8 \text{ MN/m} \quad (\text{I.17})$$

and the midpoint deflection when yielding starts is:

$$u_{spl} = 1.68 \text{ mm} \quad (\text{I.18})$$

The inclination of the load-displacement curve in between the occurrence of the first crack and the ultimate state is:

$$K' = 102.7 \text{ MN/m} \quad (\text{I.19})$$

I.1.3 Stadium III

The height of the compression zone in stadium III is:

$$x = 0.0288 \text{ m} \quad (\text{I.20})$$

and the ultimate moment is:

$$M_{pl} = 78.5 \text{ kNm} \quad (\text{I.21})$$

For a fixed beam subjected to a uniformly distributed load the value of the load corresponding to the ultimate moment M_{pl} is ($q_{pl}=P_{pl}/L$):

$$P_{pl} = \frac{16M_{pl}}{L} = \frac{16 \cdot 78.5 \cdot 10^3}{2.5} = 502.4 \text{ kN} \quad (\text{I.22})$$

The inclination of the load-displacement curve K' is used up to the load P_{pl} and the deflection for load P_{pl} is:

$$u_{pl} = 3.40 \text{ mm} \quad (\text{I.23})$$

I.2 Rotational capacity

The rotational capacity of a fixed beam subjected to a uniformly distributed load is calculated as in Section 12.2.2.3. Since no shear reinforcement is used ω_v is zero ω'_s is calculated as in Equations (12.45) and (12.46) where $A'_s = 524 \text{ mm}^2$, $f_{sc} = f_{st} = 450 \text{ MPa}$, $d = 0.3 \text{ m}$, $b_c = b = 1.0 \text{ m}$ and $f_{cc} = 22 \text{ MPa}$.

$$\omega'_s = \frac{A'_s \cdot f_{st}}{b_c \cdot d \cdot f_{cc}} = \frac{524 \cdot 10^{-6} \cdot 450 \cdot 10^6}{1.0 \cdot 0.3 \cdot 22 \cdot 10^6} = 0.03573 \quad (\text{I.24})$$

ω_s is calculated as in Equation (12.46) where $A_s = 524 \text{ mm}^2$, $f_{st} = 450 \text{ MPa}$, $d = 0.3 \text{ m}$, $b_c = b = 1.0$ and $f_{cc} = 22 \text{ MPa}$.

$$\begin{aligned} \omega_s &= \frac{A_s \cdot f_{st}}{b_c \cdot d \cdot f_{cc}} = \frac{524 \cdot 10^{-6} \cdot 450 \cdot 10^6}{1.0 \cdot 0.3 \cdot 22 \cdot 10^6} = \omega'_s = \\ &= 0.03573 \end{aligned} \quad (\text{I.25})$$

Since ω_s must be larger than or equal to 0.05 $\omega_s = 0.05$ is used.

ω_{bal} is calculated as in Equation (12.47) where $f_{st} = 450 \text{ MPa}$ and $E_s = 200 \text{ GPa}$.

$$\omega_{bal} = 0.8 \frac{3.5 \cdot 10^{-3}}{3.5 \cdot 10^{-3} + 450 / (200 \cdot 10^3)} = 0.4870 \quad (> \omega_s) \quad (\text{I.26})$$

Factor A is then:

$$\begin{aligned} A &= 1 + 0.6\omega_v + 1.7\omega'_s - 1.4 \frac{\omega_s}{\omega_{bal}} = \\ &= 1 + 1.7 \cdot 0.05 - 1.4 \frac{0.05}{0.4870} = 0.9413 \end{aligned} \quad (\text{I.27})$$

The use of not weld able, hot rolled reinforcement gives that the factor B is equal to 0.8 and $A \cdot B = 0.8 \cdot 0.9413 = 0.7530 < 1.7$.

$$B = 0.8 \quad (\text{I.28})$$

In **Fel! Hittar inte referenskölla.** the moment distribution in the beam is shown when the mechanism is about to form and an expression for the distance $l_{0, \text{support}}$ from the support to the location where the moment is zero is derived.

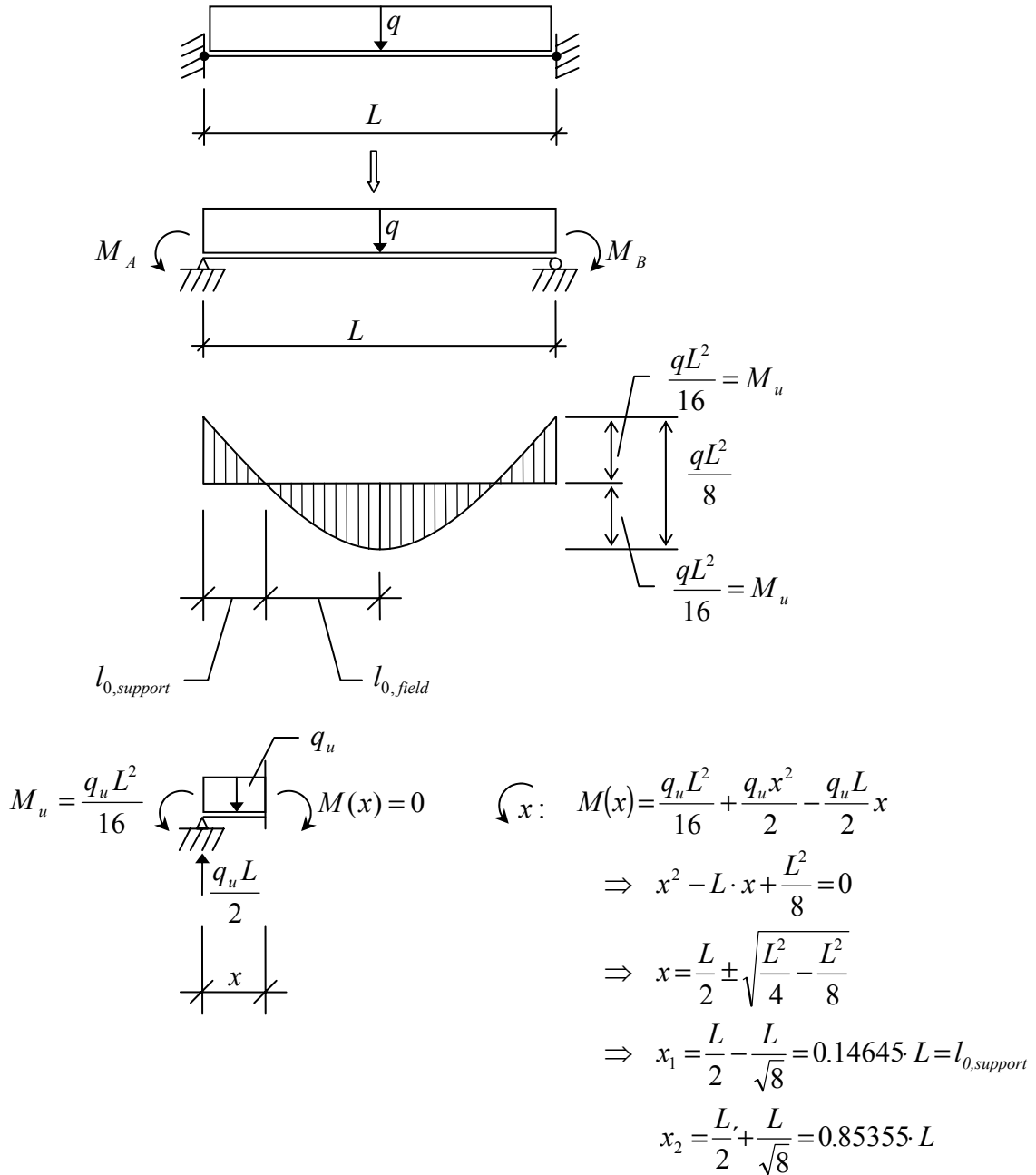

Figure I.1 Moment distribution in beam subjected to uniformly distributed load when mechanism is about to form ($q = q_{pl}$) and derivation of distance $l_{0,support}$.

Factor C , calculated as in Equations (12.51) and (12.52), depends on the location of the plastic hinge and the distance $l_{0,support}$ is:

$$l_{0,support} = 0.14645 \cdot L = 0.14645 \cdot 2.5 = 0.366 \text{ m} \quad (\text{I.29})$$

The distance $l_{0,field}$ is:

$$l_{0,field} = \frac{L}{2} - l_{0,support} = \frac{2.5}{2} - 0.14645 \cdot 2.5 = 0.884 \text{ m} \quad (\text{I.30})$$

Factor C for the support and field are then:

$$C_{support} = 10 \cdot l_{0,support} / d = 10 \cdot 0.366 / 0.3 = 12.20 \quad (\text{I.31})$$

$$C_{field} = 7 \cdot l_{0,field} / d = 7 \cdot 0.884 / 0.3 = 20.63 \quad (\text{I.32})$$

Insert Equations (I.40), (I.41), (I.44) and (I.45) into Equation (12.42) and the available rotational capacities for the plastic hinges are calculated:

$$\theta_{d,pl,support} = 0.9413 \cdot 0.8 \cdot 12.20 \cdot 10^{-3} = 0.0092 \text{ rad} \quad (\text{I.33})$$

$$\theta_{d,pl,field} = 0.9413 \cdot 0.8 \cdot 20.63 \cdot 10^{-3} = 0.0155 \text{ rad} \quad (\text{I.34})$$

The required rotational capacity is calculated as shown in Section 12.2.2.3.

By means of Equations (12.62) and (12.53) the required plastic rotation capacity can be calculated. M_{el} in Equations (12.62) corresponds here to the moment where yielding starts in the reinforcing steel, see Equation (I.15)..

$$\begin{aligned} \theta_{pl,support} &= \frac{2u_s}{L} - \frac{M_{spl}L}{16E_c I_{II}} = \\ &= \frac{2 \cdot 31.0 \cdot 10^{-3}}{2.5} - \frac{68.0 \cdot 10^3 \cdot 2.5}{16 \cdot 37.2 \cdot 10^9 \cdot 2.12 \cdot 10^{-4}} = 0.0235 \text{ rad} \end{aligned} \quad (\text{I.35})$$

$$\theta_{pl,field} = 2 \cdot \theta_{pl,support} = 2 \cdot 0.0235 = 0.0470 \text{ rad} \quad (\text{I.36})$$

I.3 Rotational capacity for beam analysed in Appendix D

Since the same cross-section used in this example also where used when comparing the SDOF analyses with FE analyses in Chapter 7 the analysis of the beam capacity is found in Appendix D, see case (2.2).

The rotational capacity is calculated in the same way as in Appendix I.2 therefore only some interesting values and the results are shown here.

$$A'_s = 1005 \text{ mm}^2, f_{sc} = f_{st} = 450 \text{ MPa}, d = 0.3 \text{ m}, b_c = b = 1.0 \text{ m} \text{ and } f_{cc} = 22 \text{ MPa.}$$

$$\omega'_s = \frac{A'_s \cdot f_{st}}{b_c \cdot d \cdot f_{cc}} = \frac{1005 \cdot 10^{-6} \cdot 450 \cdot 10^6}{1.0 \cdot 0.3 \cdot 22 \cdot 10^6} = 0.06852 \quad (\text{I.37})$$

$$\omega_s = \frac{A_s \cdot f_{st}}{b_c \cdot d \cdot f_{cc}} = \frac{1005 \cdot 10^{-6} \cdot 450 \cdot 10^6}{1.0 \cdot 0.3 \cdot 22 \cdot 10^6} = \omega'_s = 0.06852 \quad (> 0.05) \quad (\text{I.38})$$

$$\omega_{bal} = 0.8 \frac{3.5 \cdot 10^{-3}}{3.5 \cdot 10^{-3} + 450 / (200 \cdot 10^3)} = 0.4870 \quad (> \omega_s) \quad (\text{I.39})$$

Factor A is then:

$$A = 1 + 0.6\omega_v + 1.7\omega'_s - 1.4 \frac{\omega_s}{\omega_{bal}} = 1 + 1.7 \cdot 0.06852 - 1.4 \frac{0.06852}{0.4870} = 0.9195 \quad (\text{I.40})$$

The use of not weld able, hot rolled reinforcement gives that the factor B is equal to 0.8 and $A \cdot B = 0.8 \cdot 0.9195 = 0.74 < 1.7$.

$$B = 0.8 \quad (\text{I.41})$$

Factor C , calculated as in Equations (12.51) and (12.52), depends on the location of the plastic hinge and the distance $l_{0,support}$, as in Appendix I.2, is:

$$l_{0,support} = 0.14645 \cdot L = 0.14645 \cdot 2.5 = 0.366 \text{ m} \quad (\text{I.42})$$

The distance $l_{0,field}$, as in Appendix I.2, is:

$$l_{0,field} = \frac{L}{2} - l_{0,support} = \frac{2.5}{2} - 0.14645 \cdot 2.5 = 0.884 \text{ m} \quad (\text{I.43})$$

Factor C for the support and field are then:

$$C_{support} = 10 \cdot l_{0,support} / d = 10 \cdot 0.366 / 0.3 = 12.20 \quad (\text{I.44})$$

$$C_{field} = 7 \cdot l_{0,field} / d = 7 \cdot 0.884 / 0.3 = 20.63 \quad (\text{I.45})$$

Insert Equations (I.40), (I.41), (I.44) and (I.45) into Equation (12.42) and the available rotational capacities for the plastic hinges are calculated:

$$\theta_{d,pl,support} = 0.9195 \cdot 0.8 \cdot 12.20 \cdot 10^{-3} = 0.0090 \text{ rad} \quad (\text{I.46})$$

$$\theta_{d,pl,field} = 0.9195 \cdot 0.8 \cdot 20.63 \cdot 10^{-3} = 0.0157 \text{ rad} \quad (\text{I.47})$$

The required rotational capacity is calculated as shown in Section 12.2.2.3.

By means of Equations (12.62) and (12.53) the required plastic rotation capacity can be calculated. M_{el} in Equations (12.62) corresponds here to the moment where yielding starts in the reinforcing steel, see Equation (D.26).

$$\begin{aligned}\theta_{pl, support} &= \frac{2u_s}{L} - \frac{M_{spl}L}{16E_c I_{II}} = \\ &= \frac{2 \cdot 18.3 \cdot 10^{-3}}{2.5} - \frac{127.8 \cdot 10^3 \cdot 2.5}{16 \cdot 37.2 \cdot 10^9 \cdot 3.79 \cdot 10^{-4}} = 0.0132 \text{ rad}\end{aligned}\tag{I.48}$$

$$\theta_{pl, field} = 2 \cdot \theta_{pl, support} = 2 \cdot 0.0132 = 0.0264 \text{ rad}\tag{I.49}$$