

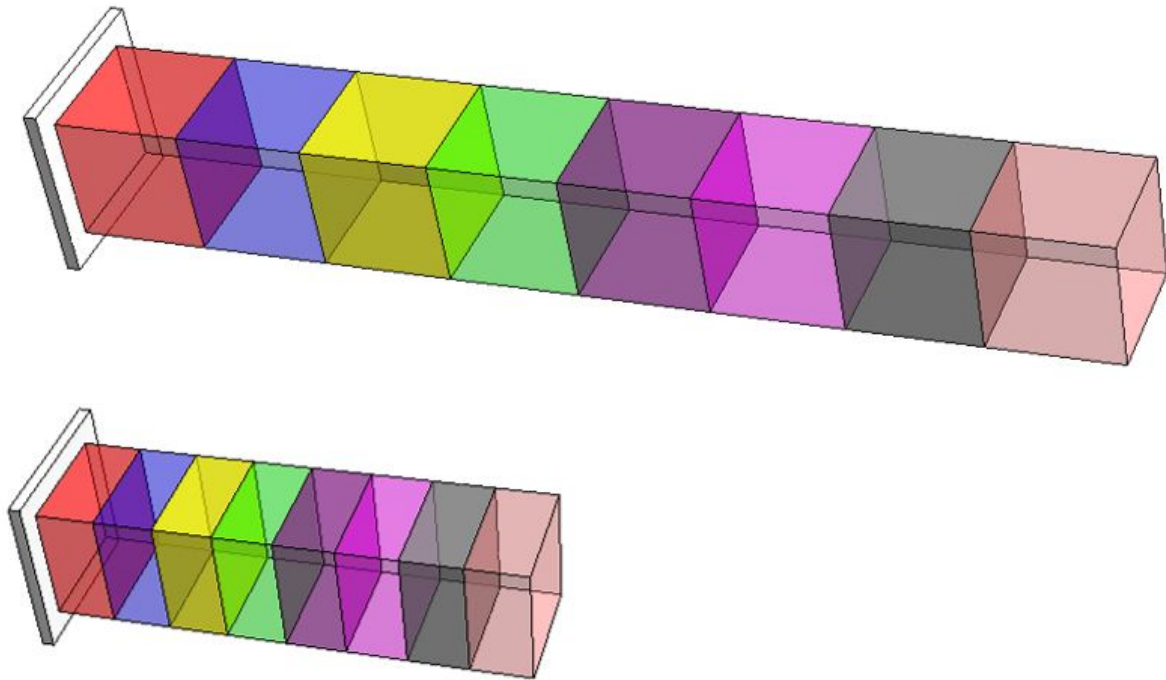

CHALMERS
UNIVERSITY OF TECHNOLOGY



Stress Wave Propagation Between Different Materials

Master's thesis in the Master's Programme Structural Engineering and Building Technology

TIM SVENSSON
FILIP TELL

Department of Civil and Environmental Engineering and Department of Applied Mechanics
Division of Structural Engineering and Division of Material and Computational Mechanics
CHALMERS UNIVERSITY OF TECHNOLOGY
Gothenburg, Sweden 2015
Master's thesis 2015:73

MASTER'S THESIS 2015:73

Stress Wave Propagation Between Different Materials

Master's thesis in the Master's Programme Structural Engineering and Building Technology

TIM SVENSSON
FILIP TELL

Department of Civil and Environmental Engineering and Department of Applied Mechanics
Division of Structural Engineering and Division of Material and Computational Mechanics
CHALMERS UNIVERSITY OF TECHNOLOGY

Gothenburg, Sweden 2015

Stress Wave Propagation Between
Different Materials
TIM SVENSSON
FILIP TELL

© TIM SVENSSON , FILIP TELL, 2015

Master's thesis 2015:73

ISSN 1652-8557

Department of Civil and Environmental Engineering and Department of Applied Mechanics

Division of Structural Engineering and Division of Material and Computational Mechanics

Chalmers University of Technology

SE-412 96 Gothenburg

Sweden

Telephone: +46 (0)31-772 1000

Cover:

Rod divided in several layers and the transformed rod with equally many layers

Chalmers Reproservice

Gothenburg, Sweden 2015

Stress Wave Propagation Between
Different Materials

Master's thesis in the Master's Programme Structural Engineering and Building Technology

TIM SVENSSON

FILIP TELL

Department of Civil and Environmental Engineering and Department of Applied Mechanics
Division of Structural Engineering and Division of Material and Computational Mechanics
Chalmers University of Technology

ABSTRACT

With the increasing threats from different terrorist organizations in the world, routines for civil protection are needed. Bomb shelters are a central part in protection of civilians and need to sustain high loading for a short period of time, which make them complex to analyse. Today many of the bomb shelters in Sweden are old and in some cases require some strengthening because of the increased terrorist threat. These shelters are often located in present buildings and tunnels, which means lack of space is a major problem.

A new technique, transformational elastodynamics are combined with the theory of wave propagation in order to find a structure which can sustain high loads but is still a thin member. The aim was to test the theories and design a small protective member. The thesis contains two parts, one literature study and a part with case studies, where different designs are tested.

Several case-studies have been done in order to learn the theory and how to make different assumptions to get reasonable results. The results are positive, where a transformation from a 1 meter long rod to a 0.5 meter long rod is possible, where both rods have the same dynamic response. Furthermore, a case study is done where real materials are applied for the small rod and the calculations show good results. The length of the transformed rod do not reach the length of 0.5 meter, but the length decreases with about 15%. Adding more materials to the material database, makes it possible to get closer to the theoretically calculated values, which can solve this problem.

The calculations are done on simple models and are not close to the reality. The models only consider plane, one-dimensional elastic waves, which are simple, but represent the theory well. In order to be able to implement the technique on real situations it is needed to test with the theory of plastic waves and shock waves. It is also needed to consider a 2- or 3-dimensional system, which is more complicated than the 1-dimensional system in this thesis. Laboratory testing is necessary in order to verify the theories.

Keywords: Stress waves, Cloaking, Transformational elastodynamics, Reflections

Utbredning av spänningsvågor mellan olika material
Examensarbete i Structural Engineering and Building Technology
TIM SVENSSON
FILIP TELL

Institutionen för Bygg- och Miljöteknik och Institutionen for Tillämpad Mekanik
Avdelningen för Konstruktionsteknik och Avdelningen för Material- och beräkningsmekanik
Chalmers tekniska högskola

SAMMANFATTNING

Med ett ökat hot från olika terroristorganisationer runt om i världen, är mänskligt skydd högt prioriterat. Skyddsrum har en central roll för att skydda människor vid ett eventuellt hot och ska kunna stå emot höga laster som verkar under en kort tidsperiod, vilket gör analysen svår. Idag är många skyddsrum gamla och är i vissa fall i behov av reparation. De är ofta integrerade i byggnader och andra konstruktioner så som tunnlar, vilket innebär att ytan för eventuella förstärkningar är liten.

Omdirigering av elastodynamiska vågor, kombinerad med den klassiska vågteorin, kan användas för att kunna konstruera ett tunt effektivt skydd mot höga laster. Målet med examensarbetet var just att designa ett tunt effektivt skydd mot höga laster. Rapporten består av en litteraturstudie och flera fallstudier.

Flera fallstudier har gjorts för att få en ökad förståelse av teorin och hur olika antaganden kan göras för att uppnå ett rimligt resultat. Resultaten har visat ett det är fullt möjligt att konstruera en stav som är 0.5 meter med samma dynamiska respons som en 1 meter lång stav. Vid ett senare stadiet i projektet har riktiga material testats för den 0.5 meters långa staven och beräkningar för denna har visat goda resultat. Längden uppnådde inte den önskade, men minskade med 15%. Om fler material tilläggs i den databas som används är det möjligt att längden minskas ytterligare och därav komma närmare en längd av 0.5 meter.

Beräkningar och modeller som gjorts är ett enklare fall med vissa antagande som inte följer verkligheten helt. Modellerna tar bara hänsyn till plana, 1-dimensionella vågor med ett elastiskt beteende, men beräkningarna visar att transformationen är möjlig. För att kunna tillämpa teorin i verkligheten är det därför viktigt att riktiga tester utförs, för att på så vis se hur plastiska deformationer och chockvågor påverkar konstruktionen. Modellen behöver utökas till 2- och 3-dimensioner, vilket efterliknar verkligheten på ett bättre sätt. Laborationstester är en metod för att ytterligare stärka teorin som används i projektet.

Nyckelord: Omdirigering av elastodynamiska vågor, Reflektioner, Spänningsvågor

CONTENTS

Abstract	i
Sammanfattning	ii
Contents	iii
Preface	vii
Nomenclature	ix
1 Introduction	1
1.1 Background	1
1.2 Purpose	1
1.3 Limitations	2
1.4 Method	2
2 Material Behaviour	3
2.1 Elastic material behaviour	3
2.2 Plastic material behaviour	3
3 Rigid Body Dynamics	6
3.1 Elastic impact	6
3.2 Plastic impact	7
4 Stress Waves	9
4.1 Different kinds of stress waves	9
4.1.1 Longitudinal waves	9
4.1.2 Transverse waves	10
4.1.3 Rayleigh waves	10
4.2 Elastic stress waves	11
4.2.1 Analysis of elastic stress waves	11
4.2.2 Energy loss and damping	13
4.3 Elastic wave reflection	14
4.3.1 Impact between two rods and elastic wave reflection	14
4.3.2 Common cases	17
4.3.3 Lagrange diagrams - Graphical description of reflections	18
4.3.4 Example of an elastic impact	19
4.4 Transformational elastodynamics	20
4.4.1 Derivation of equations	20
4.4.2 Example of finding material properties for a system with constant material properties	23
4.5 Plastic stress wave	24
4.5.1 Plastic stress waves velocities	25
CHALMERS, Civil and Environmental Engineering, Master's Thesis, 2015:73	iii

5	Shock Waves	26
5.1	1D-shock wave propagation	26
5.1.1	The conservation laws of shock waves	26
5.1.2	The equation of state	28
5.1.3	Hugoniot curve and Rayleigh line	29
5.1.4	Example of a plastic impact	30
6	Finite Element-Modelling of Dynamic Problems	32
6.1	Element types	32
7	Case Studies	33
7.1	Case study 1 - Transformation of rod with constant material properties	33
7.1.1	Calculations and modelling using LS-DYNA	35
7.1.2	Convergence study of the FEM-model	36
7.1.3	Damping	37
7.2	Case study 2 - Transformation of rod with varying material properties	38
7.2.1	Calculations and modelling using LS-DYNA	39
7.3	Case study 3 - Transformation of rod with varying material properties and a non-linear ψ -function	40
7.3.1	LS-DYNA calculations	42
7.3.2	Size of model	42
7.4	Case study 4 - Transformation of rod with varying material properties and ψ -function	42
7.4.1	LS-DYNA calculations	43
7.4.2	Size of model	43
7.5	Case study 5 - Design of rod with real materials	44
7.5.1	LS-DYNA	46
7.5.2	Size of model	46
8	Results from the Case Studies	47
8.1	Results Case Study 1	47
8.1.1	Hand calculations	47
8.1.2	LS-DYNA calculations	48
8.1.3	Rod with Damping	48
8.2	Results Case Study 2	50
8.2.1	Hand calculations	50
8.2.2	LS-DYNA calculations	54
8.3	Results Case Study 3	55
8.3.1	Hand calculations	55
8.3.2	LS-DYNA calculations	60
8.4	Results Case Study 4	61
8.4.1	Hand calculations	61
8.4.2	LS-DYNA calculations	65
8.5	Results Case Study 5	66
8.5.1	Calculation with linear ψ	67

8.5.2	Calculation with non-linear ψ	74
9	Discussion	79
10	Conclusions	82
11	References	83
Appendix A	Material properties and dynamic response calculations, Case study 1	A-1
Appendix B	Material properties and dynamic response calculations, Case study 2	B-1
Appendix C	Material properties and dynamic response calculations, Case study 3	C-1
Appendix D	Material properties and dynamic response calculations, Case study 4	D-1
Appendix E	Material properties and dynamic response calculations, Case study 5	E-1
Appendix F	MATLAB code, Case study 5	F-1
Appendix G	List of materials	G-1

PREFACE

In this master's thesis project the stress wave propagating between materials and the theory of transformational elastodynamics have been studied. The project has been carried out between January and June 2015 at the master's program Structural Engineering and Building Technology at Chalmers University of Technology.

The thesis is carried out as a collaboration between the Department of Civil and Environmental Engineering and the Department of Applied Mechanics at the Divisions of Structural Engineering and Material and Computational Mechanics at Chalmers University of Technology.

The authors would like to thank our examiners, Peter Olsson, Professor at the Division of Material and Computational Mechanics, and Joosef Leppänen, Senior Lecturer at the Division of Structural Engineering, for the help and support through the project. We would also like to thank our opponents, Jens Håkansson and Henrik Wallerman, for good collaboration and valuable tips for our report.

Gothenburg, June 2015

Tim Svensson & Filip Tell

NOMENCLATURE

Roman upper case letters

A	Cross-sectional area
E	Young's modulus
E	Energy
E_0	Energy before an impact
E_{tan}	Tangent modulus of elasticity
\hat{E}	Transformed Young's modulus
G	Shear modulus
I	Dynamic impulse
P_0	Pressure before a striking wave
P	Pressure
U_p	Particle velocity
U_{pI}	Incident particle velocity
U_{pR}	Reflected particle velocity
U_{pT}	Transmitted particle velocity
U_s	Shock front velocity
S	Shock front

Roman lower case letters

a	Length before transformation
\hat{a}	Length after transformation
c	Longitudinal wave velocity
c_T	Transversal wave velocity
c_p	Plastic wave velocity
m	Mass
l	Length
u	Displacement
x	Coordinate in a coordinate system
\hat{x}	Transformed coordinate in a coordinate system

Greek letters

σ	Compressive stress
σ_I	Incident stress wave
σ_R	Reflected stress wave
σ_T	Transmitted stress wave
σ_y	Yield limit
σ_u	Ultimate stress limit
ρ	Material density in its original state
ρ_0	Material density before a striking wave
$\hat{\rho}$	Transformed material density
ε	Strain
$\dot{\varepsilon}$	Strain rate
$\psi(x)$	Transformation function
v	Velocity
v	Volume

1 Introduction

1.1 Background

With the increasing threats from different terrorist organizations in the world, routines for civil protection are needed. Bomb shelters are a central part in protection of civilians and need to sustain high loading for a short period of time, which make them complex to analyse. Today many of the bomb shelters in Sweden are old, in some cases they require strengthening because of the increased terrorist threat. These shelters are often located in present buildings and tunnels, which means lack of space is a major problem. Therefore, the strengthening structure needs to be as small as possible in order to retain the function of the shelter. Using different materials in many layers, the amplitude of a stress wave created, e.g. a detonation from a bomb, can be decreased. This technique can be used to strengthen structures. Furthermore, a new technique to decrease the thickness of the strengthening structure is under development, where it is possible to hide stress waves in the structure.

Figure 1.1.1 shows material A with an incident velocity striking material B, thereby a stress wave is created in both materials. This is a simplified model of a sandwich element used in calculations.

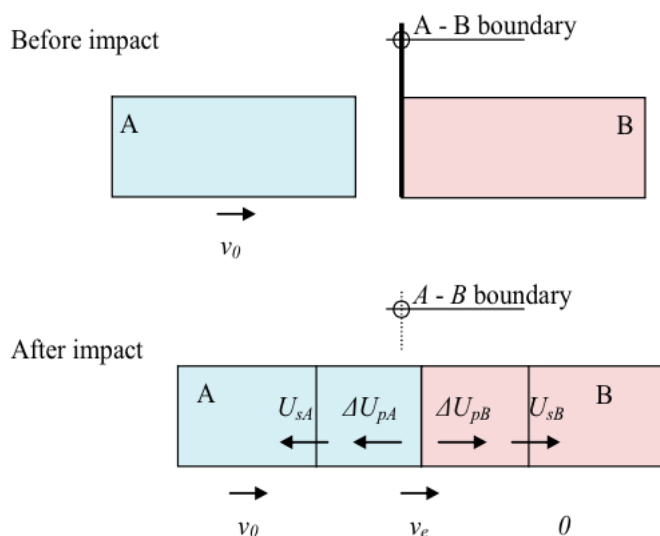

Figure 1.1.1: Example of impact between two materials.

1.2 Purpose

The purpose of this Master's thesis was to increase the knowledge about wave propagation between materials with different properties. The aim was to design a small strengthening structure which decrease the amplitude of the stress wave by combining the theory of wave propagation combined with the theory of transformational elastodynamics.

1.3 Limitations

The literature survey describes various types of waves that may impinge upon a structure. However, only one-dimensional plane elastic stress waves will be considered in the case studies, these plane elastic stress waves are in some sense simpler compared to other types of waves. The material properties used in the case studies are fictional. However, a small study with real material properties is carried out. Furthermore, calculations are only performed on one system, free in one end and fixed on the other end.

1.4 Method

The project consists of two parts, one literature survey and a case study with FE-analysis and hand-calculations. The literature survey will cover the theory behind wave propagation and in addition bring knowledge how to perform hand calculations in order to get accurate results. The FE-analysis is made by means of the software LS-DYNA, which is a code for solving highly non-linear transient problems. In order to verify the results from the FE-analysis, hand calculations are carried out and compared with the results from LS-DYNA. Furthermore, MATLAB is used when the calculations require many iterations to find the results and Mathematica is used in order to find different transformation functions which fulfil specific requirements.

2 Material Behaviour

The materials have an influence on how a structure behaves. There are different kinds of approximations used when analysing the material response, this is done in order to simplify the calculations and the structural analysis. This chapter explains the basic material models often used in structural analysis.

2.1 Elastic material behaviour

An elastic behaviour is defined as the linear relation between stress σ , and strain ε . The constitutive relation between the stress and strain are defined by Hooke's law, see equation (2.1.1) The slope of the curve is characterized as Young's modulus E , which is the resistance to deformation of the material. A typical stress-strain curve is presented in Figure 2.1.1.

$$\sigma = E\varepsilon \quad (2.1.1)$$

The linear relation means that a material undergoing deformation due to loads will return to its original state when the loads are removed. However, this linear relation is only valid for small strains and stresses, larger stresses results in permanent damage to the material. Different materials have different properties for stress and strain, which give a different value for Young's modulus.

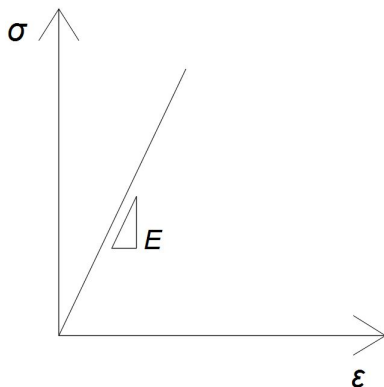

Figure 2.1.1: Stress-strain curve for an elastic material.

2.2 Plastic material behaviour

A plastic deformation is an irreversible action, which means that the elongation or shortening of the material is permanent. There are three important points on the stress strain-curve, the yield limit σ_y , where the material will start to yield, ultimate stress limit σ_u , which is the point of the maximum stress and then fracture occur, see Figure 2.2.1. After the yield limit is reached the material can still take a higher stress, but the deformation will be permanent. This behaviour is called strain hardening. The material will be able to take more load until the ultimate capacity is reached. After that point the material will have large strains which results in a neck in the material, this means that a stress concentration is formed in this neck. When the stresses are too high in this point the material will eventually break. The plastic behaviour for most materials is non-linear which make the analyses

in the plastic zone difficult. If the material is loaded above the yield limit the material parameters and geometry are changed; next time the material is loaded it will not behave in the same manner as before. However, there are simplifications which can be made in order to make calculations easier.

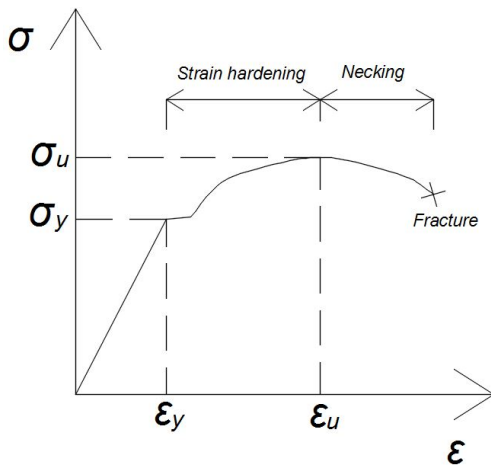

Figure 2.2.1: Real relation between stresses and strains.

One simplification which is commonly used is an ideal plastic material model. The material is then undeformed until the yield limit is reached, see Figure 2.2.2. The model does not take strain-hardening into account and the strains can be infinitely large without fracture, which is not a realistic behaviour.

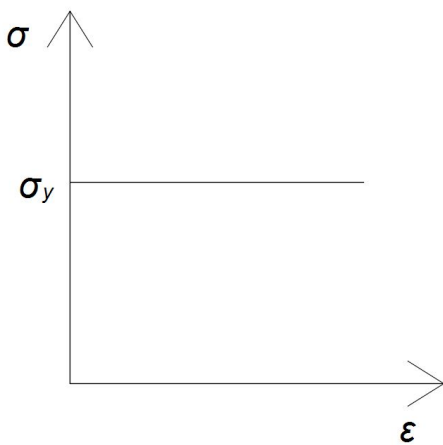

Figure 2.2.2: Ideal plastic relation.

Another material model which is commonly used is a bi-linear approximation. Instead of having a constant value as stress-strain relation, it is now represented with two linear curves with different slopes. The first curve represents the elastic behaviour of the material and is defined until the yield limit. After the yield limit a second curve is defined with a different slope which represents the plastic behaviour, see Figure 2.2.3. This is a more correct model since it takes strain hardening into account.

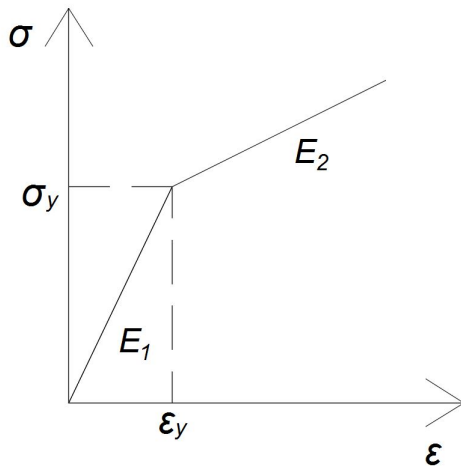

Figure 2.2.3: Stress-strain bi-linear behaviour.

For dynamic analysis it is often more convenient to use strain-rate instead of the strain. Strain rate is the change of strain with time during an impact load which affects the elastic behaviour, as well as the plastic behaviour (Meyer, 1994). High strain rates occur during a short loading time and a low strain rate when the loading time is long (e.g. creep and shrinkage), see Table 2.2.1. The history of the strain rate also affects the plastic behaviour.

Table 2.2.1: Strain rates for different phenomena, data from (Meyer, 1994).

Type of load	Strain rate [s^{-1}]
Creep	$\sim 10^{-8} - 10^{-6}$
Static	$\sim 10^{-5}$
Earthquake	$\sim 10^{-3} - 10^{-2}$
Hard impact	$\sim 1 - 10^1$
Blast	$\sim 10^2 - 10^3$

3 Rigid Body Dynamics

Rigid body dynamics studies the movement of interconnected bodies under action of external forces. Rigid bodies are assumed to not deform, which is an approximation that makes the system easier compared to reality (since no body is perfectly rigid). Partial differential equations which are hard to solve by hand, are not needed to be considered in this present context, for a rigid body system.

3.1 Elastic impact

The behaviour of an elastic impact can be described with a one dimensional system of two bodies A and B, moving straight in the x-direction, see Figure 3.1.1. When the two bodies collide the dynamics of the rigid body system can be defined with the equation of motion. Each body have mass and velocity before the impact and are denoted as m_A, m_B, v_{Ab}, v_{Bb} . If these parameters are known, mass and velocity of the bodies after impact can be calculated with equation (3.1.1) and (3.1.2) (subscript a stands for after impact and b for before impact) (Leppänen, 2012).

$$v_{Aa} = \frac{v_{Bb}(m_A - m_B) + 2v_{Bb}m_B}{m_A + m_B} \tag{3.1.1}$$

$$v_{Ba} = \frac{2v_{Ab}m_A + v_{Bb}(m_B - m_A)}{m_A + m_B} \tag{3.1.2}$$

Before impact



After impact

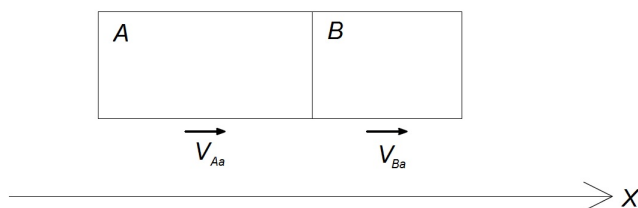

Figure 3.1.1: Elastic impact of body A and B.

Three different cases in this example can occur:

- $m_A < m_B$, means that after impact body A moves with a velocity to the left
- $m_A = m_B$, motion of body A stops and all momentum is transferred into body B, which moves to the right
- $m_A > m_B$, both bodies moves to the right, but body B moves with a higher velocity

The velocity of body A cannot become higher after impact. Body B cannot get a negative velocity (Leppänen, 2012).

3.2 Plastic impact

A plastic impact means that two bodies (from the last example) will get stuck together after impact, see Figure 3.2.1. When the two bodies collide they will get stuck together and move away with the same velocity. With equation (3.2.1) the velocity for plastic impact can be obtain (Leppänen, 2012).

$$v_a = \frac{m_A v_{Ab} + m_B v_{Bb}}{m_A + m_B} \quad (3.2.1)$$

Before impact



After impact

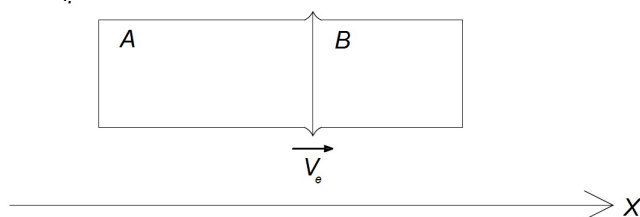

Figure 3.2.1: Plastic impact of body A and B.

In some cases the materials can be somewhere between plastic and elastic behaviour, this can be determined by using Newtons law of restitution, see equation (3.2.2).

$$e = \frac{c^+}{c^-} = \frac{v_{Ba} - v_{Aa}}{v_{Ab} - v_{Bb}} \quad (3.2.2)$$

where c^+ and c^- are the normal components of relative velocity at the contact point before and after collision of the two bodies. When these parameters vary the e -value can vary from 0 to 1, which follows:

- 0 = elastic impact
- 1 = full plastic impact

In order to get accurate results for an impact between or close to elastic or plastic behaviour, the value obtained from Newton's law of restitution e , can be inserted into the equation (3.2.1) and written as in equation (3.2.3) and (3.2.4) (Leppänen, 2012):

$$v_{Aa} = \frac{m_A e (v_{Ab} - v_{Bb}) + m_A v_{Ab} + m_B v_{Bb}}{m_A + m_B} \quad (3.2.3)$$

$$v_{Ba} = \frac{m_B e (v_{Bb} - v_{Ab}) + m_A v_{Ab} + m_B v_{Bb}}{m_A + m_B} \quad (3.2.4)$$

4 Stress Waves

Waves which cause deformation in a material are often called stress waves. Stress waves can be created from several different sources, for example impact between materials, explosions and earthquakes. The difference between static loading and impact loading in terms of stresses is huge (Leppänen, 2012). The variance in stress levels is caused by the time difference when the load is applied, e.g. a static load acts on the structure for a long time. The dynamic loading acts on the structure for a very short time span (microseconds) with a magnitude much higher than for the static case. The short impulse loading causes the material to behave differently than normal, which makes this phenomena hard to analyse and the mathematics quickly becomes complex.

As mentioned before, classic rigid body dynamics describes the impact between bodies. If a stress wave is created it is hard to solve it by the traditional rigid body dynamics theory (Leppänen, 2012). Therefore, instead of analysing the problem in terms of kinetic energy, it is possible to analyse the problem in terms of wave propagation. The wave which propagates through the material can cause both plastic and elastic deformations, if the velocity of the impact is high a shock wave is created, which is a dangerous wave that can cause large deformations.

4.1 Different kinds of stress waves

There are different kinds of stress waves which can propagate through a material. They are characterised by the motion of the particles in the material (Meyer, 1994). Common stress waves are presented below and in following sections.

- Longitudinal waves, also called pressure waves (P-wave)
- Transverse waves, also called shear waves (S-wave)
- Rayleigh waves, a type of surface wave

4.1.1 Longitudinal waves

A longitudinal wave is created when the particles in the material are moving in the same direction as the incident wave. As seen in Figure 4.1.1 the particles come closer to each other and cause compressive stresses in the material. Furthermore, tensile stresses may occur when a wave propagate through a material, the particles then move away from each other (Meyer, 1994). Depending on the boundary conditions a wave can change from a compression wave to a tension wave when the wave hit the boundary (Macaulay, 1987). For materials which have different properties in compression/tension this phenomena can be important, for example a tensile wave in concrete, which is weak in tensile, can cause the concrete to spall on the reflected surface.

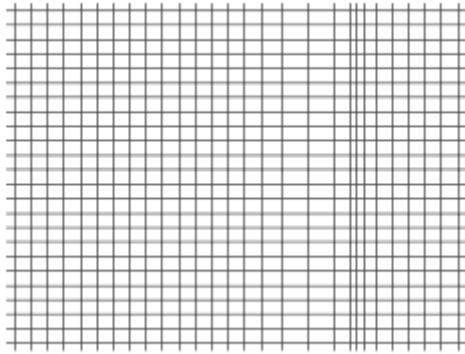

Figure 4.1.1: Plane longitudinal wave.

4.1.2 Transverse waves

A transverse wave is created when the particles in the material are moving perpendicular to the wave front, see Figure 4.1.2. The transverse waves cause shear stresses in the material which the waves propagate through (Meyer, 1994). Therefore, the wave is dangerous for a material with low shear modulus.

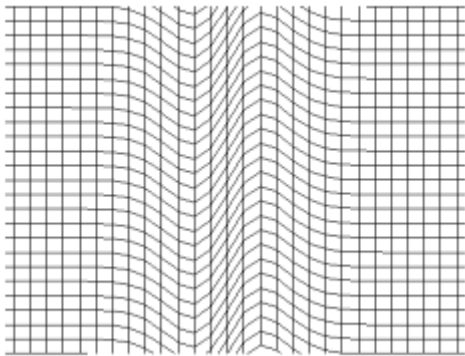

Figure 4.1.2: Plane transverse wave.

4.1.3 Rayleigh waves

A Rayleigh wave is a destructive wave that acts on the surface on the material. The Rayleigh wave propagates in an elliptical counter clockwise way, which results in a up- and down motion combined with a back and forth motion, see Figure 4.1.3 (Meyer, 1994). This behaviour makes this wave destructive, since the amplitude of the wave decreases a lot slower than other waves amplitude. The wave has a high energy on the surface but as it propagate inwards in the material the energy of the wave decays exponentially.

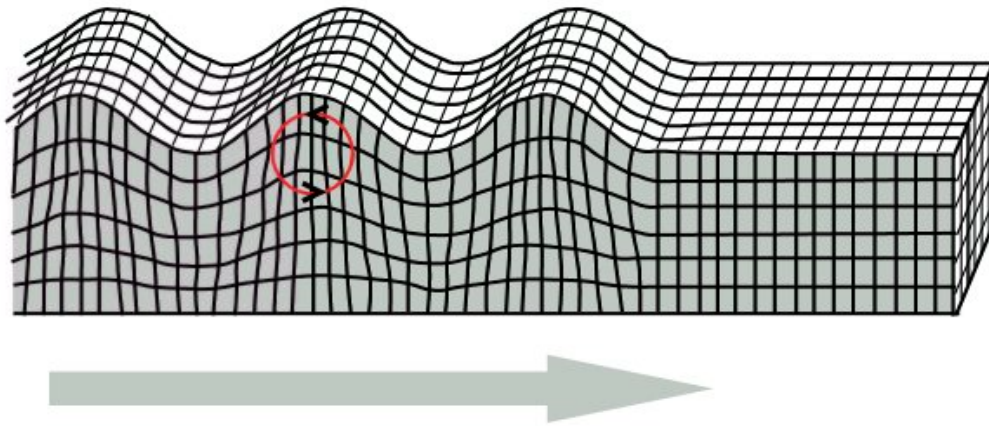

Figure 4.1.3: Picture of a Rayleigh wave. The wave is elliptical and not circular as in the figure.

4.2 Elastic stress waves

An elastic stress wave is created when the impact velocity is low; this implies that stresses in the material are below the yield strength. This means that there will not be any permanent damage to the material.

It is not only the motion of the particles that differentiate the waves; the propagation velocities are different for different waves and materials. The velocity of an elastic wave is determined by Young's modulus, or the shear modulus G , depending on which type of wave propagate through the material (Macaulay, 1987). The density ρ , is also an important material parameter. Different wave velocities for some common materials can be seen in Table 4.2.1. As seen in the table there is a small difference between the velocities for steel, aluminum and concrete, even though there is a large difference between the densities and Young's modulus. Another interesting value in Table 4.2.1 is the wave velocity in the air, it is very low compared to solid materials. A transversal wave cannot travel through air since the air cannot take any shear stresses.

Table 4.2.1: Wave velocities in common materials, data taken from (Macaulay, 1987), wave velocity for concrete calculated by author.

	Elastic wave velocities (m/s)						
	Steel	Aluminium	Iron	Copper	Glass	Concrete C30/37	Air
Longitudinal, c	5000	5000	3900	3650	5250	3530	340
Transversal, c_T	3200	3050	2450	2250	3200	2230	-

4.2.1 Analysis of elastic stress waves

Propagating waves are complex phenomena which quickly results in complex models and mathematics. An elastic wave is a rather simple case since the material behaves linearly. Consider an impact between two rods, one rod in rest and one approaching with a velocity v , see Figure 4.2.1, it is possible to

derive the wave equation for the one-dimensional case (Leppänen, 2002). This analysis is not valid for plastic waves or shock waves since the material behaviour is no longer linear.

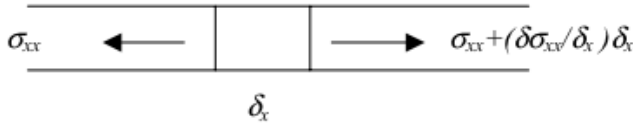

Figure 4.2.1: One-dimensional model of wave propagating through a rod (Leppänen, 2002).

By considering Newton's second law $\sum F = ma$, constitutive laws, equilibrium and compatibility of the rod, see Figure 4.2.1, it is possible to derive the one-dimensional wave equation (Leppänen, 2002). Using Newton's second law the partial differential equation (4.2.1) can be obtained.

$$A \frac{\partial \sigma_{xx}}{\partial x} \delta x = \rho A \delta x \frac{\partial^2 u}{\partial t^2} \quad (4.2.1)$$

A is the cross-sectional area, ρ is the density of the rods, σ is the compressive stress, $\partial \sigma / \partial x$ is the stress variation in the specimen and $\partial^2 u / \partial t^2$ is the acceleration where u is the displacement in x-direction (Leppänen, 2002) and (Macaulay, 1987). The constitutive relation, Hooke's law is defined in equation (4.2.2).

$$\sigma_{xx} = E \epsilon_{xx} \quad \text{where} \quad \epsilon_{xx} = \frac{\partial u}{\partial x} \quad (4.2.2)$$

By using equation (4.2.2) in equation (4.2.1), it is possible to formulate the final form of the wave equation.

$$\rho \frac{\partial^2 u}{\partial t^2} = E \frac{\partial^2 u}{\partial x^2} \quad (4.2.3)$$

Equation (4.2.3) can be rewritten as equation (4.2.4).

$$\frac{\partial^2 u}{\partial t^2} = c^2 \frac{\partial^2 u}{\partial x^2} \quad (4.2.4)$$

c is the velocity of the propagating wave. In equation (4.2.5) the expression for longitudinal c and transversal wave velocity c_T , is stated.

$$c = \pm \sqrt{\frac{E}{\rho}} \quad \text{and} \quad c_T = \pm \sqrt{\frac{G}{\rho}} \quad (4.2.5)$$

The general solution to equation (4.2.4) is presented in equation (4.2.6) (Macaulay, 1987).

$$u = f(x - c_0 t) + F(x + c_0 t) \quad (4.2.6)$$

The solution represents two waves propagating in the opposite direction with equal wave velocity c_0 . f and F describe the shape of the two waves which propagate in the material (Meyer, 1994). Both f

and F are dependent on the initial conditions of the system. If there is only one wave propagating in the material F can be set to zero.

In two- or three dimensions the mathematics becomes more complex. However, for the linear elastic case the general partial differential equation for three dimensions can be written as in equation (4.2.7).

$$\frac{\partial \sigma_{ij}}{\partial x_j} = \rho \frac{\partial^2 u_i}{\partial t^2} \quad (4.2.7)$$

The equation system, (4.2.7), will result in the wave equation when the stress is replaced with the strain (Meyer, 1994). To replace the stress with strain the generalized Hooke's law for an isotropic material in a triaxial state of stress is used. The propagation of both transversal and longitudinal waves can be derived from this expression.

The longitudinal and transversal wave velocities in three dimensions can be described with equation (4.2.8).

$$c = \sqrt{\frac{E(1-\nu)}{(1+\nu)(1-2\nu)\rho}} \quad \text{and} \quad c_T = c_L \sqrt{\frac{(1-2\nu)}{2(1-\nu)}} \quad (4.2.8)$$

The velocity equations are slightly different from the one-dimensional formulation, the difference is that the velocity also depends on Poisson's ratio because the stress waves also generate shear stresses in the material (Macaulay, 1987).

4.2.2 Energy loss and damping

When a plane one dimensional stress wave travels through a linear elastic material the stress amplitude of the wave is constant. However, in reality, the material will absorb energy during the propagation of the wave. This causes an energy loss and the stress amplitude decrease. An example of this phenomenon is an impact on a long steel rod which will create a stress wave. If the rod is fixed on the other side the wave will reflect and in time the stress wave will decay to zero as a result of the energy loss.

Energy loss can be treated as a damping mechanism which can be included in the numerical analysis in different ways. One way to consider damping is to choose the damping force to be proportional to the particle velocity, this is called viscous damping. Hysteric damping, sometimes known as structural damping, is another way to treat material damping, where the damping force varies with the displacement, but in phase with the velocity. However, in some cases the damping is negligible because during an impulse load the damping has a small effect in the maximal deformation in the first oscillation. Furthermore, the length of the medium can be too short and the damping is therefore neglected (Macaulay, 1987).

4.3 Elastic wave reflection

When a wave goes from one material into another, the wave will be reflected and refracted at the boundary of the material. The wave can be divided into three parts, incident wave (I), transmitted wave (T), and a reflected wave (R) (Meyer, 1994). These phenomena occur because the second medium has different acoustic impedance and the system wants to be in momentum balance. The acoustic impedance is how much movement the wave affect the material, and if the impedance differs between the materials a reflected wave is created in order to achieve balance (Lempriere, 2002). A greater difference in acoustic impedance between materials results in a larger reflected wave and a less transmitted wave. Furthermore, the sum of the reflected wave and transmitted wave should be equal to the incident wave. The acoustic impedance is the product of the density, and the elastic wave velocity, of the material, see Figure 4.3.1.

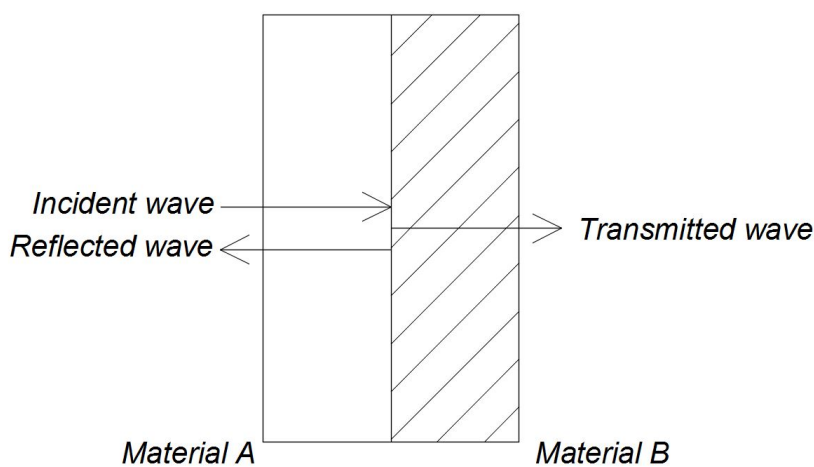

Figure 4.3.1: Incident wave, reflected waves, transmitted wave.

4.3.1 Impact between two rods and elastic wave reflection

It has been shown with rigid body dynamics how two bodies behave upon impact. However, it is complicated to solve these problems with this theory since there is no information about the inner energy of the system. Therefore, a more convenient way to solve the problem is to use the theory of wave propagation. A derivation of this theory is presented in this section in order to get an understanding how these problems can be treated.

Figure 4.3.2 describes how the particle- and wave velocity travels through the material upon impact. The wave velocity is always higher than the particle velocity U_p . After impact the incident wave is divided in two new waves, one reflected which goes back in to the first material and one transmitted wave which propagate into the next material.

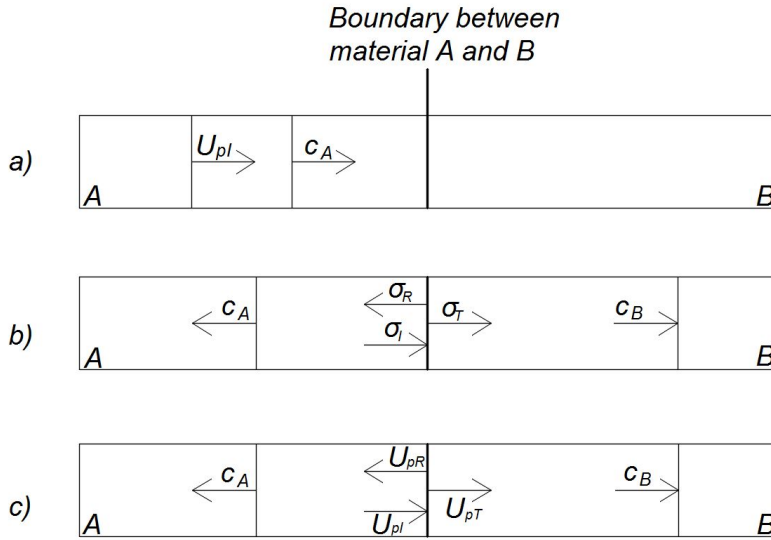

Figure 4.3.2: Impact between two rods, a) Incident wave b) Reflected and transmitted stresses c) Reflected and transmitted particle velocities.

The expression for the incident, reflected and transmitted stress and particle velocity are derived from the impulse equation, see equation (4.3.1). The impulse I , is equal to the change of momentum in the system (Leppänen, 2012).

$$I = \int_0^t F(t)dt = m \int_0^v dv = mv_e - mv_0 \quad (4.3.1)$$

Before the wave has passed in any given point the velocity in that point is equal to zero. This means that when the wave has passed this given point the change in particle velocity is equal to the particle velocity U_p , this can be written as in equation (4.3.2).

$$I = m\Delta U_p = mU_p \quad (4.3.2)$$

By using Navier's formula and by writing the mass as $m = \rho V = \rho A dx$. Equation (4.3.2) can be rewritten. Equation (4.3.2) can then be stated as in equation (4.3.3).

$$\sigma A dt = \rho A dx U_p \quad (4.3.3)$$

Solving σ in equation (4.3.3), results in equation (4.3.4).

$$\sigma = \rho \frac{dx}{dt} U_p = \rho c U_p \quad \text{and} \quad c = \frac{dx}{dt} \quad (4.3.4)$$

As seen in equation (4.3.4) the stress no longer depends on the cross-sectional area of the rod, it depends on the density of the material, wave velocity and the particle velocity.

In the one-dimensional case there is no energy loss during propagation of the wave, which means that when the wave goes from material A to material B there is no energy loss. Therefore, the incident and

reflected stress need to be equal to the transmitted stress (Leppänen, 2012). This phenomenon can be written as in equation (4.3.5).

$$\sigma_I + \sigma_R = \sigma_T \quad (4.3.5)$$

The particle velocity needs to fulfil the same condition as the transmitted and reflected stress which results in the statement in equation (4.3.6).

$$U_{pI} + U_{pR} = U_{pT} \quad (4.3.6)$$

The acoustic impedance is often known, by using the equations above it is possible to calculate the stress or the particle velocity for the system in Figure 4.3.2 (Macaulay, 1987).

From equation (4.3.4), combined with the known acoustic impedance it is possible to calculate the incident, reflected and transmitted particle velocity for the system in Figure 4.3.2.

$$U_{pI} = \frac{\sigma_I}{\rho_{ACA}} \quad (4.3.7)$$

$$U_{pR} = \frac{-\sigma_R}{\rho_{ACA}} \quad (4.3.8)$$

$$U_{pT} = \frac{\sigma_T}{\rho_{BCB}} \quad (4.3.9)$$

The incident, transmitted and reflected stress can be calculated by using equation (4.3.7), (4.3.8) and (4.3.9) in equation (4.3.2).

$$\frac{\sigma_I}{\rho_{ACA}} - \frac{\sigma_R}{\rho_{ACA}} = \frac{\sigma_T}{\rho_{BCB}} \quad (4.3.10)$$

From equation (4.3.10), it is easy to see that the stresses in the material are highly dependent on the acoustic impedance, (ρc). It is also possible to rewrite the expression so that the reflected and transmitted stress is a function of the incident stress, see equation (4.3.11) and (4.3.12).

$$\sigma_T = \frac{2\rho_{BCB}}{\rho_{ACA} + \rho_{BCB}} \cdot \sigma_I \quad (4.3.11)$$

$$\sigma_R = \frac{\rho_{BCB} - \rho_{ACA}}{\rho_{BCB} + \rho_{ACA}} \cdot \sigma_I \quad (4.3.12)$$

4.3.2 Common cases

There are some common cases of reflections for certain boundary conditions, they will always behave in the same way. If the wave encounters a free surface, then ρ_{BCB} is equal to zero (Meyer, 1994).

$$\sigma_T = 0 \cdot \sigma_I \quad (4.3.13)$$

From equation (4.3.13) it is easy to see that no stress is transmitted to the surroundings, the reflected stress will be equally large as the incident stress and it changes sign, see equation (4.3.14). The change of sign means that the stress goes from a compression wave to a tensile wave or vice versa.

$$\sigma_R = -1 \cdot \sigma_I \quad (4.3.14)$$

Another common case is when the wave hit a fixed boundary. This means that ρ_{BCB} goes toward infinity.

$$\sigma_T = \frac{2\rho_{BCB}}{\rho_{ACA} + \rho_{BCB}} \cdot \sigma_I \approx 2 \cdot \sigma_I \quad (4.3.15)$$

Equation (4.3.15) shows that with fixed boundary the transmitted stress will be twice the incident stress which hits the boundary. Equation (4.3.16) shows that the reflected stress will be the same as the incident stress. It does not change sign which implies, if it is a compression wave that hit the boundary, a compression wave will reflect back. This is also valid for tensile waves.

$$\sigma_R = \frac{\rho_{BCB} - \rho_{ACA}}{\rho_{BCB} + \rho_{ACA}} \cdot \sigma_I \approx 1 \cdot \sigma_I \quad (4.3.16)$$

An interface between two different materials can be considered less or more as a fixed boundary depending on the material properties. Which means that the transmitted and reflected stress will behave differently for different materials. The particle velocity behaves similar as the stress wave and can be derived in the same manner as the stresses (Meyers, 1994).

4.3.3 Lagrange diagrams - Graphical description of reflections

Lagrange diagrams are an easy way to graphically show how a one-dimensional wave propagates through a material. The horizontal axis represents the coordinates of the stress wave front in the material and vertical axis is the time variable. Different impact phenomena can be illustrated, for example a rod collides with a wall or two rods collide with each other. Figure 4.3.3 illustrates an incident rod A travelling with a velocity v_0 , in the x-direction against a second rod B with same length and material properties. At first the stress is zero but, at t_0 , they collide and a compression wave is created in each rod that travels until it reach the free surface, at time t_1 , it reflects as a tension wave and generates a new particle velocity as it simultaneously moves in the other direction. This will continue and adding more time steps t , in which reflections will occur and make waves change between compression and tension (Zukas, 1990).

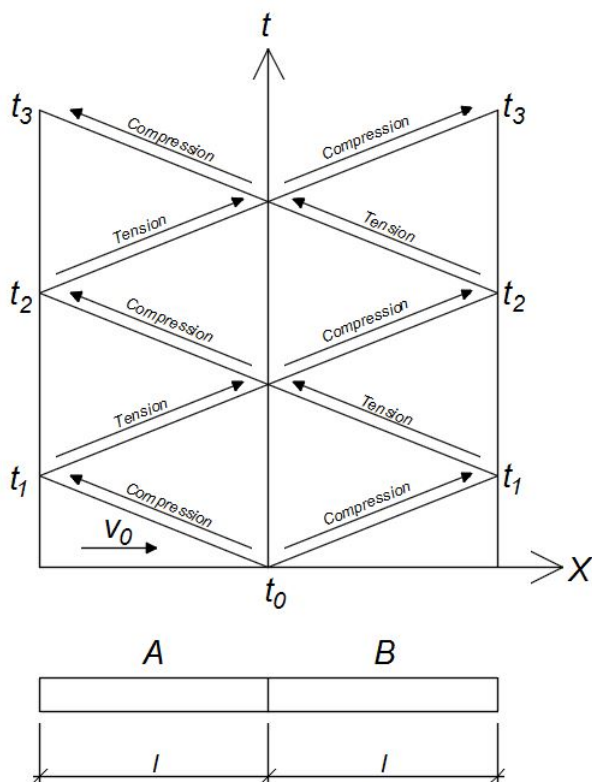

Figure 4.3.3: Lagrange diagram for the example above.

4.3.4 Example of an elastic impact

The theory of an elastic impact has been described in recent sections. This section will show an example of an elastic impact on a rod, with its equations, assumptions and hand calculations.

Figure 4.3.4 illustrates a rod with two different homogeneous materials, steel and aluminum, see material parameters in Table (4.3.1). The rod is fixed at one end and free at the other end and subjected to a force (500 N) which represent the impact load impulse. The materials have the same length and cross-section area (645 mm^2).

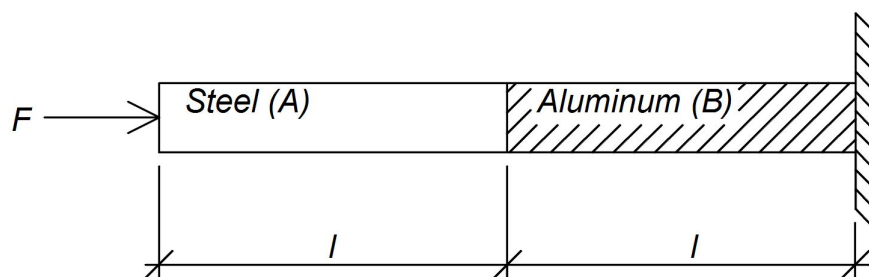

Figure 4.3.4: Rod subjected to a force that represents the impact.

The two materials have different impedance, which determine the amplitude of transmitted and reflected stresses. This means higher impedance difference between materials result in a greater reflection wave and a lower transmitted wave. As mentioned before the reason of this is because the two materials have to achieve equilibrium.

First the stresses will be calculated from the equation (4.3.11) and (4.3.12). After the stresses have been determined the particle velocity can be calculated from equation (4.3.7), (4.3.8) and (4.3.9).

Table 4.3.1: Material parameters for steel and aluminium.

	Steel (A)	Aluminum (B)	Unit
Density, ρ	7850	2700	[kg/m ³]
Young's modulus, E	210	69	[GPa]
Wave velocity, c	5172	5055	[m/s]
Impedance, ρc	234	70.3	[kg/sm ²]

$$\sigma_I = \frac{F}{A} = 0.77 \text{ MPa} \quad (4.3.17)$$

$$\sigma_T = \frac{2\rho_{BCB}}{\rho_{ACA} + \rho_{BCB}} \sigma_I = 0.39 \text{ MPa} \quad (4.3.18)$$

$$\sigma_R = \frac{\rho_{BCB} - \rho_{ACA}}{\rho_{BCB} + \rho_{ACA}} \sigma_I = -0.38 \text{ MPa} \quad (4.3.19)$$

$$U_{pI} = \frac{\sigma_I}{\rho_A C_A} = 0.019 \text{ m/s} \quad (4.3.20)$$

$$U_{pR} = \frac{-\sigma_R}{\rho_A C_A} = 9.4 \cdot 10^{-3} \text{ m/s} \quad (4.3.21)$$

$$U_{pT} = \frac{\sigma_T}{\rho_B C_B} = 0.029 \text{ m/s} \quad (4.3.22)$$

Because $\rho_B C_B < \rho_A C_A$ the reflected wave will have the same sign as the incident wave. It can also be observed that the transmitted wave has increased and the sum of the reflected and transmitted waves are equal to the incident wave. This means that the system has momentum balance.

If three or even four materials have an increase of impedance in each layer, the procedure would just repeat itself and as a result the transmitted wave in the layer would increase.

If the materials change places, hence aluminium will be material (A) and steel will be material (B), the wave velocity will be the opposite. The total stress and deflection will still be the same.

4.4 Transformational elastodynamics

With the theory of transformational elastodynamics it is possible to hide or redirect stress waves in a solid material¹. The concept is that the wave does not feel the object which the wave hit or passes through; or just have a smaller impact. In structural engineering this is a very interesting concept, since it then can be possible to build protection walls which are very thin but still have the same structural response as a massive concrete wall. This concept can be widened to a lot of different areas such as helmets, cars, etc.; especially where space is a large factor.

This section will show how the theory of elastodynamics can be used in one-dimension. In two- and three dimensions the wave can be guided around an object which not is possible in one-dimension. Furthermore, in the section it is also presented how the material parameters can be derived in order to receive the desirable behaviour of the structure that will be designed.

4.4.1 Derivation of equations

The main advantage by using the theory of transformational elastodynamics in one-dimension is that it is possible to create small structures which have the same dynamic response as a much larger structure. Figure 4.4.1 presents two one-dimensional systems (system A and system B) with varying material properties (E, ρ), through the specimens. The aim of this method is to find material properties for specimen B so that the specimen has the same dynamic response as specimen A.

The systems are hit by an incident wave at $t = 0$. The thickness of specimen A is equal to a and the thickness of specimen B is equal to \hat{a} , where \hat{a} is smaller than a . The coordinate system is changed

¹Peter Olsson (Professor, Chalmers University of Technology)

from x to \hat{x} between the systems. Boundary conditions are equal for both the system where the end to the left is free and the end to the right is fixed. The materials properties in specimen A are E_0 and ρ_0 and for specimen B they are still unknown.

The height of the specimens in Figure 4.4.1 is considered as infinite since it is only the variation along the x -axis that is of interest. The incident wave hit the specimen without any inclination.

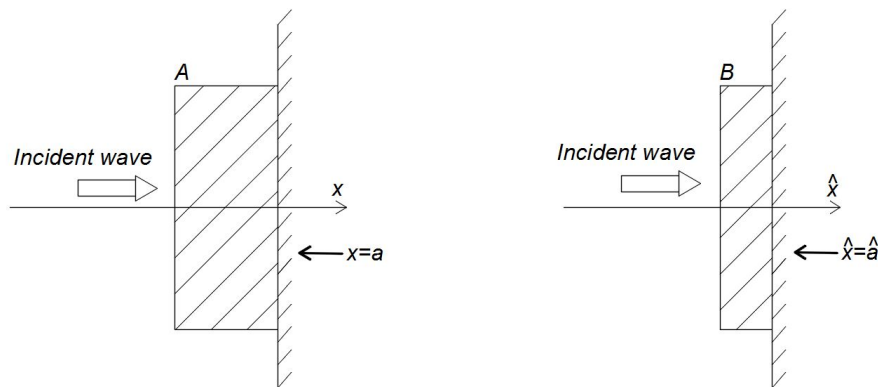

Figure 4.4.1: Two systems with varying material properties and different lengths.

The wave equation for the system A is presented in equation (4.4.1) and the wave equation for system B is presented in equation (4.4.2).

$$\frac{\partial}{\partial x} \left(E(x) \frac{\partial u(x,t)}{\partial x} \right) - \rho(x) \frac{\partial^2 u(x,t)}{\partial t^2} = 0 \quad (4.4.1)$$

$$\frac{\partial}{\partial \hat{x}} \left(\hat{E}(\hat{x}) \frac{\partial \hat{u}}{\partial \hat{x}} \right) - \hat{\rho}(\hat{x}) \frac{\partial^2 \hat{u}}{\partial \hat{t}^2} = 0 \quad (4.4.2)$$

The boundary and initial conditions are the same for both the systems; they need to be the same in order to have the same dynamic response. The conditions are presented in equation (4.4.3)-(4.4.6).

$$E(0) \frac{\partial u(0,t)}{\partial x} = h(t), \quad t \geq 0 \quad (4.4.3)$$

$$u(a,t) = 0, \quad t \geq 0 \quad (4.4.4)$$

$$u(x,0) = 0, \quad 0 \leq x \leq a \quad (4.4.5)$$

$$\frac{\partial u(x,0)}{\partial t} = 0, \quad 0 \leq x \leq a \quad (4.4.6)$$

The transformation from the x coordinate to \hat{x} coordinates for any point in the system can be written as:

$$\hat{x} = \psi(x) \quad (4.4.7)$$

$$x = \psi^{-1}(\hat{x}) \quad (4.4.8)$$

The expressions in equation (4.4.7) and (4.4.8) can be derived using the chain rule, see equation (4.4.9)

$$\frac{\partial}{\partial x} = \frac{\partial \hat{x}}{\partial x} \frac{\partial}{\partial \hat{x}} = \psi'(\psi^{-1}(\hat{x})) \frac{\partial}{\partial \hat{x}} = \beta(\hat{x}) \frac{\partial}{\partial \hat{x}} \quad (4.4.9)$$

Where $\beta(x)$ is equal to:

$$\beta(x) = \psi'(\psi^{-1}(\hat{x})) \quad (4.4.10)$$

$\psi(x)$ is an almost arbitrary function, it needs to fulfil $\psi(a) = \hat{a}$ and $\psi(\hat{a}) = a$. The function needs to be invertible and sufficiently differentiable together with its inverse for all points in the system. Apart from these requirements the function can be chosen freely ².

The differential equation (4.4.1), for the first system can now be rewritten in terms of \hat{x} , see equation (4.4.11).

$$\frac{\partial}{\partial \hat{x}} \left(E(\psi^{-1}(\hat{x})) \beta(\hat{x}) \frac{\partial u(\psi^{-1}(\hat{x}), t)}{\partial \hat{x}} \right) - \frac{\rho(\psi^{-1}(\hat{x}))}{\beta(\hat{x})} \frac{\partial^2 u(\psi^{-1}(\hat{x}), t)}{\partial t^2} = 0 \quad (4.4.11)$$

From equation (4.4.11) it is possible to see the relation between the original material properties for system A and the new properties for system B. The material properties for system B can be calculated using equation (4.4.12) and (4.4.13). It can also be noticed that the displacements for both systems will be equal.

$$\hat{E}(\hat{x}) = \beta(\hat{x}) \cdot E(\psi^{-1}(\hat{x})) \quad (4.4.12)$$

$$\hat{\rho}(\hat{x}) = \frac{1}{\beta(\hat{x})} \cdot \rho(\psi^{-1}(\hat{x})) \quad (4.4.13)$$

From these expressions above it is possible to transform the first system to infinite number of systems. The new system needs to fulfil the same boundary and initial conditions as for the original system. With these requirements fulfilled the dynamic response is the same for both systems. \hat{a} and a are chosen as arbitrary. The transformation works in both ways, which means that this concept can also be used to make the structure thicker than the original design. Furthermore, this also means it is theoretical possibility to make the transformed structure infinitely thin, but in reality there is no material properties which can fulfil the requirements for that transformation.

²Peter Olsson (Professor Chalmers University of Technology)

4.4.2 Example of finding material properties for a system with constant material properties

The material properties of the system are defined as Young's modulus equal to E_0 , and the density equal to ρ_0 . The aim with the calculations is to find new material properties which can be used in a rod half of the original size. The transformation function is chosen freely and is presented in equation (4.4.14) and the inverse in equation (4.4.15).

Figure 4.4.2 shows two rods, the one to the left (rod A) is 1 meter long and the one to the right (rod B) is 0.5 meter long, the aim is to find material properties (E and ρ) so the shorter rod behaves exactly the same as the longer rod. Rod A have constant material properties which are E_0 and ρ_0 .

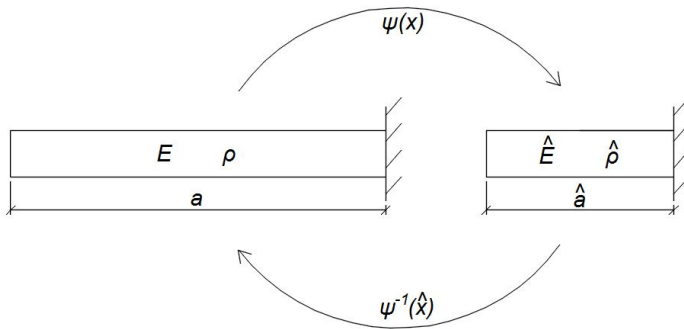

Figure 4.4.2: Transformation of a rod with constant material properties.

The transformation function is chosen as a linear function, see equation (4.4.14). $\psi^{-1}(x)$ is presented in equation (4.4.15), which is needed in order to calculate $\beta(x)$. The inverse function of ψ can also be used to transform the material properties to its original state.

$$\psi(x) = \frac{\hat{a}}{a} \cdot x \quad (4.4.14)$$

$$\psi^{-1}(\hat{x}) = \frac{a}{\hat{a}} \cdot \hat{x} \quad (4.4.15)$$

Using equation (4.4.9) and the fact that a is equal to 1 meter and \hat{a} is equal to 0.5 meter, β can be determined and it is presented in equation (4.4.16). $\beta(x)$ is needed in order to determine Young's modulus and density for the small rod.

$$\beta(x) = \frac{\hat{a}}{a} = \frac{0.5}{1} \quad (4.4.16)$$

When β is known it is possible to find the new material properties for the second system, using equation (4.4.12) and (4.4.13). The results are shown in equation (4.4.17) and (4.4.18).

$$\hat{E}(\hat{x}) = \beta(\hat{x}) \cdot E(\psi^{-1}(\hat{x})) = 0.5E_0 \quad (4.4.17)$$

$$\hat{\rho}(\hat{x}) = \frac{1}{\beta(\hat{x})} \cdot \rho(\psi^{-1}(\hat{x})) = 2\rho_0 \quad (4.4.18)$$

The wave velocity for the new system is then:

$$\hat{c} = \sqrt{\frac{0.5E_0}{2\rho}} = \frac{1}{2} \sqrt{\frac{E_0}{\rho_0}} \quad (4.4.19)$$

For the original system the wave velocity is equal to:

$$c = \sqrt{\frac{E_0}{\rho_0}} \quad (4.4.20)$$

This shows that the wave velocity is half for the smaller rod and it will still have the same dynamic response as the original rod. It can also be confirmed that all ρ and E which fulfil the requirement of halving the velocity will work for the transformation. This is controlled by the transformation function and by changing it, the material parameters can be very different from the ones here. All the results from this example are presented in Chapter 7.

4.5 Plastic stress wave

For static loading plastic deformation will occur if the material starts to yield, this is also the case for dynamic loading. This means that when a dynamic pulse with an amplitude effect the stress in the material, forcing it to reach its elastic limit, the material starts to yield and the plastic behaviour starts (Meyer, 1994). This behaviour will create deformations of the (ductile solid) material, which can vary with stress distribution, previous loading history and strain (Meyer, 1994) and (Macaulay, 1987).

The yield stress varies with the strain rate, which varies with the kind of load that is applied, e.g. a shock wave results in very high strain rate, time-dependent behaviour for metals in the elastic-plastic zone is often negligible.

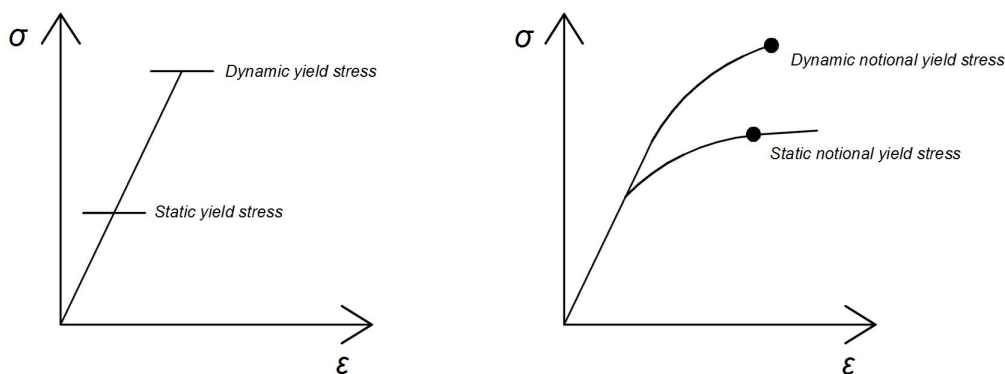

Figure 4.5.1: Graph to the right Dynamic yield stress vs static yield stress, linear behaviour, to the left non-linear behaviour.

4.5.1 Plastic stress waves velocities

For an elastic wave the wave velocity will be constant because in the elastic region the stress-strain relation is linear. However, in the plastic region this is not the case, the stress-strain relationship will instead be non-linear. This means that velocity of plastic waves is lower than elastic waves because the velocity decrease with decreasing slope and strain hardening, see equation (4.5.1).

$$\left(\frac{d\sigma}{d\varepsilon}\right)_{el} > \left(\frac{d\sigma}{d\varepsilon}\right)_{pl} \quad (4.5.1)$$

The plastic wave velocity is stated in equation (4.5.2).

$$c_p = \sqrt{\left(\frac{d\sigma/d\varepsilon}{\rho}\right)} \quad (4.5.2)$$

Materials have a critical velocity, which means that at some point the velocity of the materials is too high and will therefore reach its load carrying capacity and break. For brittle materials this usually occurs in the elastic deformation, and for ductile materials in the plastic deformation.

5 Shock Waves

A shock wave travels with a supersonic speed through a medium and a disturbance front (shock front) will be created because higher amplitude of the front travels faster than the lower amplitude region. Compared to other waves (e.g. sound waves) shock waves result in a high amount of pressure during a short period of time and has a nonlinear discontinuous behaviour. The theory of shock waves is restricted to higher pressures and (Meyer, 1994) shows some basic assumptions that can be made:

- A shock front is a surface of discontinuity
- The shear modulus of the material is set to zero
- Gravitational and heat conduction at the shock front are negligible
- No elastoplastic behaviour can occur

Usually a shock wave is created from an explosion or blast, but also from an impact between materials, this means that the energy content drastically changes during a short period of time. The discontinuity from a shock wave will affect pressure, temperature and density in the medium (Johansson, 2012).

5.1 1D-shock wave propagation

A shock wave in one-dimensional configuration is described with the conservation equations and the equation of state, the EOS. Below, a simple example will be explained in order to get an understanding of the theory for the conservation laws of shock waves.

5.1.1 The conservation laws of shock waves

The fundamental shock wave equations are derived from the conservation laws of shock waves and can be described with a thermodynamic system (Lifshitz, 2001). Consider a cylinder with a cross-section area A , contained with gas-pressure P_0 , and a density ρ_0 , see Figure 5.1.1(a). The right side is closed and the left side is attached to a piston. The system is first at rest, at time t_1 , the piston moves, which entails a constant finite velocity U_p , in x-direction. The gas close to the piston becomes in motion and a shock front S , is formed where the shock front velocity U_s , is larger than the particle velocity, moving forward in the x-direction, see Figure 5.1.1(b). Consequently the pressure P , density ρ , and energy intensity E , of the compressed gas are now changed. Note that subscript 0 refers to the initial state ahead of the shock wave. In (Lifshitz, 2001) the conservation laws of shock wave are stated. The three laws are:

- Conservation of mass
- Conservation of momentum
- Conservation of energy

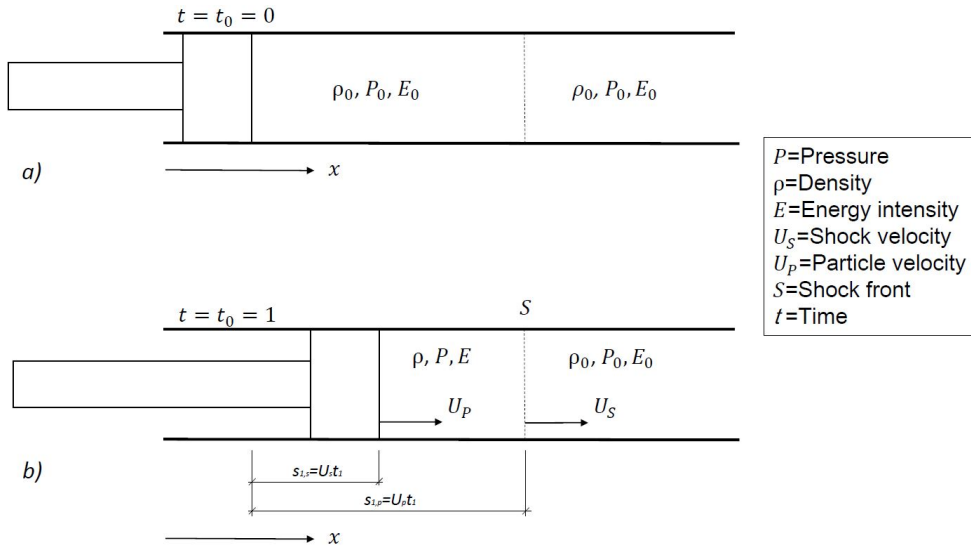

Figure 5.1.1: Thermodynamic system with two steps, (a) before the piston moves and (b) when it has started to move.

Conservation of mass

At time $t = t_1$, the piston has moved a distance of $s_{1,p} = U_p t_1$, and the shock front has moved a distance of $s_{1,s} = U_s t_1$. From this the mass equation can be stated as in equation (5.1.1).

$$\rho_0 U_s = \rho (U_s - U_p) \quad (5.1.1)$$

Note that the law requires that the rate of mass flow through the shock front equals the rate of mass flow exiting the shock.

Conservation of momentum

Momentum is equal to the impulse that is applied to the system and is defined as the product of mass and velocity (Meyer, 1994). The driving force from the piston to the gas causing it to provide a momentum per unit time. From this the equation of momentum can be stated, see equation (5.1.2), where the initial gas-pressure is defined as P_0 and the pressure of its compressed as P .

$$P - P_0 = \rho_0 U_s U_p \quad (5.1.2)$$

$\rho_0 U_s$ is usually called the shock impedance.

Conservation of energy

The external force, which in this case is the compressive work that the piston does to the gas, should be equal to the change of the potential and kinetic energy of the gas. The energy gained by the gas in unit time is the sum of potential energy and the kinetic energy. The equation for conservation of energy is stated in equation (5.1.3).

$$PU_p = \rho_0 U_s \left(\frac{1}{2} U_p^2 + E - E_0 \right) \quad (5.1.3)$$

5.1.2 The equation of state

The equations (5.1.1) - (5.1.3) contains five variables:

- Pressure P
- Particle velocity U_p
- Shock velocity U_s
- Energy E
- Density ρ

In the following example, three equations have been calculated; mass, momentum and energy. To be able to determine all five parameters as a function of one of them, an EOS is needed. It will also be the forth equation to obtain information about the shock wave parameters. For example the EOS can describe the linear relation between the particle velocity and the shock front velocity, as illustrated in equation (5.1.4) (Leppänen, 2012).

$$U_s = c_0 + S_1 U_p + S_2 U_p^2 + \dots \quad (5.1.4)$$

c_0 is the wave velocity for a material at zero pressure with no shear strength, S_1 and S_2 , are empirical parameters (experimentally determined material constants) which can be found in tables. Usually S_2 is equal to zero for metals, therefore equation (5.1.4) can be written as in equation (5.1.5).

$$U_s = c_0 + S_1 U_p \quad (5.1.5)$$

Without any modifications, the equation does not apply for materials that has a high porosity or undergoes phase transformation because it is then no longer linear (Meyer, 1994).

5.1.3 Hugoniot curve and Rayleigh line

The relation between the pressure and density or volume v , behind the shock wave can be described by the Hugoniot curve. U_s and U_p eliminated from the conservation of energy (5.1.3), and density is replaced with volume $v = 1/\rho$, the Hugoniot equation is presented in equation (5.1.6) (Lifshitz, 2001).

$$E - E_0 = \frac{1}{2}(P + P_0)(v - v_0) \quad (5.1.6)$$

The volume has an uncompressed and a compressed state. In order to plot the Hugoniot curve in its plane it is of great importance to know the initial state (v_0, P_0) , of the gas and its EOS.

Figure 5.1.2 shows the Hugoniot curve and as can be seen a line is drawn from (v_0, P_0) to (v, P) , this is called the Rayleigh line. The Rayleigh line is defined as in equation (5.1.7), where the slope of the line shows the discontinuity of pressure and density. This line describes how the state of a medium will change when it has been hit by a shock wave, the change from original pressure and volume (v_0, P_0) of the gas, to its compressed state (v, P) . Higher pressure will result in an increased slope of the Rayleigh line and velocity.

$$\Delta P / \Delta v = -\rho_0^2 U_s^2 \quad (5.1.7)$$

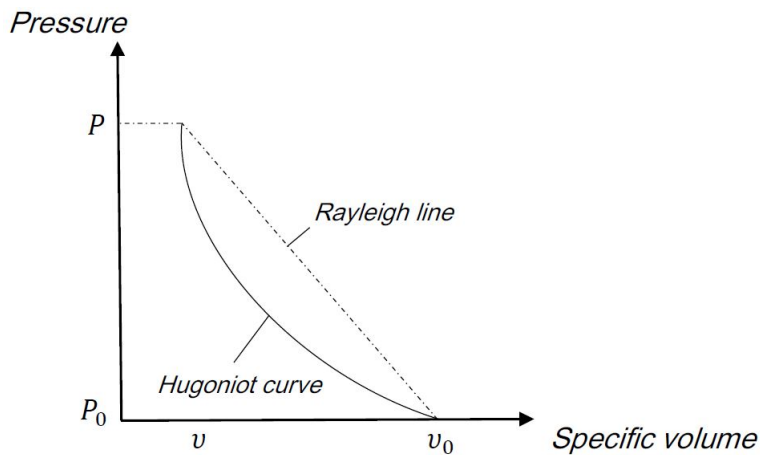

Figure 5.1.2: Hugoniot curve and Rayleigh line.

5.1.4 Example of a plastic impact

As mentioned before, impact is a phenomenon that can create a shock wave. A simple type of impact is planar, where two parallel flat surfaces hits each other simultaneously. In Dynamic behaviour of materials, Meyers has made an example in order to show the calculations of a plastic impact. A projectile (1), is moving with a velocity v , in direction against a body (2), which is at rest, see Figure 5.1.3(a). When the projectile collides with the body, see figure 5.1.3(b), two compressive shock waves are created, one that travels through the body with velocity U_{s2} , and another one travels through the projectile with an velocity of U_{s1} , shown in Figure 5.1.3(c), note that subscripts (1) and (2) refer to the material for the projectile and for the body.

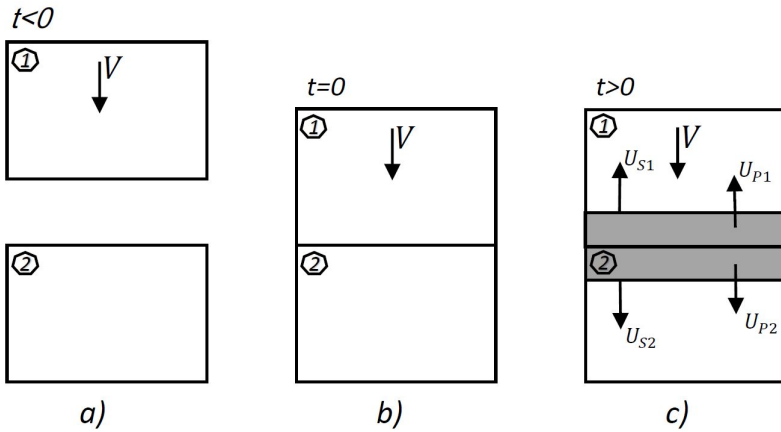

Figure 5.1.3: a) Projectile (1) moving against a body (2), b) collision between the two parts, c) two shock waves move through the two materials.

Before impact the projectile moves with a velocity. Upon impact the particles in the compressed region of the projectile is reduced as the domain of the particle velocity U_{p1} expands, where the particle velocity in the body becomes as in equation (5.1.8).

$$v - U_{p1} = U_{p2} \quad (5.1.8)$$

Equation (5.1.8) can be rewritten as in equation (5.1.9)

$$U_{p1} + U_{p2} = v \quad (5.1.9)$$

Pressure for the projectile P_1 , and the body P_2 , can be determined by using conservation of momentum equation (5.1.2), the pressures are determined by equation (5.1.10).

$$P_1 = \rho_{01} U_{s1} U_{p1} \quad P_2 = \rho_{02} U_{s2} U_{p2} \quad (5.1.10)$$

EOS for the projectile and the body are stated in equation (5.1.11).

$$U_{s1} = c_{01} + S_1 U_{p1} \quad U_{s2} = c_{02} + S_2 U_{p2} \quad (5.1.11)$$

Inserting the EOS into the conservation of momentum, equation (5.1.12) and (5.1.13) can be derived.

$$P_1 = \rho_{01}(c_{01} + S_1 U_{p1})U_{p1} \quad (5.1.12)$$

$$P_2 = \rho_{02}(c_{02} + S_2 U_{p2})U_{p2} \quad (5.1.13)$$

Set U_{p1} as a function of U_{p2} and by substituting $v - U_{p2}$, for U_{p1} an equation with only one unknown U_{p2} will be obtained in equation (5.1.14).

$$P_1 = \rho_{01}c_{01}(v - U_{p2}) + \rho_{01}S_1(v - U_{p2})^2 \quad (5.1.14)$$

The pressure in projectile and the body is assumed to be the same, the central membrane will move until pressure is equilibrated, see equation (5.1.15).

$$P_1 = P_2 \quad (5.1.15)$$

Insert (5.1.14) and (5.1.13) into (5.1.15) results in equation (5.1.16).

$$U_{p2}^2(\rho_{02}S_2 - \rho_{01}S_1) + U_{p2}(\rho_{02}c_{02} + \rho_{01}c_{01} + 2\rho_{01}S_1v) - \rho_{01}(c_{01}v + S_1v^2) = 0 \quad (5.1.16)$$

By solving U_{p2} in equation (5.1.16), it is possible to write equation (5.1.17).

$$U_{p2} = \frac{-(\rho_{02}c_{02} + \rho_{01}c_{01} + 2\rho_{01}S_1v) \pm (\Delta)^{1/2}}{2(\rho_{02}S_2 - \rho_{01}S_1)} \quad (5.1.17)$$

Where Δ is equal to:

$$\Delta = (\rho_{02}c_{02} + \rho_{01}c_{01} + 2\rho_{01}S_1v)^2 - 4(-\rho_{01})(\rho_{02}S_2 - \rho_{01}S_1)(c_{01}v + S_1v^2) \quad (5.1.18)$$

With equation (5.1.17) and (5.1.13), P_2 can be determined, and if the projectile and the body is of the same material equation (5.1.17) can then be rewritten to equation (5.1.19).

$$U_p = \frac{\rho_{01}(c_{01}v + S_1v^2)}{\rho_{02}c_{02} + \rho_{01}c_{01} + 2\rho_{01}S_1v} \quad (5.1.19)$$

Pressure and wave velocity is the same for the projectile and body. Also the same material is used, meaning that S_1 and S_2 from EOS has the same value:

$$\rho_{01} = \rho_{02} = \rho_0 \quad c_{01} = c_{02} = c \quad S_1 = S_2 = S \quad (5.1.20)$$

Now equation (5.1.20) becomes simpler:

$$U_p = \frac{1}{2}v \quad (5.1.21)$$

The last equation shows that for two bodies with the same material properties subjected to a plastic impact the particle velocity is equal to half of the impact velocity of symmetric impact, which means the particles in the projectile transfer half of their momentum to the body (Meyers, 1994).

The example also shows how conservation of momentum and EOS can be used in order to determine the pressure and particle velocity.

6 Finite Element-Modelling of Dynamic Problems

Propagating waves result in high loads during a short period of time which makes it difficult to analyse, especially for larger structures, therefore finite element software is developed. Challenges today about the FE-models are that it is still needed to control the model so the results are valid. With increasing complexity in the models this gets harder and harder. One other aspect is to make the models time efficient. Often the regular user, e.g. a structural engineer, does not have the time to wait for days in order to receive the results from a simulation.

6.1 Element types

When creating a FE-model it is important to choose suitable element types. There are three common elements types that can be used in the analysis; continuum elements in two or three dimensions, structural elements e.g. beam elements, shell elements and special elements e.g. springs, dampers and joints, see Figure 6.1.1. The element types have some differences and which one to use depends on what type of response and failure modes the model should describe. Structural elements resemble fabricated structural components and represent the geometry of the structure. Continuum elements do not resemble fabricated structural components at all. Special elements are derived from a continuum mechanics stand point but include features similarly related to the physics of the problem. For instance beam and shell elements can describe bending, but unfortunately not shear failure (Plos, 2008).

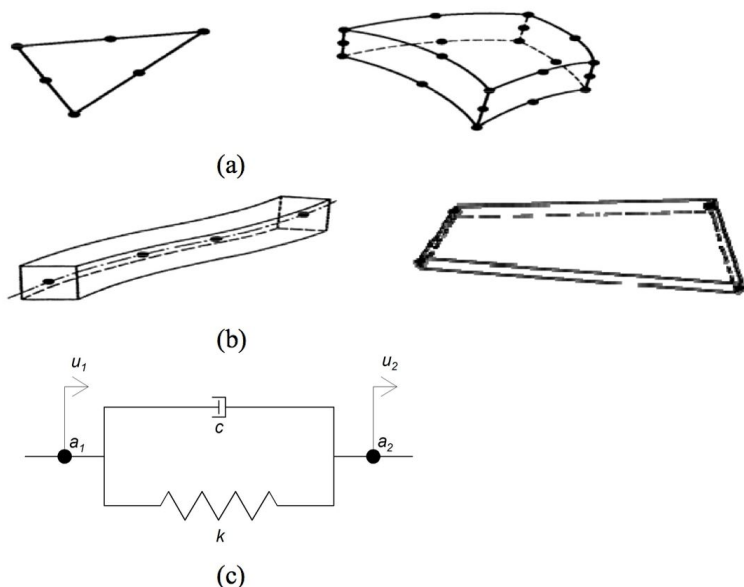

Figure 6.1.1: (a) Continuum elements, (b) Structural elements, (c) Special elements (Plos, 2008).

The shape of the elements can be divided into linear or quadratic. The simplest line elements consist of two nodes and one element and usually with a cross-section area. Quadratic are made with curved elements that have three or four nodes (Ellobody, 2014).

7 Case Studies

The case studies are performed in order to see if there is a realistic possibility to create a thin structure with the same response as a thicker structure. The design process of this structure begins with a decision of which response and properties the structure should have, instead of choosing the material and dimensions first.

The first tests are carried out to see how well the transformational elastodynamics theory works. Different material properties are used and tested combined with different transformation functions in order to see how this affects, the properties of the transformed structure. The aim is to see if there is an optimal way to choose the variation of the material properties and transformation function.

Furthermore, in order to cancel a wave it is possible to do so by adding several layers. This means that the stress wave which propagates through the material will reflect step by step. When the stress wave reaches the other side of the structure, the stress amplitude is smaller than it was from the beginning. In order to find the number of layers and material properties for each layer a MATLAB code has been developed. After the desirable behaviour is determined, a transformation can be done in order to find the material properties and the dimensions for the new structure.

The following case studies are confirmed with a numerical analysis in a FE-program, LS-DYNA and this in order to verify the results from the hand calculations. LS-prepost is combined with LS-DYNA to handle the modelling and analysing the results. It is important to mention that the following studies can be done in other FE-program with same results.

7.1 Case study 1 - Transformation of rod with constant material properties

The first study is done in order to verify the transformational elastodynamics theory. A 1 meter long rod is studied and the aim is to transform it to a 0.5 meter long rod with the same dynamic response, see Figure 7.1.1. The incident stress wave hits the rod on the free end while the second edge is considered as fixed. The density and the Young's modulus are constant over the whole length of the rod. Verification of the model is done with hand calculations and with the FE-software LS-DYNA. All the results from the calculations are presented in Section 8.1.

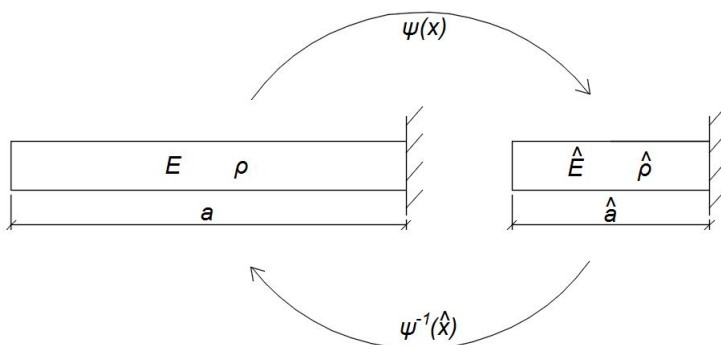

Figure 7.1.1: Transformation of a rod with homogeneous material properties.

In this study the transformation equation is chosen as a linear function and is defined in equation (7.1.1). In order to calculate $\beta(x)$ it is necessary to know the derivative and inverse of the transformation function which is defined in equation (7.1.2) and (7.1.3).

$$\psi(x) = \frac{\hat{a}}{a} \cdot x \quad (7.1.1)$$

$$\psi'(x) = \frac{\hat{a}}{a} \quad (7.1.2)$$

$$\psi(\hat{x})^{-1} = \frac{a}{\hat{a}} \cdot x \quad (7.1.3)$$

With the equations above it is possible to calculate $\beta(x)$ in order to find the new material properties for the smaller rod. $\beta(x)$ is calculated according to equation (7.1.4).

$$\beta(\hat{x}) = \psi'(\psi^{-1}(\hat{x})) = \frac{\hat{a}}{a} \quad (7.1.4)$$

Using equation (4.4.12) and (4.4.13) combined with (7.1.4) to transform Young's modulus and the density into the other coordinate system and thereby finding the material properties for the 0.5 meter long rod. The material properties are defined according to equation (7.1.5) and (7.1.6).

$$\hat{E}(\hat{x}) = \beta(\hat{x}) \cdot E(x) = 0.5 \cdot E_0 \quad (7.1.5)$$

$$\hat{\rho}(\hat{x}) = \frac{1}{\beta(\hat{x})} \cdot \rho(x) = 2 \cdot \rho_0 \quad (7.1.6)$$

$$\hat{c} = \sqrt{\frac{0.5 \cdot E_0}{2 \cdot \rho_0}} = \frac{1}{2} \sqrt{\frac{E_0}{\rho_0}} \quad (7.1.7)$$

With the material properties calculated from equation (7.1.5) and (7.1.6), the smaller rod should have the same dynamic response as the original rod. Equation (7.1.7) present the wave velocity for the transformed rod, as seen in the equation the velocity is half compared to the original rod. The material properties used in the calculations for both rods are presented in Table 7.1.1. The impedance of the two rods is the same, which is a requirement for the transformation to work, the relation can be seen in equation (7.1.8).

$$\rho \cdot c = \hat{\rho} \cdot \hat{c} \quad (7.1.8)$$

Table 7.1.1: Material indata for the rods.

Rod length [m]	Young's modulus [GPa]	Density [kg/m ³]	Applied force [N]	Sectional area [m ²]
$a = 1.0$	$E_0 = 210$	$\rho_0 = 7850$	$F = 500$	$A = 6.45 \cdot 10^{-4}$
$\hat{a} = 0.5$	$\hat{E} = 105$	$\hat{\rho} = 15700$	$F = 500$	$A = 6.45 \cdot 10^{-4}$

7.1.1 Calculations and modelling using LS-DYNA

In order to verify the hand calculations and get a view of what happens over time in the rod, a numerical analysis is done on all the case studies. This section will describe how the model is built, the other case studies follow the same modelling procedure and differences between the models will be presented in the following sections.

The FE-model is created to be able to verify the theory of transformational elastodynamics. Two rods are made in addition to compare different lengths and show that the two rods behaves in the same way, see Figure 7.1.2. No failure mode is of interest and therefore not considered in this model.



Figure 7.1.2: A comparison between the two rods, model created in LS-DYNA.

Size of model

The whole FE-model does not need to have a large size to be able to describe the theory of elastic impact. The model needs to have a length, so the wave can travel through a material and be illustrated with its discontinuity from the state before and after the wave front. Mesh size of the model will be described in Section 7.1.2.

Boundaries

The rod is fixed in the end node to the right side, no displacements in any direction of this node can occur. Furthermore, the other side of the rod is set as free and is attached with a nodal force in addition to create a satisfactory impulse event.

Material

A homogeneous material is suitable to describe the particle velocity and displacements in the model. The material model used in calculations only takes elastic behaviour in to account. The material properties which are specified in the software are density, Young's modulus and Poisson's ratio. The material properties used in this case are stated in Table 7.1.1.

Choice of element type

Structural elements such as beam element can show the particle velocities and displacements for the one-dimensional rod after impact and give a reasonable running time for the model. Hence, beam elements are used in the models.

Section

"Section" defines the cross-sectional properties for the beam elements. In "section" several selections of element formulation options (ELFORM) can be chosen. In this case study it is set to truss elements, meaning that this element formulation is applied to the element type. Furthermore, only one cross section is needed, see Table 7.1.1 for chosen cross-section area.

Loading

In order to establish the same behaviour as for an impact event that generates a dynamic impulse, a load is defined in LS-DYNA which acts in short period of time. In the FE-program nodal point load is a suitable function to use. The load acts in a specific time interval which is defined with a load curve. Load level is set to 500N acting constant on a time interval of 0-0.002 seconds. The wave created hits the fixed boundary at approximate $0.2 \cdot 10^{-3}$ s.

7.1.2 Convergence study of the FEM-model

To specify how many elements that the model should be created with a convergence study is made. Time is an important factor in the studies, the convergence check is done with velocity or displacement versus time. First different mesh sizes are compared in the same node. Figure 7.1.3 shows a convergence check of the of the particle velocity at a specific time that illustrates the difference between particle velocity for 5, 10, 20, 40 and 60 elements. This shows that a model with 20, 40 and 60 elements in each layer is sufficient to get accurate results.

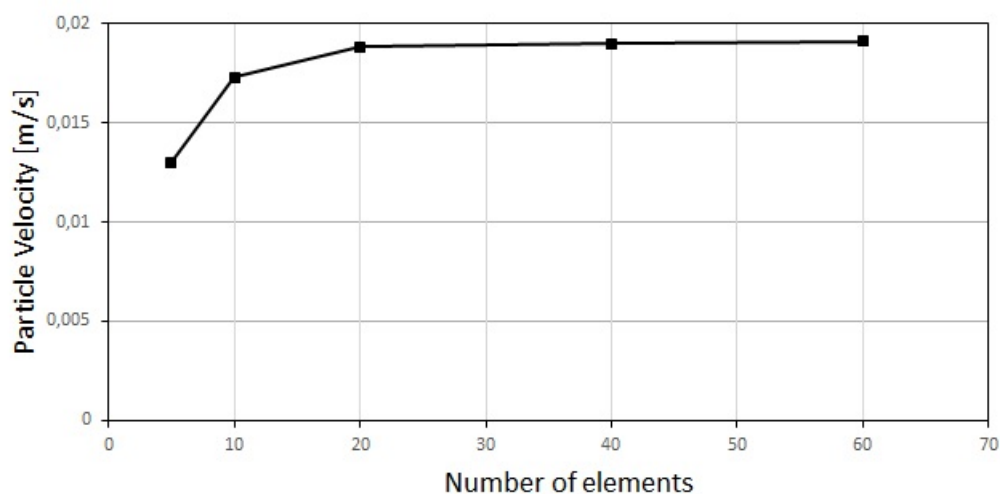

Figure 7.1.3: Diagram illustrating results in particle velocity for different mesh sizes.

In order to get a faster computer time, the three different element sizes was compared with a displacement versus time diagram. By doing this, it can be seen how the choice of element size effect both phase difference in time and the results for displacement. Figure 7.1.4 illustrates the convergence check of the displacement, two things can be noticed. First, the mesh sizes with 40 and 60 elements are almost equal; a small difference can be seen, but it is too small and therefore neglected in this study. Second, the model with a mesh size of 20 elements has both a phase difference and also different results of displacement or velocity compared to the other mentioned elements sizes. This shows that a model with 40 elements in each layer is sufficient to get accurate results and give a faster computing time of the model compare to models with 60 elements in each layer, therefore models in later studies contains 40 elements in each layer.

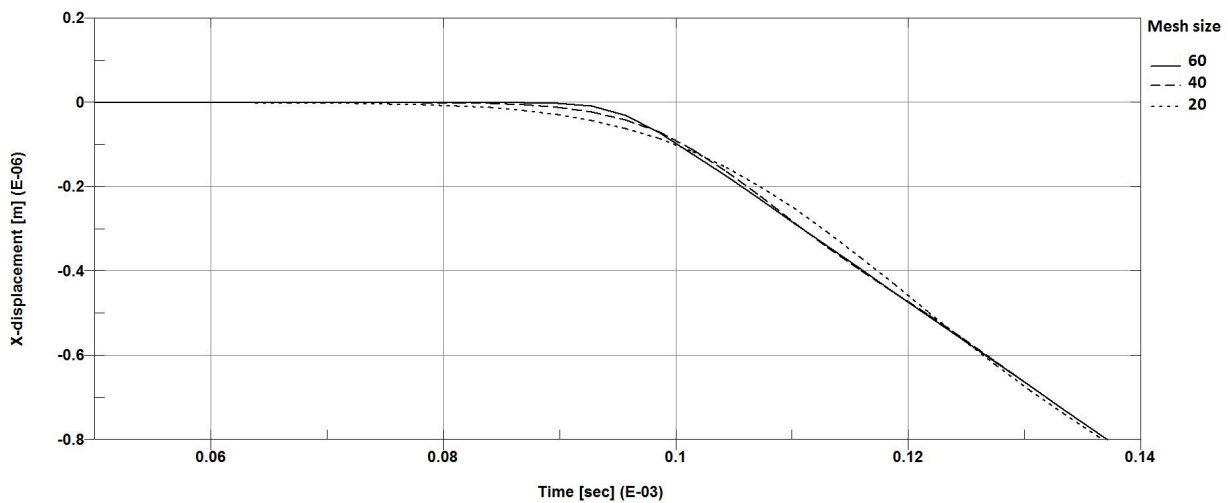

Figure 7.1.4: Diagram illustrating different mesh sizes, 60, 40 and 20 elements.

7.1.3 Damping

In Section 4.2.2 it was mentioned that damping could be neglected in the dynamic analysis because of the small influence on the results. To see how much influence it has on the model, it is possible in FE-analysis to consider damping and see the difference with and without damping. A specific material damping ratio has to be known in order for the program to calculate the damping for the model. Some error can occur in the FE-analysis with damping depending on which specific frequency range is of interest. See Section 8.1.3, for results from the analysis.

7.2 Case study 2 - Transformation of rod with varying material properties

As mentioned before one way to build a protective wall is to add several layers to the structure, the wave will then reflect step by step and depending on the material properties the reflections will be different between the layers. The transmitted stress which exit the structure can be lower than the incident stress.

As seen in Figure 7.2.1, the rod (from the last example) is now divided into ten layers with different material properties. The main purpose is that the reflections between the materials will lower the stress constantly through the material. The transformed rod still has a length of 0.5 meter.

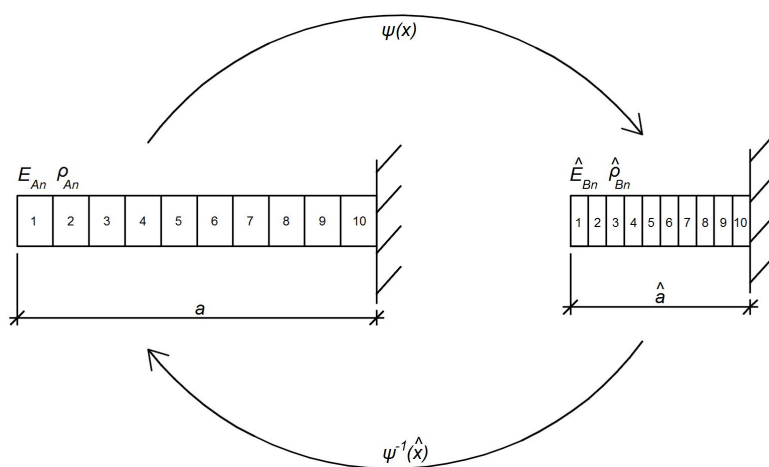

Figure 7.2.1: Linear transformation from 1 meter to a 0.5 meter long rod, with ten materials.

The material properties vary linearly and are approximated as illustrated in Figure 7.2.2, and the material indatna is defined in Table 7.1.1, where steel is the material in the first layer.

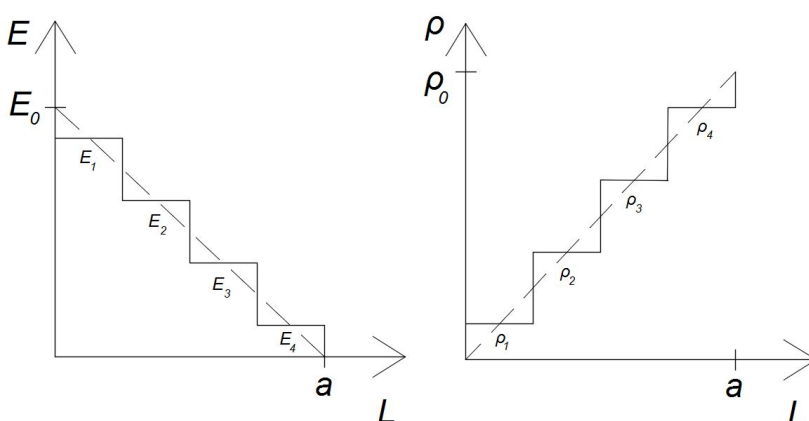

Figure 7.2.2: Example showing a variation of the elastic modulus and the density.

Equation (7.2.1) and (7.2.2) defines how Young's modulus and the density vary through the thicker rod. It is hard to find a material which vary exactly as described in Figure 7.2.2. Because of this, the material properties are taken in the middle point of each layer; which result in an approximation of the material curves.

$$E(x) = \left(1 - \frac{x}{a}\right)E_0 \quad (7.2.1)$$

$$\rho(x) = \rho_0 \frac{x}{a} \quad (7.2.2)$$

The same ψ -function is used in this study as in the last study, it is defined in equation (7.1.1). Using the same ψ -function, will result in the same $\beta(x)$ as in the previous case and is presented in equation (7.2.3).

$$\beta(\hat{x}) = \frac{\hat{a}}{a} \quad (7.2.3)$$

With the calculated $\beta(\hat{x})$ it is possible to find the new material properties for the 0.5 meter long rod by using the same equations as in case one. The material properties now vary along the length of the rod and are extracted in the same manner as for the longer rod. The expression for Young's modulus and the density are stated in equation (7.2.4) and (7.2.5) where $a = 1$ m and $\hat{a} = 0.5$ m is included in the equations.

$$\hat{E}(\hat{x}) = E_0 \cdot \left(\frac{1}{2} - \hat{x}\right) \quad (7.2.4)$$

$$\hat{\rho}(\hat{x}) = 4\rho_0 \cdot \hat{x} \quad (7.2.5)$$

$$\hat{c} = \frac{1}{2} \cdot c \quad (7.2.6)$$

Using the new material properties for the 0.5 meter long rod, should result in the same dynamic response as for the longer rod. The wave velocity is half for the transformed rod compared to the original rod, see equation (7.2.6). The impedance need to be the same between in each layer in order for the transformation to work. All the results from this case study can be seen in Section 8.2.

7.2.1 Calculations and modelling using LS-DYNA

This FE-model is created to be able to verify the theory of transformational elastodynamics with several layers. The rod has the same boundaries and load as for the first case study, the new material properties are inserted. Two rods are made in addition to compare different lengths of them and show that the transformation is valid, same results for the two rods are expected. No failure mode is of interest and therefore not considered in this model.

Size of model

The size of the model is different from the first case study, since it is made with several layers to get the response from the reflected waves. It is important that the nodes between the layers have been merged together, otherwise the wave will not be able to travel and be transmitted into the next layer. Mesh convergence has been done and shows same the results as for the first case study, where 40 elements in each layer are sufficient.

7.3 Case study 3 - Transformation of rod with varying material properties and a non-linear ψ -function

Up to this point the ψ -function has been a linear function. The function has a great influence on how the material properties will vary through the transformed rod. As mentioned before ψ -function can be chosen almost freely and need to fulfil the following two conditions, $\psi(a) = \hat{a}$ and $\psi(\hat{a}) = a$. It also needs to be invertible and sufficiently differentiable together with its inverse. In this case study the new ψ -function used in calculations are defined in equation (7.3.1). The lengths of the rods are the same as before.

$$\psi(x) = \frac{\hat{a}}{a} \cdot x^2 \quad (7.3.1)$$

By choosing a transformation function $\psi(x)$ which is not linear the calculations become more complex. The material properties will vary in a non-linear way. Furthermore, the reflections do not take place in the same position anymore because of the non-linearity. The reflections need to take place at the same time, which implies that the layer thickness will be different than from the linear case. In order to find the thickness of each element for the smaller rod, the x -coordinate where the reflection occur in the original rod is transformed into a new coordinate in the system where the reflection occur for the smaller rod, see Figure 7.3.1. The layer thickness will therefore not be constant as in previous studies. The material properties are taken from the middle of each layer exactly as before.

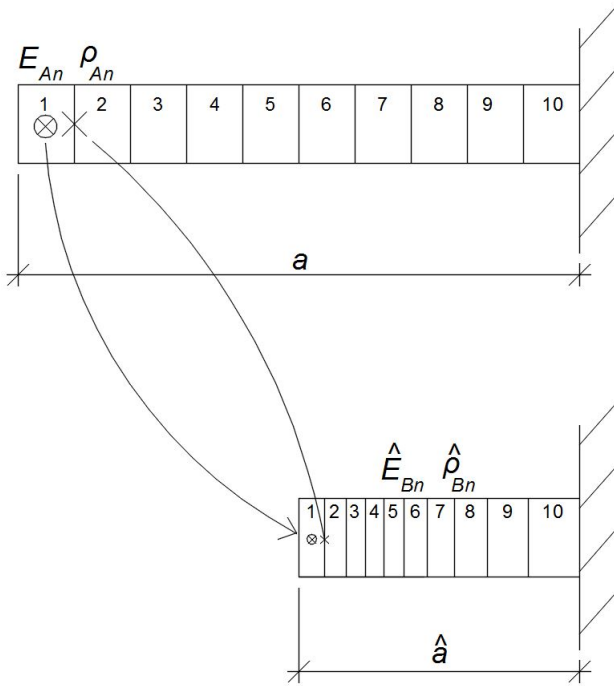

Figure 7.3.1: Transformation of the rod when using a non-linear ψ function.

The inverse and the derivative of equation (7.3.1), with the numerical values of a and \hat{a} , is defined in equation (7.3.2) and (7.3.3).

$$\psi'(x) = 2 \cdot \frac{0.5}{1} \cdot x = x \quad (7.3.2)$$

$$\psi^{-1}(\hat{x}) = 1.414\sqrt{\hat{x}} \quad (7.3.3)$$

Since it is impossible to have a material with zero density or Young's modulus equal to zero their functions have been modified in order to avoid that case. Young's modulus and the density is constantly decreasing, in order for the transmitted stress to constantly decrease through the rod. The new equations for the material properties are stated in equation (7.3.4) and (7.3.5).

$$E(x) = E_0 \left(\frac{1}{10}x + (1-x) \right) \quad (7.3.4)$$

$$\rho(x) = \rho_0 \left(\frac{1}{10}x + (1-x) \right) \quad (7.3.5)$$

With these parameters known it is possible to calculate $\beta(\hat{x})$, which is calculated in the same manner as in the previous cases. The difference now is that $\beta(\hat{x})$ will no longer be a constant as before.

$$\beta(\hat{x}) = 1.414\sqrt{\hat{x}} \quad (7.3.6)$$

The new material properties for the small rod are calculated using equation (7.3.7) and (7.3.8).

$$\hat{E}(\hat{x}) = 1.414\sqrt{\hat{x}} \cdot E_0 \left(\frac{1}{10} 1.414\sqrt{\hat{x}} + (1 - 1.414\sqrt{\hat{x}}) \right) \quad (7.3.7)$$

$$\hat{\rho}(\hat{x}) = \frac{\rho_0 \left(0.1 \cdot 1.414\sqrt{\hat{x}} + (1 - 1.414\sqrt{\hat{x}}) \right)}{1.414\sqrt{\hat{x}}} \quad (7.3.8)$$

By using the two equations above it is possible to find the new material properties which are suited for the smaller rod in order to have the same dynamic response as for the longer rod. The impedance still need to be equal between the two rods in each layer even if the material properties vary non-linear. Furthermore, the wave velocity for the transformed rod will no longer be half the velocity compared to the original rod. This is also the reason for the varying layer thickness for the transformed rod. To find the new points where the reflection shall occur the transformation function is used. All the results from this case study can be found in Section 8.3.

7.3.1 LS-DYNA calculations

FE-model is made in order to verify the results from the hand calculations. The model is built as in the previous case studies with same element size, boundaries and loading, but with different material properties. The new materials are inserted in the FE-model and then used to verify the results from the hand calculations, see Section 8.3.2. The small rod and the long rod are made in the same model, which makes the comparison easier. No failure modes are of interest.

7.3.2 Size of model

The model has same amount of layers, but as mentioned before the ψ -function will effect the length of each layer and therefore the layers will not have the same lengths as case study two. As for case study two it is important that nodes between each layers are merged together. A mesh convergence check has been done in order to find the right amount of elements, as for the other case studies 40 elements in each layer are sufficient.

7.4 Case study 4 - Transformation of rod with varying material properties and ψ -function

Up to this point only two ψ -functions have been tried, as seen from case number three it has a major part in the transformation and the new material properties. Therefore, a third function is tried in order to see if there is an optimal way to transform the material properties. Optimal means that the transformed values correspond well to real materials.

To find the new ψ -function a Mathematica document was created, see Appendix D for the derivation. It is possible to control the initial conditions and the derivative of the function. By this it is possible to exclude the functions that give values which go to infinity or zero and therefore generate unreasonable

material properties. The length of the rods (a and \hat{a}) are the same as in the previous cases so it is possible to do a comparison between the different studies.

Equation (7.4.1) states the ψ -function used in the calculations for this case. It is a third degree polynomial and the lengths a and \hat{a} are already included in the equation.

$$\psi(x) = x \left(1 + \frac{x(-2a+x)}{2a^2} \right) \quad (7.4.1)$$

The equations describing the material properties are the same as for case three and are defined in equation (7.4.2) and (7.4.3).

$$E(x) = E_0 \left(\frac{1}{10}x + (1-x) \right) \quad (7.4.2)$$

$$\rho(x) = \rho_0 \left(\frac{1}{10}x + (1-x) \right) \quad (7.4.3)$$

$\beta(\hat{x})$ and the new material properties Young's modulus $\hat{E}(\hat{x})$, and the density $\hat{\rho}(\hat{x})$, are calculated in the same way as before. In this case study it is not done by hand, instead Mathematica has been used to calculate the new material properties. Mathematica is used because the derivation is hard to do by hand. The functions can be seen in Appendix D.

When all the material properties are calculated the dynamic response of the smaller rod can be calculated. As in case study three the layer thickness needs to be recalculated since the reflections need to be at the same time for both of the rods. As in previous cases the impedance needs to be the same for both the rods and each layer needs to have the same impedance. The results from the calculations can be viewed in Section 8.4.

7.4.1 LS-DYNA calculations

FE-model is made in order to verify the results from the hand calculations. As for case study three, the length for each layer will be different and not constant. This case study uses another ψ -function, in which a transformation of the length with its function will be made. The two rods are made in the same model in order to make the comparison easier. The rod has the boundaries and load but different material properties. No failure modes are of interest.

7.4.2 Size of model

The model has same amount of layers, but as mentioned before the ψ -function will effect the length of each layer and therefore the layers will not have the same lengths as case study two and three. All nodes between each layer should be merged together. As for the other cases studies, a mesh convergence check has been done in order to find the right amount of elements, where 40 elements in each layer are sufficient.

7.5 Case study 5 - Design of rod with real materials

All the cases studied in this project this far have been with theoretically calculated material properties. In this study the aim is to design a rod which decrease the stress amplitude of the incident wave and find real materials which can satisfy the transformation.

As mentioned before when a wave goes from one medium to another the wave is divided into two parts, one reflected wave and one transmitted wave, see Section 4.3. This means that every time a reflection takes place the stresses rearrange in the material. If the rod has several layers with the right material properties the transmitted stress wave amplitude will get lower for each reflection. The transmitted and reflected stress amplitudes are defined in equation (7.5.1) and (7.5.2), where A and B represent the different materials.

$$\sigma_T = \frac{2\rho_B c_B}{\rho_A c_A + \rho_B c_B} \cdot \sigma_I \quad \text{Transmitted stress} \quad (7.5.1)$$

$$\sigma_R = \frac{\rho_B c_B - \rho_A c_A}{\rho_B c_B + \rho_A c_A} \cdot \sigma_I \quad \text{Reflected stress} \quad (7.5.2)$$

By inserting the expression for the wave velocity $c_n = \sqrt{E_n/\rho_n}$, in equation (7.5.1) and (7.5.2). Equation (7.5.3) and (7.5.4) can then be derived.

$$\sigma_T = \frac{2\sqrt{\rho_B E_B}}{\sqrt{\rho_B E_B} + \sqrt{\rho_A E_A}} \cdot \sigma_I \quad (7.5.3)$$

$$\sigma_R = \frac{\sqrt{\rho_B E_B} - \sqrt{\rho_A E_A}}{\sqrt{\rho_B E_B} + \sqrt{\rho_A E_A}} \cdot \sigma_I \quad (7.5.4)$$

By looking at equation (7.5.3) and (7.5.4) it can be seen that lowering the product between Young's modulus and the density result in a lower transmitted stress. This can be used in design to lower the stress amplitude constantly through the rod.

Finding the number of reflections needed in order to lower the final transmitted stress is an iterative process. In the iterative process the product $E \cdot \rho$ is lowered step by step by a constant. However, how the product decreases has a large influence on the number of reflections and transmitted stress. Figure 7.5.1 presents how the product decreases in each layer when multiplied with a factor 0.5.

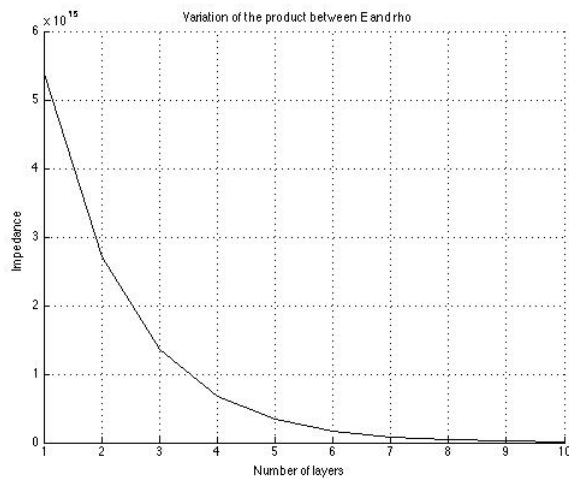

Figure 7.5.1: Decreasing product between Young's modulus and the density multiplied by a factor 0.5 for every reflection.

The calculation gives a reflected and a transmitted stress for each layer combined with the product of Young's modulus and the density. The iteration can be controlled by limiting the number of reflections or the transmitted stress. The length in this stage is arbitrary which means that the length does not matter in the calculations. The only interesting part is to find a suitable behaviour of the rod. The length is however set to 1 meter, since it is then possible to compare it to the other cases that are studied. When the behaviour is set it is possible to use the theory presented in Section 4.4 in order to find new material properties, which will make the short rod behave in the exact same manner as the original rod.

To use the theory of transformational elastodynamics the material parameters need to be defined as functions of the length of the rod. This is done by approximating a curve to the calculated values. With these functions known it is possible to find new material parameters for the small rod. This is done with two different ψ -functions, see equation (7.5.5) and (7.5.6). The reason for choosing two functions is to see if there is any difference in the dynamic response and any difference between the material properties between the two functions. The ψ -function from case study three is excluded in this study because of the unreasonable material properties.

$$\psi(x) = x \left(1 + \frac{x(-2a + x)}{2a^2} \right) \quad (7.5.5)$$

$$\psi(x) = \frac{\hat{a}}{a} \cdot x \quad (7.5.6)$$

$\beta(\hat{x})$ is derived in the same manner as before for both functions and with $\beta(\hat{x})$ known it is possible to find the material properties for the small rod.

Up to this point all of the materials are theoretical. The challenge is to find material properties which suit the theoretical values. The product between Young's modulus and the density is calculated for the theoretical values and the real materials. The materials with matching or close to the theoretical values are chosen, this is done for both ψ -functions.

Once the material properties are set, a new calculation is done in order to find the real dynamic response of the rods with the real materials.

7.5.1 LS-DYNA

Calculated materials and lengths will be inserted into LS-DYNA to verify the difference between the models with real materials. All functions will be tried out. The rod has the same element size, boundaries and loading as for previous case studies. No failure modes are of interest.

7.5.2 Size of model

The model has the same amount of layers, but as mentioned before the ψ -function will affect the length of each layer and therefore the layers will not have the same lengths as case study two and three. As for the other cases studies, a mesh convergence check has been done in order to find the right amount of elements, where 40 elements in each layer are sufficient.

8 Results from the Case Studies

There are several different case studies done in the project. The first studies were simple examples in order to understand and verify the theory presented in the literature survey. In the last case study the theories are combined in order to create a rod with real materials. Each case study is verified with hand calculations and numerical analysis done in the FEM program, LS-DYNA.

8.1 Results Case Study 1

This case study is made in order to show the theory of transformation elastodynamics. The ψ -function vary linearly and is derived in Section 7.1, the study is made with only one layer in each rod. Therefore, the material properties are constant over the whole length for the original and transformed rod.

8.1.1 Hand calculations

The calculations are performed according to equations from Section 4.3.1, where the transmitted, reflected and incident stresses are derived. The particle velocity and the stresses are calculated according to the same Section. The calculations are presented in Appendix A. Material properties are defined in Table 7.1.1.

The results from the hand calculations are presented in Table 8.1.1. These results are to be compared with the calculations from LS-DYNA in order to verify the method, see Section 8.1.2.

Table 8.1.1: Results from hand calculations for a rod with homogeneous material.

Rod length [m]	Particle velocity, U_p [m/s]	Initial stress, σ_I [MPa]	Wave velocity [m/s]
$a=1$	0.019	0.775	5172
$\hat{a}=0.5$	0.019	0.775	2556

The calculation shows that the two rods have the exact same dynamic response since the particle velocity and the initial stresses are equal. The results are expected since the wave needs to hit the boundaries at the same time in order to have the same response. In this case the transformed rod is half the length of the original rod and the velocity is half for the transformed rod. This means that the wave hit the fixed boundary at the same time.

Figure 8.1.1 shows how the wave velocity varies for the two rods. As can be seen it is constant throughout the length, which is expected since the transformation is linear.

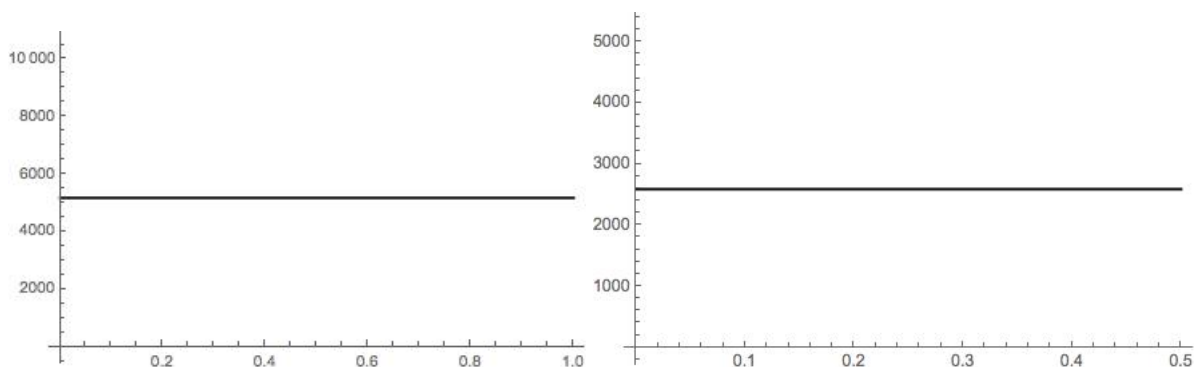

Figure 8.1.1: Wave velocity for the 1 meter long rod (left) and for the 0.5 meter long rod (right).

8.1.2 LS-DYNA calculations

The model is done according to the method presented in Section 7.1.1. The applied force and material properties are the same as for the hand calculations.

Figure 8.1.2 shows the displacement change during time t . As seen in the figure the displacement change direction after $\sim 0.37 \cdot 10^{-3}$ s when it hits the free end and the wave change from a compression wave to tension wave. The results are extracted from node one, which is the first node to the left in the model, it is the same node as the applied force.

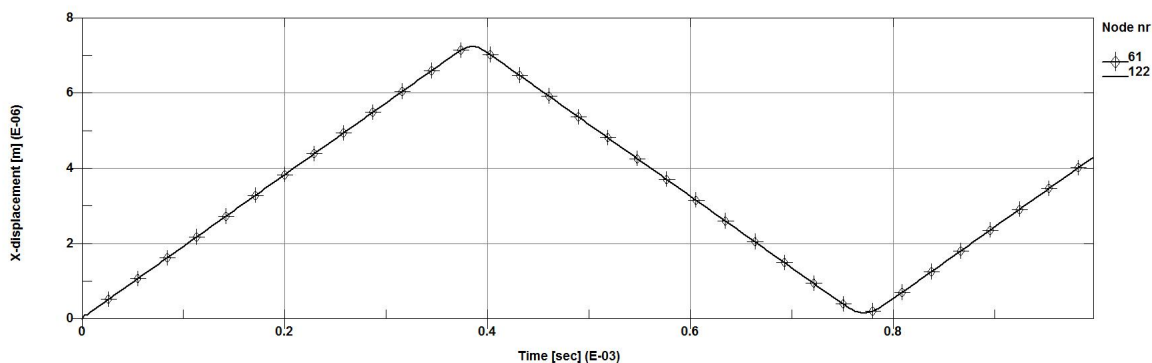

Figure 8.1.2: Displacement for transformation of 1 meter long rod (point line) to a 0.5 meter long rod (regular line).

8.1.3 Rod with Damping

To be able to see the differences between a rod with and without damping two models have been compared in the FE-program, LS-DYNA. The damping ratio is set to $\xi = 0.01$. The material parameters and model indata is presented in Table 7.1.1. Results from LS-DYNA are presented in Figure 8.1.3 and 8.1.4.

Table 8.1.2: Particle velocity without and with damping.

Particle velocity without damping, U_P [m/s]	Particle velocity with damping, U_P [m/s]
0.019	0.0185

It can be seen that the curve with damping take more time to reach its peak value, compared to the curve without damping. In Table 8.1.2 it can be seen that the particle velocity had decreased, but not enough make a difference. Due to the small influence of the damping it is neglected in further calculations.

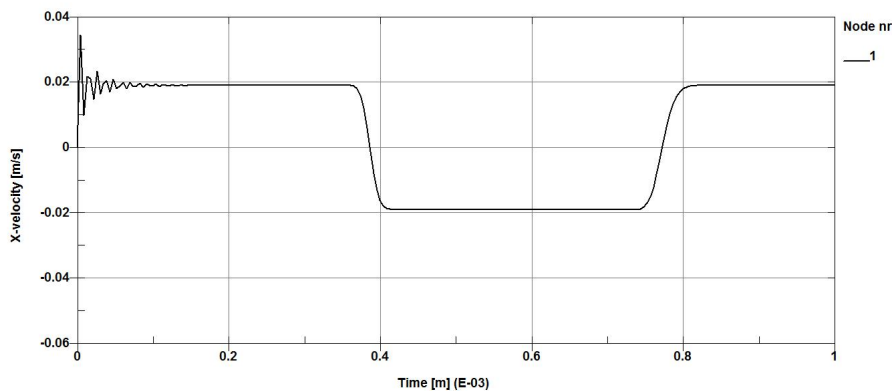

Figure 8.1.3: Particle velocity for the 1 long meter steel rod in one node.

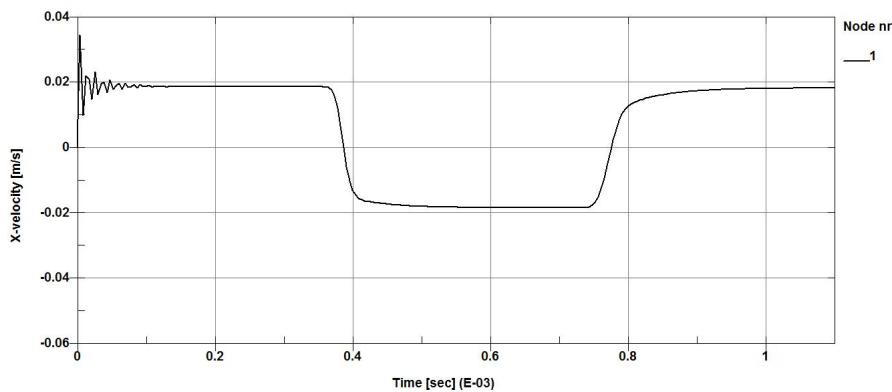

Figure 8.1.4: Particle velocity for the 1 meter long steel rod with damping in one node.

8.2 Results Case Study 2

The two rods from case study one are now divided into ten different layers in order to be able to vary the material properties through the lengths of the rods. This will also create reflections at each interface of the materials, which can lower the stress amplitude in the rods. The ψ -function used in this case study is the same as used in the previous study.

8.2.1 Hand calculations

The material properties vary according to equation (7.2.1) and (7.2.2) presented in Section 7.2. Figure 8.2.1 presents how the density and Young's modulus varies over the length for the original rod and for the transformed rod. The variation of the transformed material properties are still linear. This is because the transformation only depends on a constant, $\beta(\hat{x}) = 0.5$. The material data is extracted in the middle of each layer in the rods, where the layer thickness is 0.05 meter for the transformed rod and 0.1 meter for the original rod.

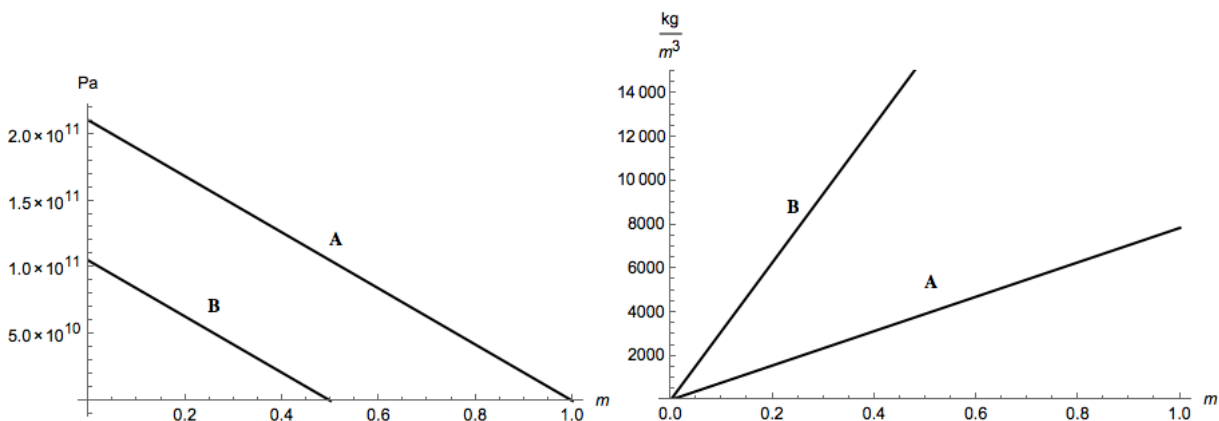

Figure 8.2.1: The variation of Young's modulus (left figure) and the density (right figure) before curve A, and after transformation curve B.

The wave velocities for both rods can be seen in Figure 8.2.2. As seen in the figures and the tables below the wave velocity is half the value compared to the original rod. This is due to the linear ψ -function.

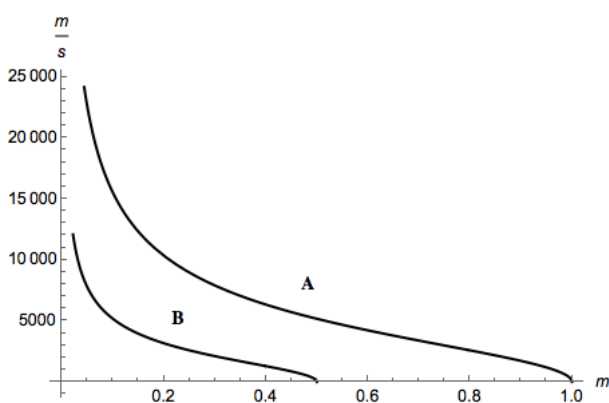

Figure 8.2.2: The wave velocity for the original rod (curve A) and for the transformed rod (curve B).

The material properties for the 1 meter long rod are presented in Table 8.2.1 and 8.2.2 for the 0.5 meter long rod, which are used as indata for when calculating the dynamic response of the two rods. The calculations of the material properties are presented in Appendix B.

Table 8.2.1: Material indata for a 1 meter long rod with ten different layers.

Layer	Thickness of layer	Young's modulus [GPa]	Density [kg/m ³]	Wave velocity [m/s]
1	0.1	199.5	392.5	22 5545.1
2	0.1	178.5	1177.5	12 312.3
3	0.1	157.5	1962.5	8958.5
4	0.1	136.5	2747.5	7048.5
5	0.1	115.5	3532.5	5718.1
6	0.1	94.5	4317.5	4678.4
7	0.1	73.5	5102.5	3795.4
8	0.1	52.5	5887.5	2986.2
9	0.1	31.5	6672.5	2172.8
10	0.1	10.5	7457.5	1186.6

Table 8.2.2: Material indata for a 0.5 meter long rod with ten different layers.

Layer	Thickness of layer	Young's modulus [GPa]	Density [kg/m ³]	Wave velocity [m/s]
1	0.05	99.75	785.0	11 272.50
2	0.05	89.25	2355.0	6156.10
3	0.05	78.75	3925.0	4479.30
4	0.05	68.25	5495.0	3524.30
5	0.05	57.75	7065.0	2859.00
6	0.05	47.25	8635.0	2339.20
7	0.05	36.75	10 205.0	1897.70
8	0.05	26.25	11 775.0	1493.10
9	0.05	15.75	13 345.0	1086.40
10	0.05	5.25	14 915.0	593.2910

As mentioned before and seen in Figure 8.4.1 the material properties varies as expected, both Young's modulus and wave velocity for the longer rod becomes half for the smaller rod and the density is multiplied by two. The wave velocities are also expected since the stress waves need to hit each boundary at the same time for both the rods. The small rod is transformed with a linear function, which means that the wave velocity should be half compared to the original wave velocity. This in order to have the same dynamic response as the original rod, see Figure 8.1.1.

The results from the hand calculations for stresses are presented in Table 8.2.3 and the particle velocity in Table 8.2.4. A comparison between particle velocity and transmitted stress between the two rods shows that the rods have the same dynamic response. Therefore, the results for both of the rods are presented in the same tables, see Appendix B for hand calculations for the rods.

Table 8.2.3: Stresses in 1 meter long rod and 0.5 long rod with ten different material properties.

Layer	Incident stress, σ_I [MPa]	Reflected stress, σ_R [MPa]	Transmitted stress, σ_T [MPa]
1	0.775	0.188	0.963
2	0.963	0.093	1.055
3	1.055	0.051	1.106
4	1.106	0.023	1.129
5	1.129	0	1.129
6	1.129	-0.024	1.106
7	1.105	-0.053	1.052
8	1.052	-0.101	0.951
9	0.951	-0.230	0.721
10	0.721	0.721	1.442

Table 8.2.4: Particle velocity in 1 meter long rod and 0.5 long rod with ten different material properties.

Layer	Incident particle velocity, U_{pI} [m/s]	Reflected particle velocity, U_{pR} [m/s]	Transmitted particle velocity, U_{pT} [m/s]
1	0.088	-0.022	0.066
2	0.066	-0.006	0.060
3	0.060	-0.003	0.057
4	0.057	-0.001	0.056
5	0.056	0	0.056
6	0.056	0.001	0.057
7	0.057	0.003	0.06
8	0.06	0.006	0.066
9	0.066	0.016	0.081
10	0.081	-0.081	0

As seen in the tables the stress does not decrease between all the interfaces which depends on the material properties, where the product between Young's modulus and the density does not decrease between each layer. However, the dynamic response is the same between the two rods, which proves that the theory works and that it is possible to transform the rod with this method.

8.2.2 LS-DYNA calculations

The model is done using the method presented in Section 7.2.1. The model is created in order to verify the hand calculations.

Table 8.2.5 presents the particle velocity for each layer. It can be compared and verified with the hand calculations. It can be seen that the displacement and particle velocity is equal to each other. The dynamic response of the transformed and original rod is equal and therefore presented in the same table.

Table 8.2.5: Particle velocity for a 1 meter long rod and a 0.5 long rod, calculated with a linear transformation function in LS-DYNA.

Layer	Incident particle velocity U_{pI} [m/s]	Reflected particle velocity U_{pR} [m/s]	Transmitted particle velocity U_{pT} [m/s]
1	0.087	-0.021	0.066
2	0.066	-0.006	0.060
3	0.060	-0.003	0.057
4	0.057	-0.001	0.056
5	0.056	0	0.056
6	0.056	0.001	0.057
7	0.057	0.002	0.059
8	0.059	0.008	0.067
9	0.067	0.015	0.082
10	0.082	-0.082	0

Figure 8.2.3 shows the displacement for both rods over time t . The nodes where the results are extracted are where the load is applied to the left (the free end) of the rod. The displacements are equal to each other, which mean that the transformation works.

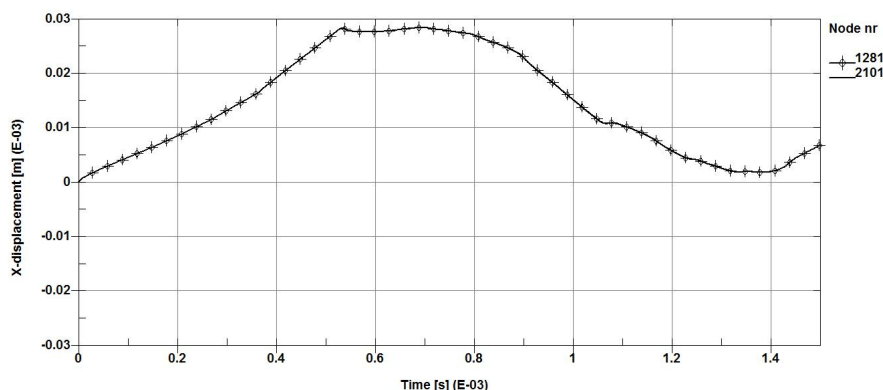

Figure 8.2.3: Displacements for 1 meter long rod with ten layers (point line) and for 0.5 meter long rod with four layers (regular line).

The results from the numerical analysis and the hand calculations are similar which is a proof that this method works for a rod with many layers. Although, the stresses have a small difference and therefore another case is analysed where the material properties decrease in another way.

8.3 Results Case Study 3

To see if there is a better way to choose the material parameters, another ψ -function is tried out. The rods used in this case are the same as for case two; the same applied force and cross-sectional area. Another function for the materials is tried in order for the stress wave amplitude to decrease through the length of the rods.

8.3.1 Hand calculations

Since the ψ -function can be arbitrary as long as it fulfils the boundary conditions, there can be a better ψ -function for the transformation which results in more reasonable material parameters. The chosen ψ -function for this case is shown in Section 7.3, equation (7.3.1).

The material properties for the long rod have been chosen to decrease. This is because the impedance constantly decreases through the rods, thereby the stress wave amplitude will be reduced when it travels through each layer. The new material equations are presented in Section 7.3, equation (7.3.4) and (7.3.5). Figure 8.3.1 presents how the material properties vary for the transformed (curve B) and original rod (curve A). As seen in the figure the material properties vary linearly for the 1 meter long rod, but for the transformed rod it vary non-linearly and it is because of the ψ -function which is no longer linear. The density for the transformed rod goes to infinity, see Figure 8.3.1, it is therefore not possible to see the value of the density for layer one.

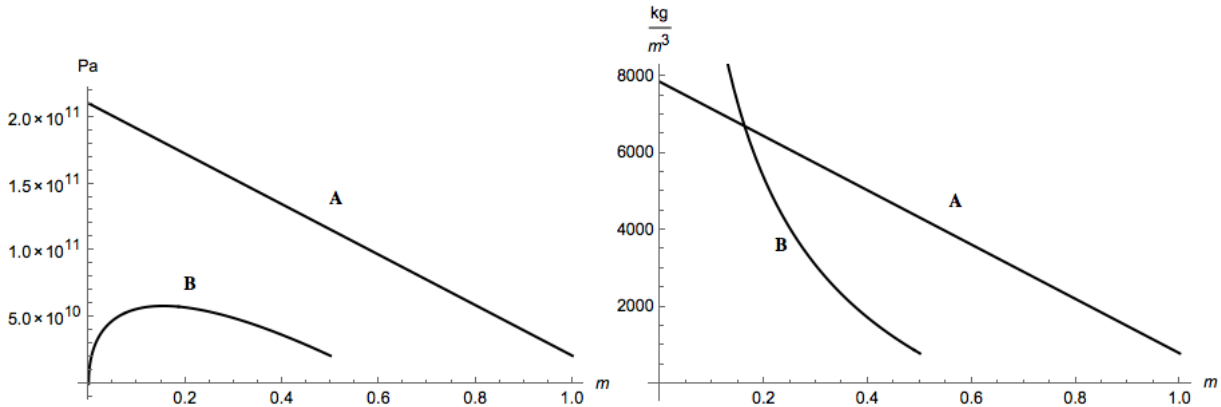

Figure 8.3.1: The variation of Young's modulus and the density before and after transformation.

The wave velocities for the two rods are presented in Figure 8.3.2. The wave velocity for the original rod (curve A in the figure) is constant. This depends on the defined material curves used in this case, where Young's modulus and the density decrease constantly. The wave velocity for the transformed rod behave in this manner due to the chosen ψ -function. Since the wave velocity is not halved for the transformed rod in each layer, the layer thickness need to be changed in order to get the same dynamic response in the both rods.

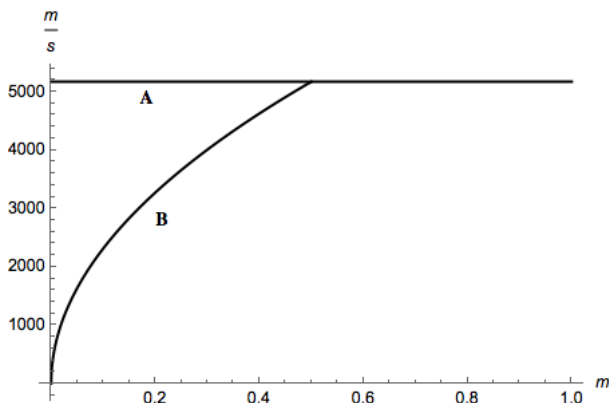

Figure 8.3.2: The wave velocity for the original rod (curve A) and for the transformed rod (curve B).

Two tables can be seen below, which present the material indata. Table 8.3.1 shows the indata for the 1 meter long rod and Table 8.3.2 for the 0.5 meter long rod. The material properties are calculated as before, they are extracted from the middle in each layer. The calculations for the material properties can be seen in Appendix C .

Table 8.3.1: Indata for a rod with ten layers 1 meter long rod.

Layer	Thickness of layer [m]	Young's modulus [GPa]	Density [kg/m ³]	Wave velocity [m/s]
1	0.1	200.55	7496.8	5172
2	0.1	181.65	6790.3	5172
3	0.1	162.75	6083.8	5172
4	0.1	143.85	5377.3	5172
5	0.1	124.95	4670.8	5172
6	0.1	106.05	3964.3	5172
7	0.1	87.15	3257.8	5172
8	0.1	68.25	2551.3	5172
9	0.1	49.35	1844.7	5172
10	0.1	30.45	1138.2	5172

Table 8.3.2: Indata for a rod with ten layers 0.5 meter long rod.

Layer	Thickness of layer [m]	Young's modulus [GPa]	Density [kg/m ³]	Wave velocity [m/s]
1	0.005	10.02	149 935.00	258.6
2	0.015	27.24	45 268.30	775.8
3	0.025	40.68	24 335.00	1293
4	0.35	50.34	15 363.60	1810
5	0.45	56.22	10 379.40	2327
6	0.055	58.32	7207.73	2845
7	0.065	56.64	5011.92	3362
8	0.075	51.18	3401.67	3879
9	0.085	41.94	2170,29	4396
10	0.095	28.92	1198.16	4914

As seen in Table 8.3.2 the transformed rod has unreasonable properties. This is due to the transformation which generates values that goes to infinity for the density and to zero for Young's modulus. It can also be seen in the table that the wave velocity differs from the original rod. This is due to the transformation no longer being linear. This means that the layers need to be of different size for the transformed rod so that the waves reflect at the same time for both the rods. Calculations of the dynamic response are calculated with the material properties presented in the tables above. The results from the calculations can be viewed in Table 8.3.3 and 8.3.4. The dynamic response of the two rods is exactly the same and the results for both the rods is presented in the same tables.

Table 8.3.3: Stresses for the 1 meter long rod and 0.5 meter long rod in each layer.

Layer	Incident stress, σ_I [MPa]	Reflected stress, σ_R [MPa]	Transmitted stress, σ_T [MPa]
1	0.775	-0.038	0.737
2	0.737	-0.040	0.697
3	0.697	-0.043	0.654
4	0.654	-0.046	0.608
5	0.608	-0.050	0.558
6	0.558	-0.055	0.503
7	0.503	-0.061	0.442
8	0.442	-0.071	0.371
9	0.371	-0.088	0.283
10	0.283	0.283	0.566

Table 8.3.4: Particle velocity for the 1 meter long rod and 0.5 meter long rod in each layer.

Layer	Incident particle velocity, U_{pI} [m/s]	Reflected particle velocity, U_{pR} [m/s]	Transmitted particle velocity, U_{pT} [m/s]
1	0.02	0.001	0.021
2	0.021	0.001	0.022
3	0.022	0.001	0.023
4	0.023	0.002	0.025
5	0.025	0.002	0.027
6	0.027	0.003	0.030
7	0.030	0.004	0.034
8	0.034	0.005	0.039
9	0.039	0.009	0.048
10	0.048	-0.048	0

Even if the material properties are unreasonable both the rods will still have the same dynamic response, see Table 8.3.3 and 8.3.4. This indicates that the theory works for all the ψ -functions, but the challenge is to find a function which deliver good material properties which correspond to existing materials. It can also be seen in the tables that the stress decreases between each layer, which is a desirable behaviour. When the stress wave strikes the last boundary there is no transmitted stress, this is due that the boundary is modelled as fixed which means that the stress wave will reflect and go back to the rod.

8.3.2 LS-DYNA calculations

The material properties are calculated by hand, see Table 8.3.1 and 8.3.2, then implemented in LS-DYNA. Both rods are defined in the same model and modelled in the same manner as the previous studies. The results are presented in Figure 8.3.3 and Table 8.3.5.

Table 8.3.5: Particle velocity for the 1 meter long rod and 0.5 meter long rod calculated with a non-linear transformation function in LS-DYNA.

Layer	Incident particle velocity, U_{pI} [m/s]	Reflected particle velocity, U_{pR} [m/s]	Transmitted particle velocity, U_{pT} [m/s]
1	0.020	0.001	0.021
2	0.021	0.001	0.022
3	0.022	0.002	0.024
4	0.024	0.001	0.025
5	0.025	0.002	0.027
6	0.027	0.002	0.029
7	0.029	0.004	0.033
8	0.033	0.006	0.039
9	0.039	0.009	0.048
10	0.048	-0.048	0

As seen in table 8.3.5 the particle velocity and the stresses are similar compared to the results from the hand calculations even if the material properties are unreasonable. This shows that the theory works well and the challenge is to find a ψ -function which produce reasonable properties.

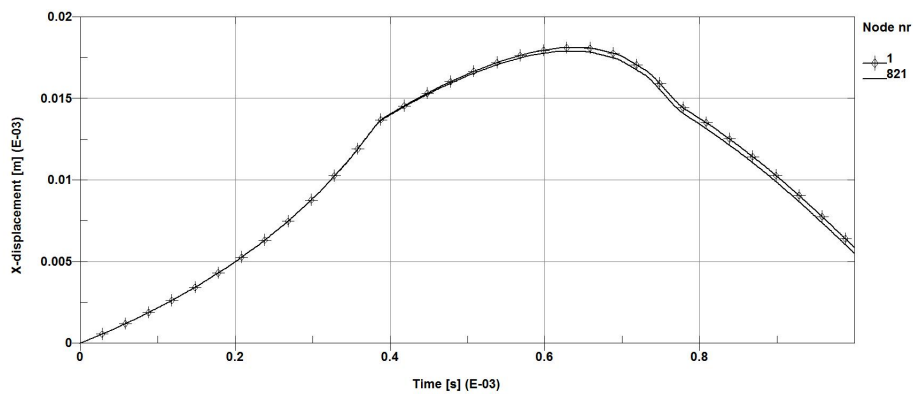

Figure 8.3.3: Displacement for the 1 meter long (point line) rod and for a 0.5 meter long rod (regular line).

In Figure 8.3.3 a small difference between the two rods can be noticed after the reflection at the free end. This difference is small and is neglected in the comparison between the hand calculations and the numerical calculations.

8.4 Results Case Study 4

In this case the ψ -function is changed again, this is in order to avoid materials that are not practical or impossible to use. Therefore, a new function is created with a derivative which is not zero at the end points. This resulted in a new ψ -function which is a third degree polynomial equation.

8.4.1 Hand calculations

The variation of the material properties for the original rod is linear and defined in the same way as in the previous case study. The new ψ -function results in a new set of properties. The variation of the material properties before (curve A) and after (curve B) the transformation can be seen in Figure 8.4.1. It can be seen in the figures that the material properties now correspond better to existing materials, compared to the previous case study. All the hand calculations can be seen in Appendix D.

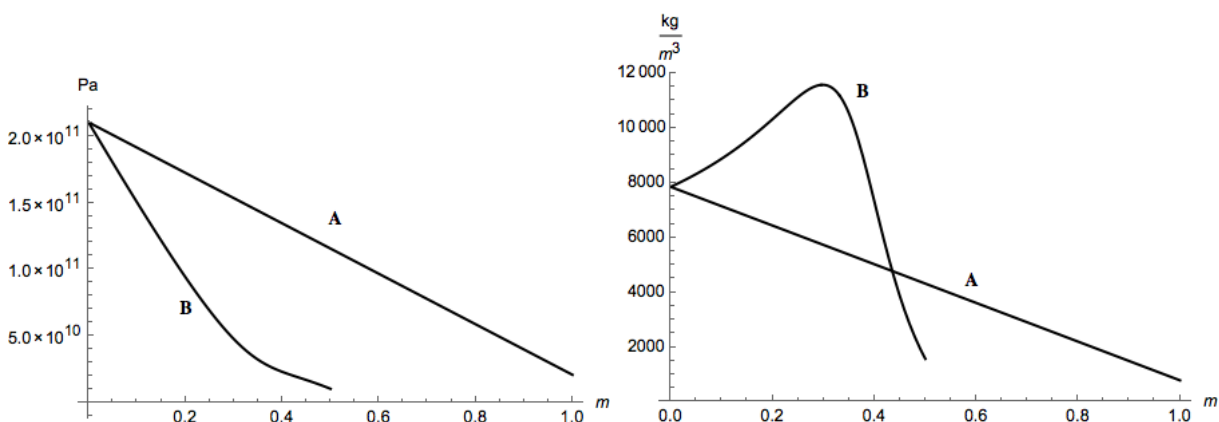

Figure 8.4.1: The variation of Young's modulus and the density before and after transformation.

The wave velocity for the rods are presented in Figure 8.4.2. As seen in the figure the velocities are very different. The reason is the different layer thickness that is needed for the transformed rod.

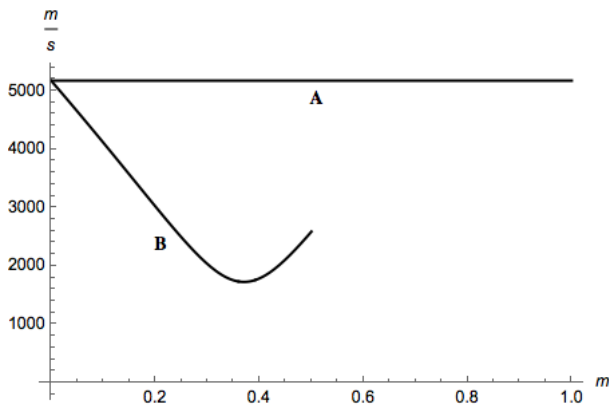

Figure 8.4.2: The wave velocity for the original rod (curve A) and for the transformed rod (curve B).

The properties are taken from the middle of each layer and the new material properties are defined in Table 8.4.1 for the original rod and Table 8.4.2 for the transformed rod. Since the transformation is non-linear the thickness of each layer for the transformed rod needs to be transformed as well, in order for the reflections to occur at the same time.

Table 8.4.1: Material indata for a 1 meter long rod with ten layers.

Layer	Thickness of layer [m]	Young's modulus [GPa]	Density [kg/m ³]	Wave velocity [m/s]
1	0.1	200.55	7496.8	5172
2	0.1	181.65	6790.3	5172
3	0.1	162.75	6083.8	5172
4	0.1	143.85	5377.3	5172
5	0.1	124.95	4670.8	5172
6	0.1	106.05	3964.3	5172
7	0.1	87.15	3257.8	5172
8	0.1	68.25	2551.3	5172
9	0.1	49.35	1844.7	5172
10	0.1	30.45	1138.2	5172

Table 8.4.2: Material indata for a 0.5 meter long rod with ten layers.

Layer	Thickness of layer [m]	Young's modulus [GPa]	Density [kg/m ³]	Wave velocity [m/s]
1	0.0905	181.25	8295.2	4674
2	0.0735	133.29	9254.2	3795
3	0.0595	96.63	1024.6	3071
4	0.0485	69.58	11 116.0	2502
5	0.0405	50.44	11 568.0	2088
6	0.0355	37.51	11 206.0	1830
7	0.0335	29.08	9761.0	1726
8	0.0345	23.46	7421.8	1778
9	0.0385	18.93	4807.2	1985
10	0.0445	13.81	2508.5	2347

Table 8.4.3 and 8.4.4 show the results from the hand calculations. As before the dynamic response of the rods are equal to each other. The tables contain results for both the rods since they are equal.

Table 8.4.3: Stresses for the 1 meter long rod and 0.5 meter long rod with ten different material properties.

Layer	Incident stress, σ_I [MPa]	Reflected stress, σ_R [MPa]	Transmitted stress, σ_T [MPa]
1	0.775	-0.038	0.737
2	0.737	-0.040	0.697
3	0.697	-0.043	0.654
4	0.654	-0.046	0.608
5	0.608	-0.050	0.558
6	0.558	-0.055	0.503
7	0.503	-0.061	0.442
8	0.442	-0.071	0.371
9	0.371	-0.088	0.283
10	0.283	0.283	0.566

Table 8.4.4: Particle velocity for the 1 meter long rod and 0.5 meter long rod with ten different material properties.

Layer	Incident particle velocity, U_{pI} [m/s]	Reflected particle velocity, U_{pR} [m/s]	Transmitted particle velocity, U_{pT} [m/s]
1	0.02	0.001	0.021
2	0.021	0.001	0.022
3	0.022	0.001	0.023
4	0.023	0.002	0.025
5	0.025	0.002	0.027
6	0.027	0.003	0.030
7	0.030	0.004	0.034
8	0.034	0.005	0.039
9	0.039	0.009	0.048
10	0.048	-0.048	0

The transformation with a third degree polynomial gives more reasonable material parameters and the calculations show that the dynamic response is equal between the two rods. However, the calculations become more complicated than before since the transformation is non-linear. This means that the layers must change thickness and are no longer constant.

8.4.2 LS-DYNA calculations

The same material properties are used in the numerical analysis as used in the hand calculations, see Table 8.4.1 and 8.4.2. Both rods are defined in the same model and the modelling procedure is the same as in previous cases. The results from the analysis can be seen in Table 8.4.5 which presents the particle velocity. The dynamic response is equal for the two rods and the results are thereby presented in the same table.

Table 8.4.5: Particle velocity for the 1 meter long rod and 0.5 meter long rod obtained from LS-DYNA.

Layer	Incident particle velocity, U_{pI} [m/s]	Reflected particle velocity, U_{pR} [m/s]	Transmitted particle velocity, U_{pT} [m/s]
1	0.019	0.002	0.021
2	0.021	0.001	0.022
3	0.022	0.001	0.023
4	0.023	0.002	0.025
5	0.025	0.002	0.027
6	0.027	0.002	0.029
7	0.029	0.004	0.033
8	0.033	0.006	0.039
9	0.039	0.009	0.048
10	0.048	-0.048	0

Figure 8.4.3 shows how the displacement varies over time t . The data is extracted from the node where the force is applied (at the free end). It can be seen in the figure that after the reflection at the free end the displacement between the two rods are slightly different.

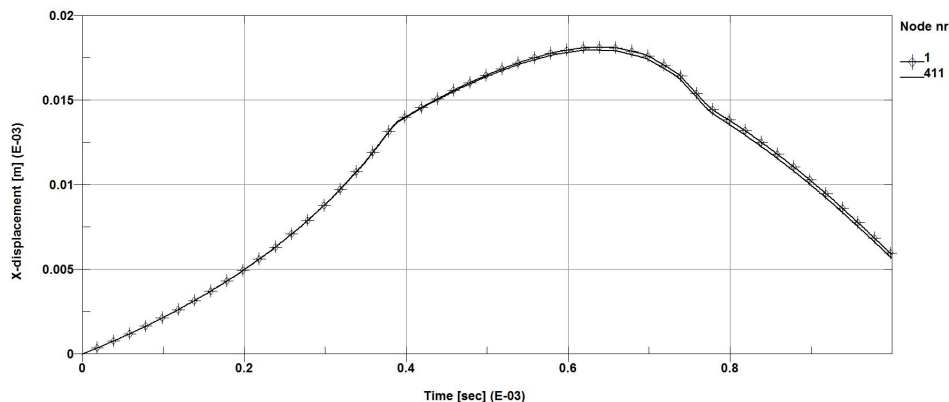

Figure 8.4.3: Displacements for 1 meter long rod with ten layers (point line) and for a 0.5 meter long rod with ten layers (regular line).

The results between hand calculations and numerical analysis are very similar, the difference in the results depends on approximations done in the hand calculations. But the difference is so small that it can be neglected. The ψ -function used in this case study delivers much better properties compared to the function used in the last case study.

8.5 Results Case Study 5

The different cases studies have been performed with theoretical materials and calculated with the theory of transformational elastodynamics. In this case study the transformation will be tested with real materials. The procedure is performed with two different ψ -functions, the linear and the non-linear, in order to be able to compare the different functions. The cross-sectional area, lengths and the applied force are the same as for the other case studies.

The behaviour of the rod is calculated with a code written in MATLAB, see Appendix F. Where the impedance is decreased through the rod. The results from the calculation can be seen in Figure 8.5.1, which shows how the transmitted stress decreases through each layer. The number of layers needed to satisfy this behaviour is 10 and thereby the incident stress is lowered from 100MPa to 17.4MPa, see Figure 8.5.1.

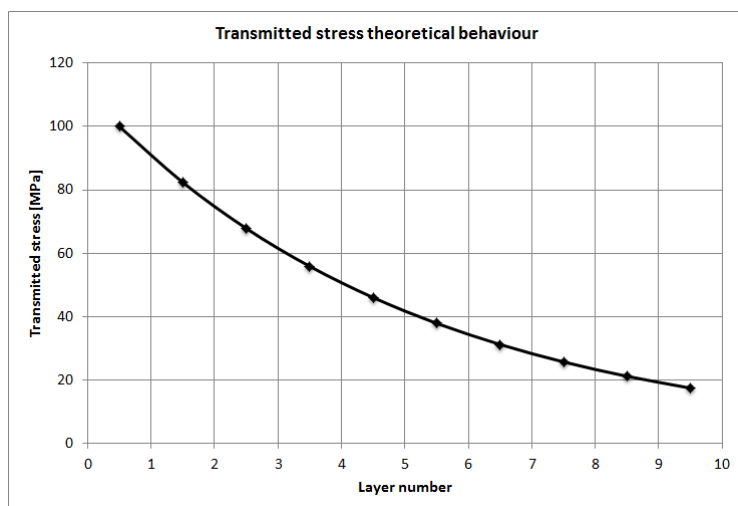

Figure 8.5.1: Theoretically calculated stress variation through the rods.

Figure 8.5.2 shows how the theoretical material properties vary for the 1 meter long rod. An interpolation is made in order to find a function which describes the decrease of Young's modulus and the density. The function are then used in the transformation with the two different functions.

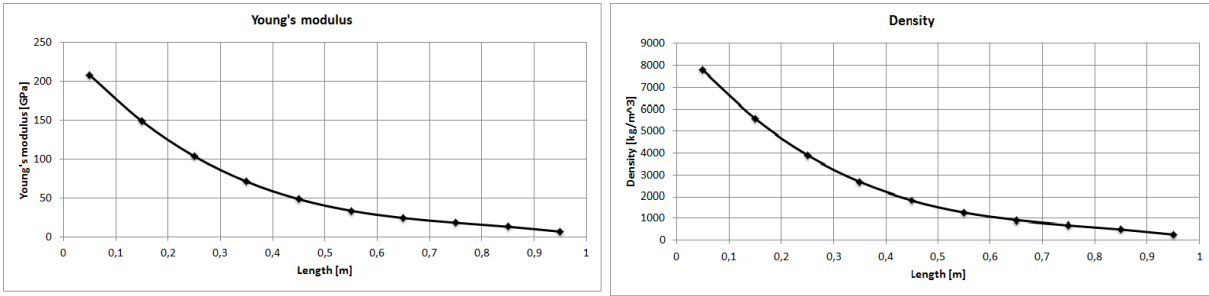

Figure 8.5.2: The variation of Young's modulus and the density to fulfil the calculated behaviour.

The calculated function for the density and Young's modulus are stated in equation (8.5.1) and (8.5.2), the constants are rounded off. These equations are used in the transformation with the two ψ -functions.

$$E(x) = -3.75 \cdot 10^{11}x^3 + 8.94 \cdot 10^{11}x^2 - 7.61 \cdot 10^{11}x + 2.44 \cdot 10^{11} \quad (8.5.1)$$

$$\rho(x) = -1.4 \cdot 10^4x^3 + 3.34 \cdot 10^4x^2 - 2.84 \cdot 10^4x + 0.91 \cdot 10^4 \quad (8.5.2)$$

8.5.1 Calculation with linear ψ

The linear ψ -function is defined in equation (7.1.1), which is the same ψ -function used in the first two case studies. The material properties for the original rod and the transformed rod is presented in Table 8.5.1 and 8.5.2. Figure 8.5.3 presents the variation of the material properties over the length of the rods.

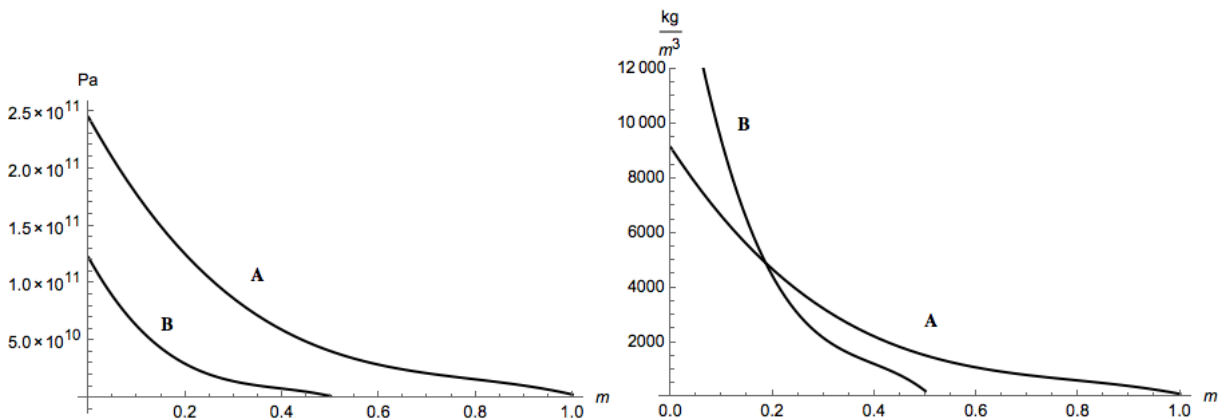

Figure 8.5.3: The variation of Young's modulus and the density before (curve A) and after transformation (curve B).

As seen in Figure 8.5.3, the properties for the original rod follows the curves calculated in MATLAB, see Figure 8.5.2. The properties for the transformed rod is half the Young's modulus and twice the density as for the original rod, which is expected when using the linear ψ -function, see Table 8.5.1 and 8.5.2. The wave velocity for the rods are shown in Figure 8.5.4.

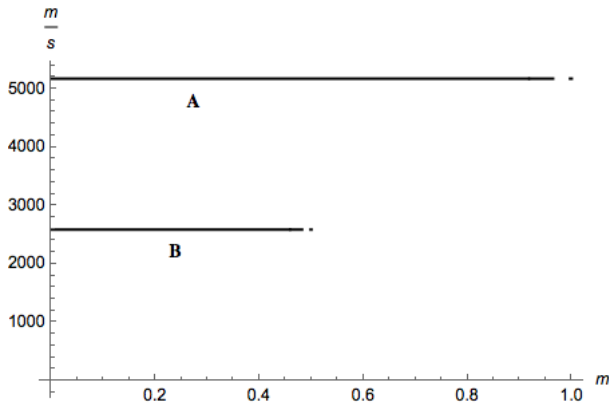

Figure 8.5.4: The wave velocity for the original rod (curve A) and for the transformed rod (curve B).

Table 8.5.1: Material properties for a 1 meter long rod with a linear transformation.

Layer	Thickness of layer [m]	Young's modulus [GPa]	Density [kg/m ³]	Wave velocity [m/s]
1	0.1	208.45	7792.39	5172
2	0.1	149.06	5571.87	5172
3	0.1	104.17	3893.78	5172
4	0.1	71.53	2674.01	5172
5	0.1	48.91	1828.44	5172
6	0.1	34.05	1272.95	5172
7	0.1	24.70	923.404	5172
8	0.1	18.61	695.695	5172
9	0.1	13.53	505.698	5172
10	0.1	7.20	269.291	5172

Table 8.5.2: Material properties for a 0.5 meter long rod with a linear transformation.

Layer	Thickness of layer [m]	Young's modulus [GPa]	Density [kg/m ³]	Wave velocity [m/s]
1	0.05	104.23	15 584.80	2586
2	0.05	74.53	11 143.70	2586
3	0.05	52.08	7787.56	2586
4	0.05	35.77	5348.03	2586
5	0.05	24.46	3656.88	2586
6	0.05	17.03	2545.89	2586
7	0.05	12.35	1846.81	2586
8	0.05	9.31	1391.39	2586
9	0.05	6.76	1011.4	2586
10	0.05	3.60	538.582	2586

Table 8.5.3 and 8.5.4 present the results from the calculation of the transformation. This calculation is performed in order to verify that the transformation is correctly done. The dynamic response of the original rod and the transformed rod are exactly the same, therefore they are presented in the same tables, see Appendix E for calculations.

Table 8.5.3: Stresses in 1 meter long rod and 0.5 long rod with a linear transformation.

Layer	Incident stress, σ_I [MPa]	Reflected stress, σ_R [MPa]	Transmitted stress, σ_T [MPa]
1	0.775	-0.126	0.646
2	0.646	-0.114	0.532
3	0.532	-0.099	0.433
4	0.433	-0.081	0.352
5	0.352	-0.063	0.289
6	0.289	-0.046	0.243
7	0.243	-0.034	0.209
8	0.209	-0.030	0.179
9	0.179	-0.057	0.122
10	0.122	0.122	0.244

Table 8.5.4: Particle velocity in 1 meter long rod and 0.5 long rod a linear transformation.

Layer	Incident particle velocity, U_{PI} [m/s]	Reflected particle velocity, U_{PR} [m/s]	Transmitted particle velocity, U_{PT} [m/s]
1	0.019	0.003	0.022
2	0.022	0.004	0.026
3	0.026	0.005	0.031
4	0.031	0.006	0.037
5	0.037	0.007	0.044
6	0.044	0.007	0.051
7	0.051	0.007	0.058
8	0.058	0.009	0.067
9	0.067	0.021	0.088
10	0.088	-0.088	0

It can be seen in Table 8.5.3 and 8.5.4 that the stresses decrease which increase the particle velocity through each layer.

The calculated material properties for the small rod are implemented in MATLAB. The product between Young's modulus and the density are calculated for the theoretical properties and for the real materials used in the calculation, see Appendix F. A comparison is then made between these values and the materials with the closest value of the product are chosen as a material for the rod. Figure 8.5.5 shows how the density and Young's modulus varies with the chosen materials compared with the theoretically calculated values.

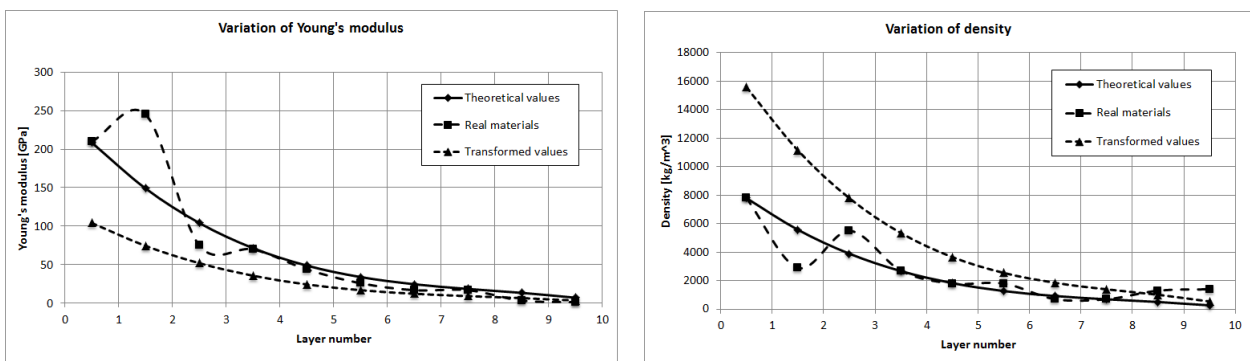

Figure 8.5.5: The transmitted stress calculated for real material compared to the theoretical calculated stress.

The materials which are found for this rod is presented in Table 8.5.5. As can be seen in the table Bamboo is in both layer 6 and 7 which means that no reflected stress will be created in the interface between them. All the materials used in the calculations can be observed in Appendix G.

Table 8.5.5: Materials chosen for the rod.

Material	Young's modulus [GPa]	Density [kg/m ³]
Steel	210	7800
Beryllium alloy	245	2900
Zink alloy	75	5500
Alumina alloy	70	2700
Magnesium alloy	44	1800
GRFP (glass)	26	1800
Bamboo	17	700
Bamboo	17	700
Polyester thermoset	3.5	1300
PVC	1.5	1400

Since the rod with real materials do not have the exact same properties as the theoretically calculated rod the layer thickness need to be changed. The material properties and the layer thickness for the chosen materials are presented in Table 8.5.6.

Table 8.5.6: Material indata for a rod with real material properties.

Layer	Thickness of layer [m]	Young's modulus [GPa]	Density [kg/m ³]	Wave velocity [m/s]
1	0.1003	210.0	7800	5189
2	0.1777	245.0	2900	9191
3	0.0713	75.0	5500	3693
4	0.0984	70.0	2700	5092
5	0.0955	44.0	1800	4944
6	0.0734	26.0	1800	3801
7	0.09527	17.0	700	4928
8	0.09527	17.0	700	4928
9	0.0317	3.5	1300	5189
10	0.020	1.5	1400	1035
$\Sigma = 0.86$				

In order to do a comparison between the theoretical values and the real materials a calculation is performed with the same indata as for the other case studies. The results from the calculations are found in Table 8.5.7 and 8.5.8.

Table 8.5.7: Stresses in the rod with real materials with linear transformation.

Layer	Incident stress, σ_I [MPa]	Reflected stress, σ_R [MPa]	Transmitted stress, σ_T [MPa]
1	0.775	-0.159	0.616
2	0.616	-0.084	0.532
3	0.532	-0.102	0.430
4	0.430	-0.092	0.338
5	0.338	-0.044	0.294
6	0.294	-0.097	0.197
7	0.197	0	0.197
8	0.197	-0.064	0.261
9	0.261	-0.169	0.092
10	0.092	0.092	0.184

Table 8.5.8: Particle velocities in the rod with real materials with linear transformation.

Layer	Incident particle velocity, U_{pI} [m/s]	Reflected particle velocity, U_{pR} [m/s]	Transmitted particle velocity, U_{pT} [m/s]
1	0.019	0.004	0.023
2	0.023	0.003	0.026
3	0.026	0.005	0.031
4	0.031	0.007	0.038
5	0.038	0.005	0.043
6	0.043	0.014	0.057
7	0.057	0	0.057
8	0.057	-0.018	0.039
9	0.039	0.025	0.064
10	0.064	-0.064	0

The stresses and particle velocities for the theoretical and real cases have some differences. This is expected since they should not be perfectly equal due to the material in the database does not have

exactly the same properties as the theoretically calculated values. Because of this difference, layer 6 and forward layers will not have the exact same response. This difference makes the new rod equal to 0.86 meter. To decrease the difference between the rods, where the aim is to transform the rod to 0.5 meters, it is needed to find materials which are closer to the theoretically calculated material values.

Figure 8.5.6 presents the displacements for four different rods. The red curve represents the 1 meter long rod with theoretical material properties and the green curved is the transformed rod. To see the results for the rod with real materials, two more curves can be seen. The blue curve represents the rod where the length was 0.5 meters and the pink curve is the same rod but with changed length to 0.86 meters. The change in lengths makes the reflections occur at the same time as the two theoretical rods and a more similar behaviour is achieved.

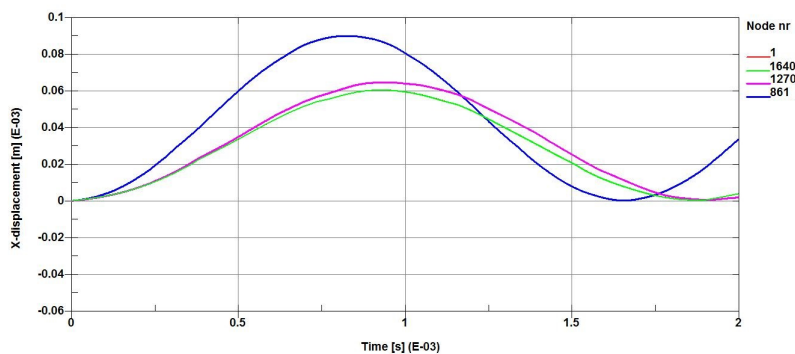

Figure 8.5.6: Displacement for real materials with linear transformation.

A new calculation of the transmitted stress between each layer is done in order to find the real behaviour of the transformed rod. Figure 8.5.7 shows the transmitted stress for the rod with real materials compared to the theoretically calculated transmitted stress. The calculations show that the transmitted stress is lowered from 100 MPa to 15.7 MPa. As seen in the figure and in the table above, between layer six and seven the stress does not decrease. This means that both of these layers have the same material properties, and therefore no reflection will occur. If more materials are added to the list this problem can be avoided.

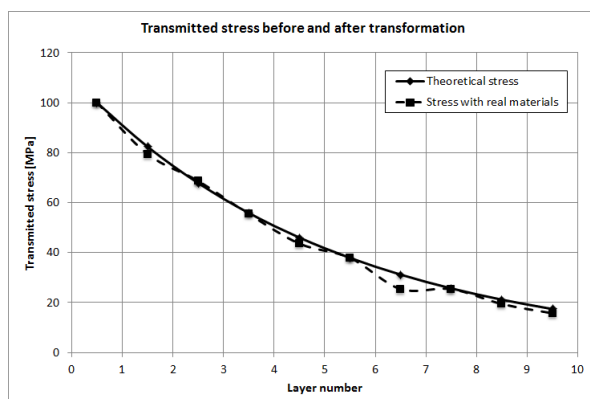

Figure 8.5.7: Transmitted stress with real materials compared to the theoretically calculated transmitted stress.

8.5.2 Calculation with non-linear ψ

The ψ -function used in this calculations is the third degree polynomial equation, stated in equation (7.4.1). The material properties for the original rod is the same as in the case with the linear ψ -function and can be seen in Table 8.5.1. The material properties for the transformed rod can be seen in Table 8.5.9 and the variation of the material properties over the length can be seen in Figure 8.5.8, where the original rods is curve A and transformed rod is curve B.

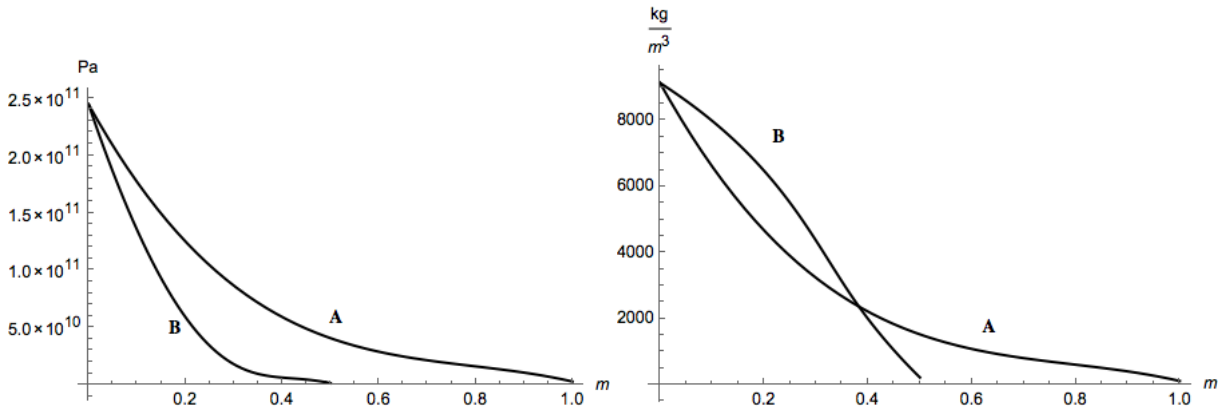

Figure 8.5.8: The variation of Young's modulus and the density before and after transformation.

The transformation is non-linear, which means that the transformed rod is not half Young's modulus and twice the density as for the linear case. The wave velocity for the original and transformed rod are presented in Figure 8.5.9.

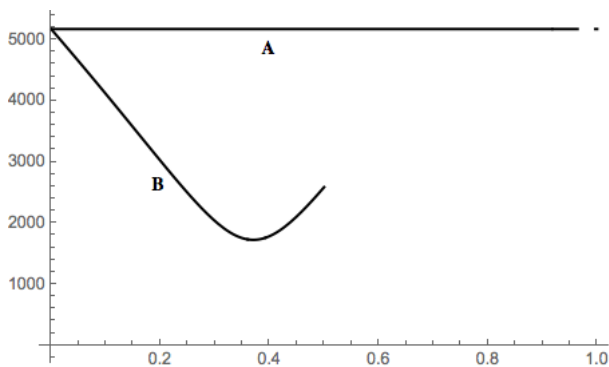

Figure 8.5.9: The wave velocity for the original rod (curve A) and for the transformed rod (curve B).

The material properties and the layer thickness for the transformed rod is presented in Table 8.5.9.

Table 8.5.9: Material indata for a 0.5 meter long rod with non-linear transformation.

Layer	Thickness of layer [m]	Young's modulus [GPa]	Density [kg/m ³]	Wave velocity [m/s]
1	0.0905	188.40	8622.3	4674
2	0.0735	109.37	7593.7	3795
3	0.0595	61.85	6557.9	3071
4	0.0485	34.60	5527.7	2502
5	0.0405	19.75	4528.7	2088
6	0.0355	12.05	3598.4	1830
7	0.0335	8.24	2766.8	1726
8	0.0345	6.40	2023.8	1778
9	0.0385	5.19	1317.8	1985
10	0.0445	3.27	593.5	2347

As seen in Table 8.5.9 the thickness of the layers are no longer constant and the material properties vary in a different way compared to the case with the linear ψ -function. The wave velocity differs between the two cases which are the reason for the different layer thickness in this case.

Table 8.5.10 shows the calculated stresses and particle velocities for the transformed rod, this in order to make a comparison between the theoretical and real materials. Since the stresses is equal for the two rod the results are presented in the same table.

Table 8.5.10: Stresses for the 1 meter and 0.5 meter long rod with non-linear transformation.

Layer	Incident stress, σ_I [MPa]	Reflected stress, σ_R [MPa]	Transmitted stress, σ_T [MPa]
1	0.775	-0.129	0.646
2	0.0646	-0.114	0.532
3	0.532	-0.099	0.433
4	0.433	-0.081	0.352
5	0.352	-0.063	0.289
6	0.289	-0.046	0.243
7	0.243	-0.034	0.209
8	0.209	-0.033	0.179
9	0.179	-0.057	0.122
10	0.122	0.122	0.244

Table 8.5.11: Particle velocity for the real materials with non-linear transformation.

Layer	Incident particle velocity, U_{pI} [m/s]	Reflected particle velocity, U_{pR} [m/s]	Transmitted particle velocity, U_{pT} [m/s]
1	0.019	0.003	0.022
2	0.022	0.004	0.026
3	0.026	0.005	0.031
4	0.031	0.006	0.037
5	0.037	0.007	0.044
6	0.044	0.007	0.051
7	0.051	0.007	0.058
8	0.058	0.009	0.067
9	0.067	0.021	0.088
10	0.088	-0.088	0

It can be seen that the stresses and particle velocity for the linear and non-linear case are exactly the same. This means that they will behave in the same way to decrease the stress wave. This is expected since they both have been transformed to a 0.5 meter long rod. The product of Young's modulus and density are therefore equal. The difference between them is the material properties.

In order to find the real material properties in this case the same procedure is done as for the case with the linear ψ -function. The results from the calculations are shown in Figure 8.5.10.

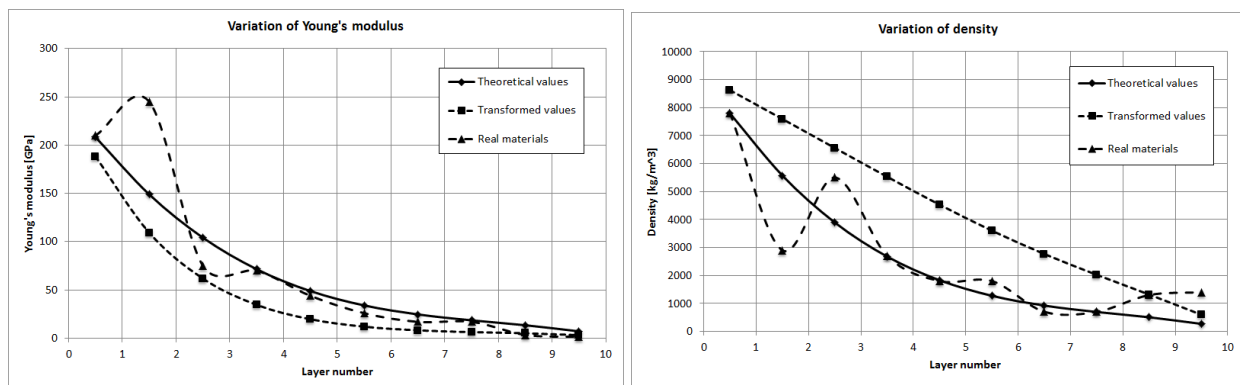

Figure 8.5.10: The transmitted stress calculated for real material compared to the theoretical calculated stress.

As seen in the Figure 8.5.10 the exact same materials as for the transformation with the linear ψ -function is calculated. This is because the product between Young's modulus and the density needs to be the same between the original rod and the transformed rod. This means that the two transformations gives the same product and thereby the same materials. The results for the calculations of the real materials are presented in Table 8.5.7 and 8.5.8.

Since the same materials are used in the both cases the transmitted stress will behave in the same manner as in the first case with the linear ψ -function, see Figure 8.5.11.

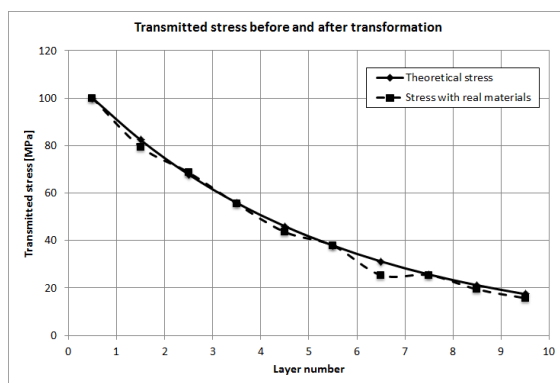

Figure 8.5.11: Transmitted stress with real materials compared to the theoretically calculated transmitted stress.

In theory, the two ψ -functions generate different material properties and layer thickness. Although, the real materials becomes the same for both cases. If there is more materials added on the list the theoretically calculated properties can be fulfilled. Then in a design situation one of the functions may give better materials to work with. A better way to find the real materials is to do the optimization on the density and Young's modulus individually and not on the product. This will also increase the accuracy of the calculation and thereby come close to the theoretical values.

Even if the aim of creating a 0.5 meter long rod was not fulfilled the length decreased to 0.86 meter is

still a considerable decrease. It can also be seen that the transmitted stress decreases about 85% by using many layers to lower the amplitude of the stress wave.

9 Discussion

The discussion chapter is divided into several sections where the authors discuss the different case studies and how to improve the method in order to produce a design that works with real materials.

Case study 1

The first case study was done in order to learn how the theory of transformational elastodynamics works and see if the theory can be applied for a structural element. A simple case was chosen to just verify the theory. The results show that the method works very well and it is possible to change the geometry and material properties and still have the same dynamic response. However, this was a simple case and the stresses are constant through the rod. The damping calculated in LS-DYNA shows that the influence of the damping is low, however to define the damping coefficients needed to get accuracy in the results is difficult. According to the literature the damping can be neglected in this type of problems.

Case study 2

Since the aim was to create a structure which can lower the transmitted stress the rod was divided into ten layers, each layer with new material properties. The Young's modulus was constantly decreasing and the density constantly increasing. They were chosen to behave in this manner in order to see what dynamic response the rods would have when the properties constantly change. The transmitted stress did not constantly decrease through the rod with these material properties, instead it increased due to the impedance increasing. This is the reason both density and Young's modulus constantly decrease in the latter case studies. But the dynamic response is equal for both the rods.

It can be noticed from this case study that if the impedance is equal between each layer the transformation is working.

Case study 3 and 4

For case study 3 another ψ -function was tested, the material properties calculated with this function were unreasonable when they were compared to real materials. Therefore, the function was changed to case study 4.

As seen in both cases the displacements from the calculations in LS-DYNA differ a bit from the two rods. The wave hit the fixed boundary at approximately $0.2 \cdot 10^{-3}$ seconds. The wave gets totally reflected with the same sign as before which results in the increased displacement. At approximately $0.4 \cdot 10^{-3}$ seconds, the wave hits the free end where the force was applied and the stress wave changes sign. At this point the displacement differs between the two cases. This difference might depend on the input data in LS-DYNA where the input data cannot be as exact as the hand calculations. Therefore, the results differ after a couple of reflections. However, the difference is very small.

The two case studies gives the same results with the two transformation functions. This is because same indata is used for the original rod. As mentioned before the impedance needs to be equal between the original rod and transformed rod. This means that the impedance is going to be independent of the transformation function. The difference is the thickness of the layers and specific parameters which fulfil the impedance.

Case study 5

The study proves that it is possible to create a rod which is smaller than the original design with existing materials. Although, the transformed length of 0.5 meter could not be reached but a length of 0.86 meter is still a considerable decrease. This error depends on the chosen materials do not fulfil the exact theoretical values. This means that the layer thickness need to be changed in order for the reflections to happen at the same time, the new layer thickness is not calculated with the ψ -function but extracted from the wave velocity equation in order to see after how long time the reflection should occur. The calculations give many digits and are rounded off, which means that the response will be a bit different. However, the list of materials used in the project was small and by increasing the number of materials it can be possible to come closer to the theoretical values. Also, due to the small database of materials, the materials are chosen after the product of Young's modulus and the density. A better way to do the optimization of the real materials is to optimize on Young's modulus and the density individually.

ψ -functions

The ψ -function has a great influence of the material properties and thickness of the layers. The material properties can vary much and be impossible to fulfil in reality even if it is working in the theory. Therefore, three different functions have been tried in order to see a difference between them and hopefully find a function which results in reasonable materials. These functions may not be the most optimal and more functions are needed to be tried out in order to find a suitable solution.

There are values that need to be avoided when constructing the ψ -function. The function can not have a derivative close to zero or going to infinity. If this happens the material properties will go towards zero or infinity which is not realistic. This was not considered when designing the first two ψ -functions which resulted in very large or small values for Young's modulus or the density. In the third ψ -function this was taken into consideration and as a result good values were received, which correspond to existing materials. However, the calculations become more complex when choosing a higher order ψ -function.

When the ψ -function is no longer linear the thickness of each layer will not be constant as in the case of a linear function. In order to have the same response in the two rods the incident wave needs to be reflected at the same time, when the ψ -function is non-linear the wave velocity will not be halved in each layer compared to the original rod. Therefore, it is needed to adjust the layer thickness so the reflections happen at the same time. When designing a structure with this method it is therefore important to check if all the layers have a thickness which is possible to construct.

Model

The material properties play a huge roll in this concept of design, especially the product between Young's modulus and the density. This product needs to be equal between the two rods in order for the transformation to work. This also means that it is possible to choose any materials which fulfil this, but the layer thickness will be different for each set of materials. By using the transformation technique it is easier to decide and find the material properties which fulfil the design requirements.

The lengths and the force of the rods are chosen to be the same in all case studies. This is in order to be able to do a comparison between the different cases and thereby improve the models. The thickness of the layers and lengths are chosen to make the calculations easier and prove the theory. In real design the length of the structure can be changed to better suit the reality.

10 Conclusions

The purpose with the thesis was to increase the knowledge about wave propagation between different materials. The literature study covers the basics of this phenomenon, with explanations and derivations of common equations. The study focus on elastic stress waves and the theory of transformational elastodynamics which is used later in the thesis in order to design a rod which can reduce the amplitude of the stress wave considerably. The aim with the thesis was to combine the theory of elastic wave propagation and transformational elastodynamics in order to be able to design a small strengthening structure which decrease the stress amplitude of the incident wave.

The theory of elastic wave where the stress amplitude is constantly decreased through the rod is feasible on simple cases. Combined with the theory of transformational elastodynamics the geometry of the rods can be transformed into a smaller rod with the same dynamic response. However, in order for the transformation to work the impedance need to be the same for the original and transformed rod.

The theory has only been tested for one type of rod which is fixed in one end and free at the other end. ψ -functions used in the calculations is not optimized for each case, they are written by the authors in order to find a difference between them. It is needed to optimize the transformation in order to keep costs and materials to a minimum, which is not taken into consideration.

The result from the last case study shows that it is possible to construct a smaller rod with real material properties with the same dynamic response. However, to increase the accuracy of the results more materials need to be added to the calculations. Also, optimize on Young's modulus and the density individually instead of the product between them will increase the accuracy of the results.

Further Studies

In the project several different ψ -functions were used in the calculations in order to find the material parameters for the transformed rod, these functions are only chosen by the authors in order to find a difference between the functions. Another theory which is similar to transformational elastodynamics is wave splitting. Wave splitting is a more general way to solve the transformation between the rods. With wave splitting it is possible to formulate conditions in order to optimize the calculations for each case.

Furthermore, the tests carried out in the project are with one dimensional elastic waves which do not cause any permanent damage to the material. A blast or a high velocity impact creates plastic waves or even a shock wave in the material. This phenomenon creates other waves in the material such as shear waves and Rayleigh waves which are needed to be taken into consideration. The calculations also need to be extended to two- and three dimensions in order to verify the real behaviour. The responses of the rods are only theoretical and therefore laboratory testing is necessary in order to find if the method works in reality.

The method can also be extended to more fields than just structural engineering, for example this can be used in the car industry, helmets and other parts where space and dynamic problems are a problem.

11 References

Craig, R. and Kurdila, A. (2006) *Fundamentals of structural dynamics*. Second edition. New York: John Wiley & Sons, Inc

Ellobody, E. Feng, R. and Young, B. (2014) *Finite Element Analysis and Design of Metal Structures* Amsterdam: Elsevier inc

Johansson, M. (2012) *Luftstötövåg*. [Electronic] Myndigheten för samhällskydd och beredskap. (Report: MSB448)

Lempriere, M. (2002) *Ultrasound and Elastic Waves: Frequently Asked Questions*. [Elektronik] Amsterdam: Academic Press

Leppänen, J. (2012) *Splitterverkan*. [Electronic] Myndigheten för samhällskydd och beredskap. (Report: MSB345)

Leppänen, J. (2002) *Dynamic Behaviour of Concrete Structures subjected to Blast and Fragment Impacts*. [Electronic] Gothenburg: Chalmers University of Technology

Lifshitz, et alii. (2001) *Handbook of shock waves*. [Electronic] Volume 3. Burlington: Academic press

Macaulay, M. (1987) *Introduction to impact engineering*. [Electronic] New York: Chapman and Hall Ltd

Meyers, Marc A. (1994) *Dynamic behavior of materials*. New York: John Wiley & Sons, Inc

Plos, M. Broo, H. and Lundgren, K. (2008) *Guide to nonlinear modelling* Gothenburg: Chalmers University of Technology

Zukas, J. (1990) *High velocity impact dynamics*. New York: John Wiley & Sons, Inc

Figure references

Picture of a Rayleigh wave [Electronic figure] https://en.wikipedia.org/wiki/Rayleigh_wave#/media/File:Rayleigh_wave.jpg [Access 2015-04-10]

Plane P-wave [Electronic figure] https://en.wikipedia.org/wiki/P-wave#/media/File:Onde_compression_impulsion_1d_30_petit.gif [Access 2015-04-10]

Plane shear wave [Electronic figure] https://en.wikipedia.org/wiki/S-wave#/media/File:Onde_cisaillement_impulsion_1d_30_petit.gif [Access 2015-04-10]

A Material properties and dynamic response calculations, Case study 1

Transformation with x-function (linear), Case study 1

Following calculations are made with the theory of elastic wave propagation between different materials. This is done in order to compare two Rods (A and B) with different lengths and material parameters. Stresses and particle velocity for initial waves will be determine and presented below.

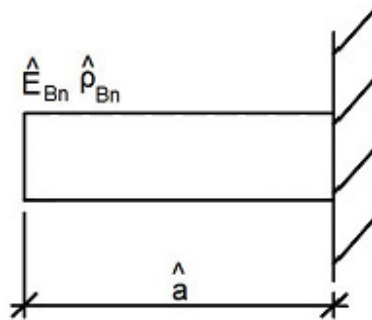
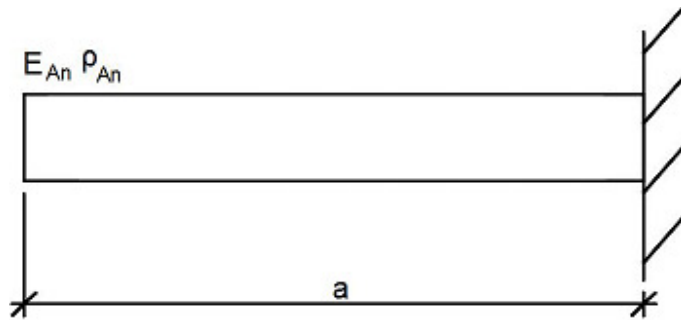

Material parameters Rod A

Young's modulus:

$$E_{A1} := 2.10 \cdot 10^{11} \cdot \text{Pa}$$

Density:

$$\rho_{A1} := 7850 \cdot \frac{\text{kg}}{\text{m}^3}$$

Wave velocity:

$$c_{A1} := \sqrt{\frac{E_{A1}}{\rho_{A1}}} = 5.172 \times 10^3 \frac{\text{m}}{\text{s}}$$

Material parameters Rod B

Young's modulus:

$$E_{B1} := 1.05 \cdot 10^{11} \cdot \text{Pa}$$

Density:

$$\rho_{B1} := 15700 \cdot \frac{\text{kg}}{\text{m}^3}$$

Wave velocity:

$$c_{B1} := \sqrt{\frac{E_{B1}}{\rho_{B1}}} = 2.586 \times 10^3 \frac{\text{m}}{\text{s}}$$

Stresses in Rod A

$$F := 500\text{N}$$

Force at the left end of the Rod A and B

$$A := 6.450 \cdot 10^{-4} \text{ m}^2$$

Cross section area of Rod A and B

Layer 1:

$$\sigma_{I1} := \frac{F}{A} = 0.775 \cdot \text{MPa}$$

Initial stress wave of Rod A

$$U_{PI.A1} := \frac{\sigma_{I1}}{\rho_{A1} \cdot c_{A1}} = 0.019 \frac{\text{m}}{\text{s}}$$

Initial stress wave of Rod

Stresses in Rod B

Layer 1:

$$\sigma_{B1.I} := \sigma_{I1} = 0.775 \cdot \text{MPa}$$

Initial stress wave of Rod B

$$U_{PI.B1} := \frac{\sigma_{B1.I}}{\rho_{B1} \cdot c_{B1}} = 0.019 \frac{\text{m}}{\text{s}}$$

Initial stress wave of Rod B

B Material properties and dynamic response calculations, Case study 2

Calculation of material parameters for case studie two and plots

Defines the psi functions and calculating beta(x)

```
poly[x_] :=  $\frac{0.5}{1} * x$   
Solve[ $\frac{0.5}{1} * x == y, x$ ]  
{ {x → 2. y} }
```

```
invpoly[x_] := 2 x
```

```
 $\psi$  = poly
```

```
poly
```

```
 $\psi$ inv = invpoly
```

```
invpoly
```

```
 $\beta$ [x_] :=  $\psi'$  [ $\psi$ inv[x]]
```

Defines the material functions for Young's modulus and the density

```
ClearAll[E0,  $\rho$ 0]; E0 = 210. × 109;  $\rho$ 0 = 7850.;
```

```
Emod[x_] :=  $\left(1 - \frac{x}{1}\right) * E0$ 
```

```
 $\rho$ [x_] :=  $\rho$ 0 *  $\frac{x}{1}$ 
```

Plots the different material curves for the material properties and the wave velocity

```
A = Plot[Emod[x], {x, 0, 1}, PlotStyle → GrayLevel[0],  
AxesOrigin → {0, 0}, AxesLabel → {m, Pa}, LabelStyle → {Black}]
```

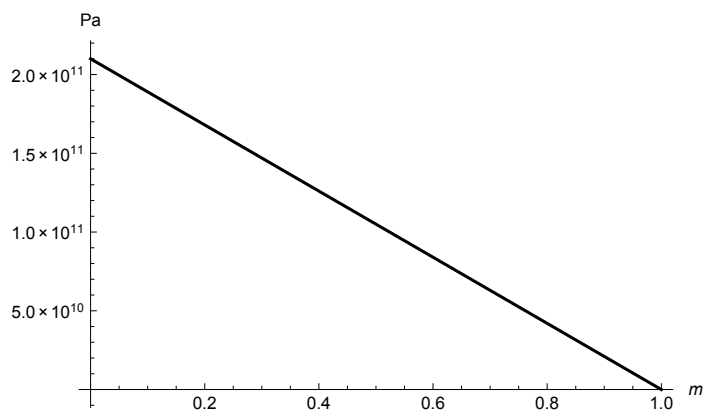

```
B = Plot[ $\rho[x]$ , {x, 0, 1}, PlotStyle  $\rightarrow$  GrayLevel[0], AxesOrigin  $\rightarrow$  {0, 0},  
PlotRange  $\rightarrow$  {15 000, 0}, AxesLabel  $\rightarrow$  {m, kg/m3}, LabelStyle  $\rightarrow$  {Black}]
```

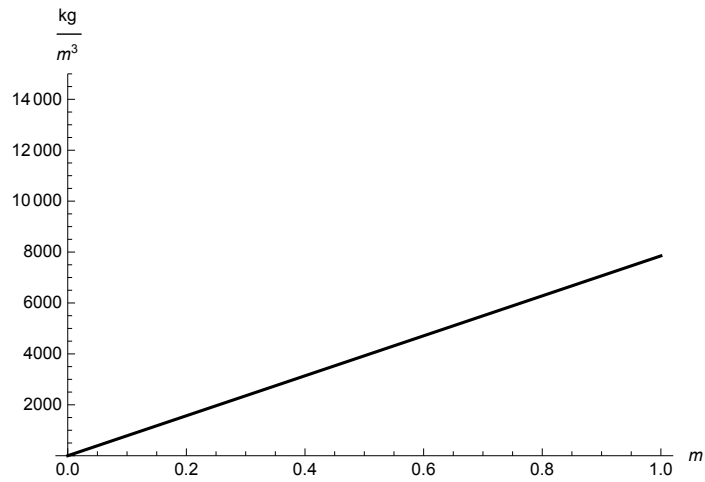

```
Plot[ $\beta[x]$ , {x, 0, 1}, PlotStyle  $\rightarrow$  GrayLevel[0], AxesOrigin  $\rightarrow$  {0, 0}]
```

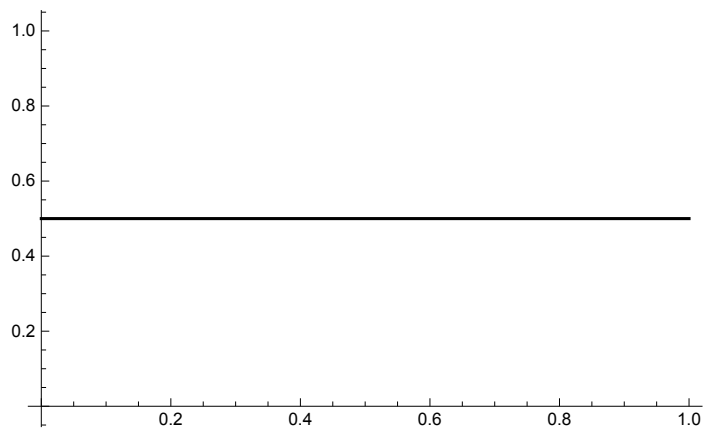

```
AB = Plot[Emod[ $\psi$ inv[x]]  $\beta[x]$ , {x, 0, 0.5},  
PlotStyle  $\rightarrow$  GrayLevel[0], AxesOrigin  $\rightarrow$  {0, 0}]
```

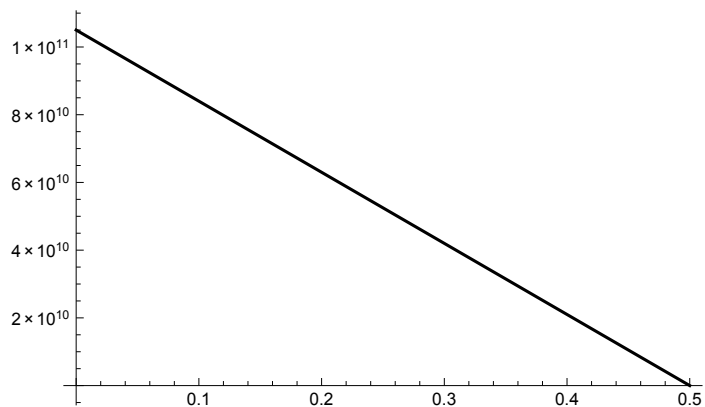

```
R = Plot[ $\frac{\rho[\psi\text{inv}[x]]}{\beta[x]}$ , {x, 0, 0.5}, PlotStyle -> GrayLevel[0], AxesOrigin -> {0, 0}]
```

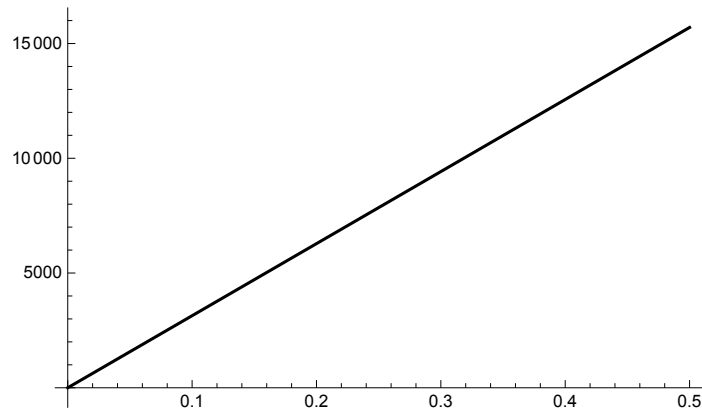

```
Plot[psiinv[x], {x, 0, 1}, AxesOrigin -> {0, 0}]
```

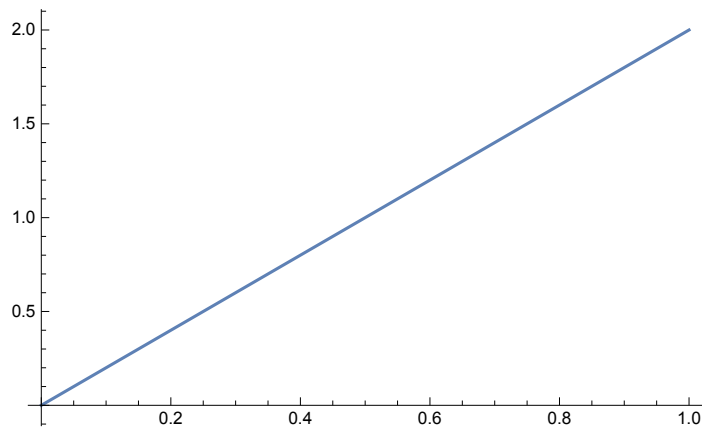

```
vell = Plot[ $\sqrt{\frac{\text{Emod}[x]}{\rho[x]}}$ , {x, 0, 1}, PlotStyle -> GrayLevel[0],  
AxesOrigin -> {0, 0}, AxesLabel -> {m, m / s}, LabelStyle -> {Black}]
```

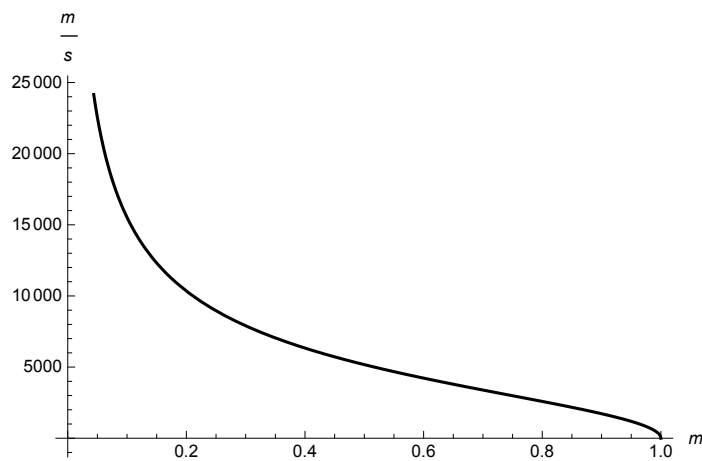

```
vel2 = Plot[ $\sqrt{\frac{\text{Emod}[\psi\text{inv}[\mathbf{x}]] \beta[\mathbf{x}]}{\frac{\rho[\psi\text{inv}[\mathbf{x}]]}{\beta[\mathbf{x}]}}}$ ,
  {x, 0, 0.5}, PlotStyle -> GrayLevel[0], AxesOrigin -> {0, 0}]
```

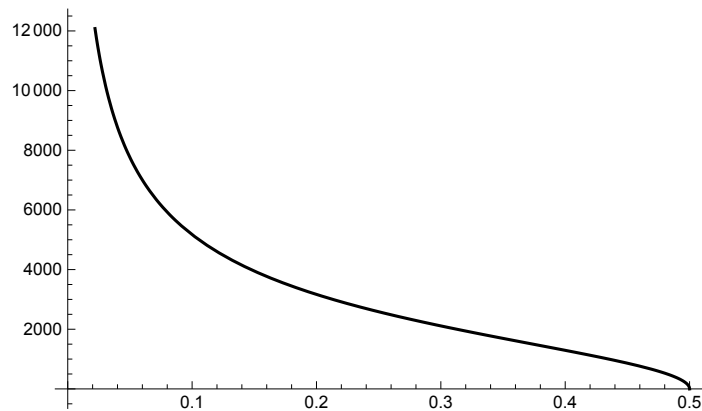

Calculating the material properties from the curves for the transformed and original rods.

```
MatrixForm[Table[
  {x, x + 0.05, Emod[x], ρ[x], Emod[x] ρ[x],  $\sqrt{\frac{\text{Emod}[\mathbf{x}]}{\rho[\mathbf{x}]}}$ }, {x,  $\frac{0.1}{2}$ ,  $1 - \frac{0.1}{2}$ , 0.1}]]]
```

0.05	0.1	1.995×10^{11}	392.5	7.83038×10^{13}	22545.1
0.15	0.2	1.785×10^{11}	1177.5	2.10184×10^{14}	12312.3
0.25	0.3	1.575×10^{11}	1962.5	3.09094×10^{14}	8958.5
0.35	0.4	1.365×10^{11}	2747.5	3.75034×10^{14}	7048.51
0.45	0.5	1.155×10^{11}	3532.5	4.08004×10^{14}	5718.08
0.55	0.6	9.45×10^{10}	4317.5	4.08004×10^{14}	4678.43
0.65	0.7	7.35×10^{10}	5102.5	3.75034×10^{14}	3795.35
0.75	0.8	5.25×10^{10}	5887.5	3.09094×10^{14}	2986.17
0.85	0.9	3.15×10^{10}	6672.5	2.10184×10^{14}	2172.76
0.95	1.	1.05×10^{10}	7457.5	7.83037×10^{13}	1186.58

```
MatrixForm[Table[{x, ψ[x], β[ψ[x]] Emod[ψinv[ψ[x]]],
   $\frac{\rho[\psi\text{inv}[\psi[\mathbf{x}]]]}{\beta[\psi[\mathbf{x}]]}$ , β[ψ[x]] Emod[ψinv[ψ[x]]]  $\frac{\rho[\psi\text{inv}[\psi[\mathbf{x}]]]}{\beta[\psi[\mathbf{x}]]}$ ,
   $\sqrt{\frac{\beta[\psi[\mathbf{x}]] \text{Emod}[\psi\text{inv}[\psi[\mathbf{x}]]]}{\frac{\rho[\psi\text{inv}[\psi[\mathbf{x}]]]}{\beta[\psi[\mathbf{x}]]}}}$ }, {x,  $\frac{0.1}{2}$ ,  $1 - \frac{0.1}{2}$ , 0.1}]]]
```

0.05	0.025	9.975×10^{10}	785.	7.83038×10^{13}	11272.5
0.15	0.075	8.925×10^{10}	2355.	2.10184×10^{14}	6156.14
0.25	0.125	7.875×10^{10}	3925.	3.09094×10^{14}	4479.25
0.35	0.175	6.825×10^{10}	5495.	3.75034×10^{14}	3524.26
0.45	0.225	5.775×10^{10}	7065.	4.08004×10^{14}	2859.04
0.55	0.275	4.725×10^{10}	8635.	4.08004×10^{14}	2339.21
0.65	0.325	3.675×10^{10}	10205.	3.75034×10^{14}	1897.68
0.75	0.375	2.625×10^{10}	11775.	3.09094×10^{14}	1493.08
0.85	0.425	1.575×10^{10}	13345.	2.10184×10^{14}	1086.38
0.95	0.475	5.25×10^9	14915.	7.83037×10^{13}	593.291

Plotting the final plots which shows the transformed and original values for Young's modulus the

density and the wave velocity

`emoduler = Show[A, AB]`

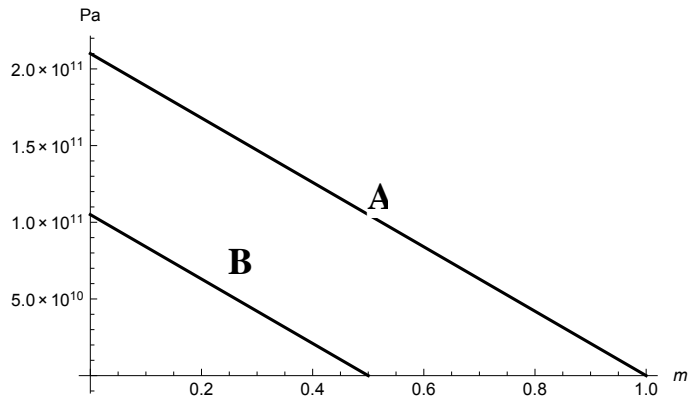

`densitet = Show[B, R]`

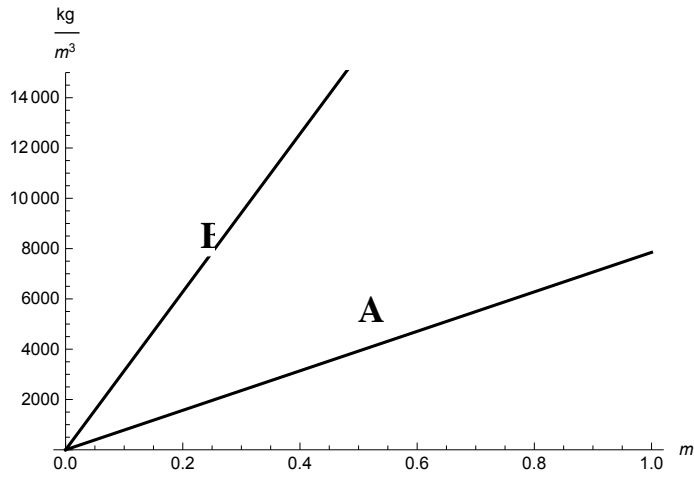

`velocity = Show[vel1, vel2]`

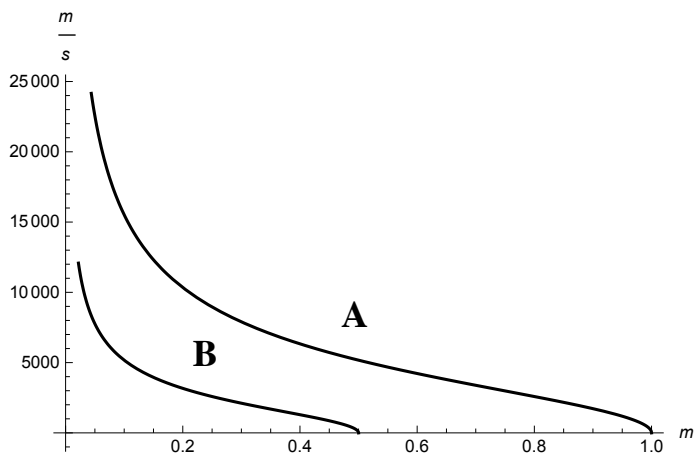

Transformation with x³-function, Case Study 5

Following calculations are made with the theory of elastic wave propagation between different materials. This is done in order to compare two Rods (A and B) with different lengths and material parameters. Stresses and particle velocity for incident, reflected and transmitted waves will be determine and presented below.

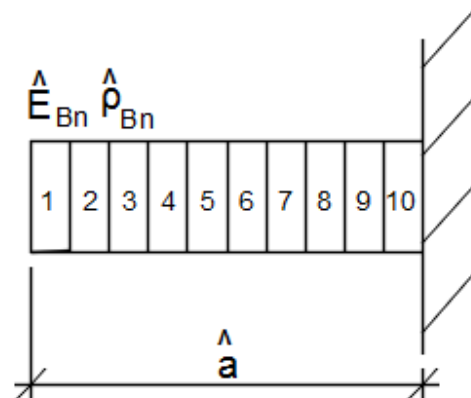
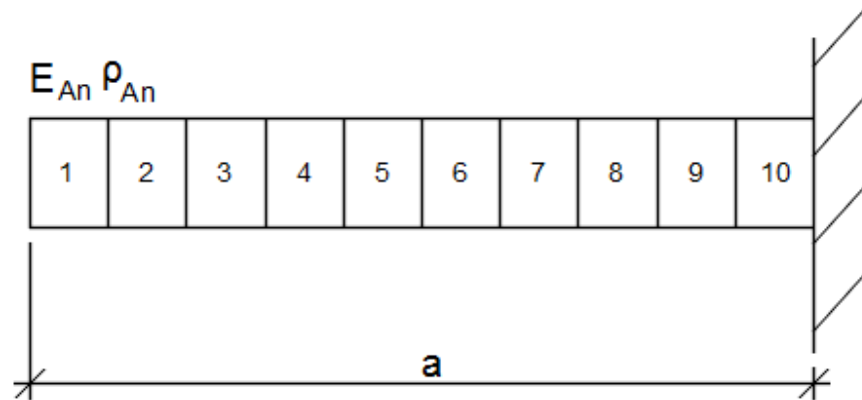

Material parameters Rod A

Material parameters has been calculated in mathematica

Young's modulus:

Density:

Wave velocity:

$$E_{A1} := 199.5 \cdot 10^9 \cdot \text{Pa}$$

$$\rho_{A1} := 392.5 \cdot \frac{\text{kg}}{\text{m}^3}$$

$$c_{A1} := \sqrt{\frac{E_{A1}}{\rho_{A1}}} = 2.255 \times 10^4 \frac{\text{m}}{\text{s}}$$

$$E_{A2} := 178.5 \cdot 10^9 \cdot \text{Pa}$$

$$\rho_{A2} := 1177.5 \cdot \frac{\text{kg}}{\text{m}^3}$$

$$c_{A2} := \sqrt{\frac{E_{A2}}{\rho_{A2}}} = 1.231 \times 10^4 \frac{\text{m}}{\text{s}}$$

$$E_{A3} := 157.5 \cdot 10^9 \cdot \text{Pa}$$

$$\rho_{A3} := 1962.5 \cdot \frac{\text{kg}}{\text{m}^3}$$

$$c_{A3} := \sqrt{\frac{E_{A3}}{\rho_{A3}}} = 8.959 \times 10^3 \frac{\text{m}}{\text{s}}$$

$E_{A4} := 136.5 \cdot 10^9 \cdot \text{Pa}$	$\rho_{A4} := 2747.5 \cdot \frac{\text{kg}}{\text{m}^3}$	$c_{A4} := \sqrt{\frac{E_{A4}}{\rho_{A4}}} = 7.049 \times 10^3 \frac{\text{m}}{\text{s}}$
$E_{A5} := 115.5 \cdot 10^9 \cdot \text{Pa}$	$\rho_{A5} := 3532.5 \cdot \frac{\text{kg}}{\text{m}^3}$	$c_{A5} := \sqrt{\frac{E_{A5}}{\rho_{A5}}} = 5.718 \times 10^3 \frac{\text{m}}{\text{s}}$
$E_{A6} := 94.5 \cdot 10^9 \cdot \text{Pa}$	$\rho_{A6} := 4317.5 \cdot \frac{\text{kg}}{\text{m}^3}$	$c_{A6} := \sqrt{\frac{E_{A6}}{\rho_{A6}}} = 4.678 \times 10^3 \frac{\text{m}}{\text{s}}$
$E_{A7} := 73.5 \cdot 10^9 \cdot \text{Pa}$	$\rho_{A7} := 5102.5 \cdot \frac{\text{kg}}{\text{m}^3}$	$c_{A7} := \sqrt{\frac{E_{A7}}{\rho_{A7}}} = 3.795 \times 10^3 \frac{\text{m}}{\text{s}}$
$E_{A8} := 52.5 \cdot 10^9 \cdot \text{Pa}$	$\rho_{A8} := 5887.5 \cdot \frac{\text{kg}}{\text{m}^3}$	$c_{A8} := \sqrt{\frac{E_{A8}}{\rho_{A8}}} = 2.986 \times 10^3 \frac{\text{m}}{\text{s}}$
$E_{A9} := 31.5 \cdot 10^9 \cdot \text{Pa}$	$\rho_{A9} := 6672.5 \cdot \frac{\text{kg}}{\text{m}^3}$	$c_{A9} := \sqrt{\frac{E_{A9}}{\rho_{A9}}} = 2.173 \times 10^3 \frac{\text{m}}{\text{s}}$
$E_{A10} := 10.5 \cdot 10^9 \cdot \text{Pa}$	$\rho_{A10} := 7457.5 \cdot \frac{\text{kg}}{\text{m}^3}$	$c_{A10} := \sqrt{\frac{E_{A10}}{\rho_{A10}}} = 1.187 \times 10^3 \frac{\text{m}}{\text{s}}$

Stresses in Rod A

$$F := 500\text{N}$$

Force at the left end of the Rod A and B

$$A := 6.450 \cdot 10^{-4} \text{ m}^2$$

Cross section area of Rod A and B

Layer 1:

$$\sigma_{I1} := \frac{F}{A} = 0.775 \cdot \text{MPa}$$

Initial stress wave of Rod A and B

$$\sigma_{A1.R} := \frac{\rho_{A2} \cdot c_{A2} - \rho_{A1} \cdot c_{A1}}{\rho_{A2} \cdot c_{A2} + \rho_{A1} \cdot c_{A1}} \cdot \sigma_{I1} = 0.188 \cdot \text{MPa}$$

Reflected stress wave, first layer in Rod A

$$\sigma_{A1.T} := \frac{2 \cdot \rho_{A2} \cdot c_{A2}}{\rho_{A1} \cdot c_{A1} + \rho_{A2} \cdot c_{A2}} \cdot \sigma_{I1} = 0.963 \cdot \text{MPa}$$

Transmitted stress wave, first layer in Rod A

$$\sigma_{A1.T} - \sigma_{A1.R} = 0.775 \cdot \text{MPa}$$

Transmitted stress wave minus reflected stress wave equals to the initial stress wave, meaning that the first layer is in balance

$$U_{PI.A1} := \frac{\sigma_{I1}}{\rho_{A1} \cdot c_{A1}} = 0.088 \frac{\text{m}}{\text{s}}$$

Initial particle velocity, first layer of Rod A

$$U_{PR.A1} := \frac{-\sigma_{A1.R}}{\rho_{A1} \cdot c_{A1}} = -0.021 \frac{\text{m}}{\text{s}}$$

Reflected particle velocity, first layer of Rod A

$$U_{PT.A1} := \frac{\sigma_{A1.T}}{\rho_{A2} \cdot c_{A2}} = 0.066 \frac{\text{m}}{\text{s}}$$

Transmitted particle velocity, first layer of Rod A

$$U_{PT.A1} - U_{PR.A1} = 0.088 \frac{\text{m}}{\text{s}}$$

Transmitted particle velocity minus reflected particle velocity equals to the initial particle velocity, meaning that the first layer is in balance

Layer 2:

$$\sigma_{A2.I} := \sigma_{A1.T} = 0.963 \cdot \text{MPa}$$

Incident stress wave

$$\sigma_{A2.R} := \frac{\rho_{A3} \cdot c_{A1} - \rho_{A2} \cdot c_{A2}}{\rho_{A3} \cdot c_{A1} + \rho_{A2} \cdot c_{A2}} \cdot \sigma_{A2.I} = 0.488 \cdot \text{MPa}$$

Reflected stress wave, second layer in Rod A

$$\sigma_{A2.T} := \frac{2 \cdot \rho_{A3} \cdot c_{A3}}{\rho_{A2} \cdot c_{A2} + \rho_{A3} \cdot c_{A3}} \cdot \sigma_{A2.I} = 1.055 \cdot \text{MPa}$$

Transmitted stress wave, second layer in Rod A

Transmitted stress wave minus reflected

$$\sigma_{A2.T} - \sigma_{A2.R} = 0.568 \cdot \text{MPa}$$

stress wave equals to the incident stress wave, meaning that the second layer is in balance

$$U_{PI.A2} := \frac{\sigma_{A2.I}}{\rho_{A2} \cdot c_{A2}} = 0.066 \frac{\text{m}}{\text{s}}$$

Incident particle velocity, second second of Rod A

$$U_{PR.A2} := \frac{-\sigma_{A2.R}}{\rho_{A2} \cdot c_{A2}} = -0.034 \frac{\text{m}}{\text{s}}$$

Reflected particle velocity, second layer of Rod A

$$U_{PT.A2} := \frac{\sigma_{A2.T}}{\rho_{A3} \cdot c_{A3}} = 0.06 \frac{\text{m}}{\text{s}}$$

Transmitted particle velocity, second layer of Rod A

$$U_{PT.A2} - U_{PR.A2} = 0.094 \frac{\text{m}}{\text{s}}$$

Transmitted particle velocity minus reflected particle velocity equals to the incident particle velocity, meaning that the second layer is in balance

Layer 3:

$$\sigma_{A3.I} := \sigma_{A2.T} = 1.055 \cdot \text{MPa}$$

Incident stress wave

$$\sigma_{A3.R} := \frac{\rho_{A4} \cdot c_{A4} - \rho_{A3} \cdot c_{A3}}{\rho_{A4} \cdot c_{A4} + \rho_{A3} \cdot c_{A3}} \cdot \sigma_{A3.I} = 0.051 \cdot \text{MPa}$$

Reflected stress wave, third layer in Rod A

$$\sigma_{A3.T} := \frac{2 \cdot \rho_{A4} \cdot c_{A4}}{\rho_{A3} \cdot c_{A3} + \rho_{A4} \cdot c_{A4}} \cdot \sigma_{A3.I} = 1.106 \cdot \text{MPa}$$

Transmitted stress wave, third layer in Rod A

$$\sigma_{A3.T} - \sigma_{A3.R} = 1.055 \cdot \text{MPa}$$

Transmitted stress wave minus reflected stress wave equals to the initial stress wave, meaning that the third layer is in balance

$$U_{PI.A3} := \frac{\sigma_{A3.I}}{\rho_{A3} \cdot c_{A3}} = 0.06 \frac{\text{m}}{\text{s}}$$

Incident particle velocity, third layer of Rod A

$$U_{PR.A3} := \frac{-\sigma_{A3.R}}{\rho_{A3} \cdot c_{A3}} = -2.899 \times 10^{-3} \frac{m}{s}$$

Reflected particle velocity, third layer of Rod A

$$U_{PT.A3} := \frac{\sigma_{A3.T}}{\rho_{A4} \cdot c_{A4}} = 0.057 \frac{m}{s}$$

Transmitted particle velocity, third layer of Rod A

$$U_{PT.A3} - U_{PR.A3} = 0.06 \frac{m}{s}$$

Transmitted particle velocity minus reflected particle velocity equals to the incident particle velocity, meaning that the third layer is in balance

Layer 4:

$$\sigma_{A4.I} := \sigma_{A3.T} = 1.106 \cdot \text{MPa}$$

Incident stress wave

$$\sigma_{A4.R} := \frac{\rho_{A5} \cdot c_{A5} - \rho_{A4} \cdot c_{A4}}{\rho_{A5} \cdot c_{A5} + \rho_{A4} \cdot c_{A4}} \cdot \sigma_{A4.I} = 0.023 \cdot \text{MPa}$$

Reflected stress wave, fourth layer in Rod A

$$\sigma_{A4.T} := \frac{2 \cdot \rho_{A5} \cdot c_{A5}}{\rho_{A4} \cdot c_{A4} + \rho_{A5} \cdot c_{A5}} \cdot \sigma_{A4.I} = 1.13 \cdot \text{MPa}$$

Transmitted stress wave, fourth layer in Rod A

$$\sigma_{A4.T} - \sigma_{A4.R} = 1.106 \cdot \text{MPa}$$

Transmitted stress wave minus reflected stress wave equals to the initial stress wave, meaning that the fourth layer is in balance

$$U_{PI.A4} := \frac{\sigma_{A4.I}}{\rho_{A4} \cdot c_{A4}} = 0.057 \frac{m}{s}$$

Incident particle velocity, fourth layer of Rod A

$$U_{PR.A4} := \frac{-\sigma_{A4.R}}{\rho_{A4} \cdot c_{A4}} = -1.203 \times 10^{-3} \frac{m}{s}$$

Reflected particle velocity, fourth layer of Rod A

$$U_{PT.A4} := \frac{\sigma_{A4.T}}{\rho_{A5} \cdot c_{A5}} = 0.056 \frac{m}{s}$$

Transmitted particle velocity, fourth layer of Rod A

$$U_{PT.A4} - U_{PR.A4} = 0.057 \frac{m}{s}$$

Transmitted particle velocity minus reflected particle velocity equals to the incident particle velocity, meaning that the fourth layer is in balance

Layer 5:

$$\sigma_{A5.I} := \sigma_{A4.T} = 1.13 \cdot \text{MPa}$$

Incident stress wave

$$\sigma_{A5.R} := \frac{\rho_{A6} \cdot c_{A6} - \rho_{A5} \cdot c_{A5}}{\rho_{A6} \cdot c_{A6} + \rho_{A5} \cdot c_{A5}} \cdot \sigma_{A5.I} = 0 \cdot \text{MPa}$$

Reflected stress wave, fifth layer in Rod A

$$\sigma_{A5.T} := \frac{2 \cdot \rho_{A6} \cdot c_{A6}}{\rho_{A5} \cdot c_{A5} + \rho_{A6} \cdot c_{A6}} \cdot \sigma_{A5.I} = 1.13 \cdot \text{MPa}$$

Transmitted stress wave, fifth layer in Rod A

$$\sigma_{A5.T} - \sigma_{A5.R} = 1.13 \cdot \text{MPa}$$

Transmitted stress wave minus reflected stress wave equals to the initial stress wave, meaning that the fifth layer is in balance

$$U_{PI.A5} := \frac{\sigma_{A5.I}}{\rho_{A5} \cdot c_{A5}} = 0.056 \frac{m}{s}$$

Incident particle velocity, fifth layer of Rod A

$$U_{PR.A5} := \frac{-\sigma_{A5.R}}{\rho_{A5} \cdot c_{A5}} = 0 \frac{m}{s}$$

Reflected particle velocity, fifth layer of Rod A

$$U_{PT.A5} := \frac{\sigma_{A5.T}}{\rho_{A6} \cdot c_{A6}} = 0.056 \frac{m}{s}$$

Transmitted particle velocity, fifth layer of Rod A

$$U_{PT.A5} - U_{PR.A5} = 0.056 \frac{m}{s}$$

Transmitted particle velocity minus reflected particle velocity equals to the incident particle velocity, meaning that the fifth layer is in balance

Layer 6:

$$\sigma_{A6.I} := \sigma_{A5.T} = 1.13 \cdot \text{MPa}$$

Incident stress wave

$$\sigma_{A6.R} := \frac{\rho_{A7} \cdot c_{A7} - \rho_{A6} \cdot c_{A6}}{\rho_{A7} \cdot c_{A7} + \rho_{A6} \cdot c_{A6}} \cdot \sigma_{A6.I} = -0.024 \cdot \text{MPa}$$

Reflected stress wave, sixth layer in Rod A

$$\sigma_{A6.T} := \frac{2 \cdot \rho_{A7} \cdot c_{A7}}{\rho_{A6} \cdot c_{A6} + \rho_{A7} \cdot c_{A7}} \cdot \sigma_{A6.I} = 1.106 \cdot \text{MPa}$$

Transmitted stress wave, sixth layer in Rod A

$$\sigma_{A6.T} - \sigma_{A6.R} = 1.13 \cdot \text{MPa}$$

Transmitted stress wave minus reflected stress wave equals to the initial stress wave, meaning that the sixth layer is in balance

$$U_{PI.A6} := \frac{\sigma_{A6.I}}{\rho_{A6} \cdot c_{A6}} = 0.056 \frac{\text{m}}{\text{s}}$$

Incident particle velocity, sixth layer of Rod A

$$U_{PR.A6} := \frac{-\sigma_{A6.R}}{\rho_{A6} \cdot c_{A6}} = 1.178 \times 10^{-3} \frac{\text{m}}{\text{s}}$$

Reflected particle velocity, sixth layer of Rod A

$$U_{PT.A6} := \frac{\sigma_{A6.T}}{\rho_{A7} \cdot c_{A7}} = 0.057 \frac{\text{m}}{\text{s}}$$

Transmitted particle velocity, sixth layer of Rod A

$$U_{PT.A6} - U_{PR.A6} = 0.056 \frac{\text{m}}{\text{s}}$$

Transmitted particle velocity minus reflected particle velocity equals to the incident particle velocity, meaning that the sixth layer is in balance

Layer 7:

$$\sigma_{A7.I} := \sigma_{A6.T} = 1.106 \cdot \text{MPa}$$

Incident stress wave

$$\sigma_{A7.R} := \frac{\rho_{A8} \cdot c_{A8} - \rho_{A7} \cdot c_{A7}}{\rho_{A8} \cdot c_{A8} + \rho_{A7} \cdot c_{A7}} \cdot \sigma_{A7.I} = -0.053 \cdot \text{MPa}$$

Reflected stress wave, seventh layer in Rod A

$$\sigma_{A7.T} := \frac{2 \cdot \rho_{A8} \cdot c_{A8}}{\rho_{A7} \cdot c_{A7} + \rho_{A8} \cdot c_{A8}} \cdot \sigma_{A7.I} = 1.052 \cdot \text{MPa}$$

Transmitted stress wave, seventh layer in Rod A

$$\sigma_{A7.T} - \sigma_{A7.R} = 1.106 \cdot \text{MPa}$$

Transmitted stress wave minus reflected stress wave equals to the initial stress wave, meaning that the seventh layer is in balance

$$U_{PI.A7} := \frac{\sigma_{A7.I}}{\rho_{A7} \cdot c_{A7}} = 0.057 \frac{\text{m}}{\text{s}}$$

Incident particle velocity, seventh layer of Rod A

$$U_{PR.A7} := \frac{-\sigma_{A7.R}}{\rho_{A7} \cdot c_{A7}} = 2.758 \times 10^{-3} \frac{\text{m}}{\text{s}}$$

Reflected particle velocity, seventh layer of Rod A

$$U_{PT.A7} := \frac{\sigma_{A7.T}}{\rho_{A8} \cdot c_{A8}} = 0.06 \frac{\text{m}}{\text{s}}$$

Transmitted particle velocity, seventh layer of Rod A

$$U_{PT.A7} - U_{PR.A7} = 0.057 \frac{\text{m}}{\text{s}}$$

Transmitted particle velocity minus reflected particle velocity equals to the incident particle velocity, meaning that the seventh layer is in balance

Layer 8:

$$\sigma_{A8.I} := \sigma_{A7.T} = 1.052 \cdot \text{MPa}$$

Incident stress wave

$$\sigma_{A8.R} := \frac{\rho_{A9} \cdot c_{A9} - \rho_{A8} \cdot c_{A8}}{\rho_{A9} \cdot c_{A9} + \rho_{A8} \cdot c_{A8}} \cdot \sigma_{A8.I} = -0.101 \cdot \text{MPa}$$

Reflected stress wave, eighth layer in Rod A

$$\sigma_{A8.T} := \frac{2 \cdot \rho_{A9} \cdot c_{A9}}{\rho_{A8} \cdot c_{A8} + \rho_{A9} \cdot c_{A9}} \cdot \sigma_{A8.I} = 0.951 \cdot \text{MPa}$$

Transmitted stress wave, eighth layer in Rod A

$$\sigma_{A8.T} - \sigma_{A8.R} = 1.052 \cdot \text{MPa}$$

Transmitted stress wave minus reflected stress wave equals to the initial stress wave, meaning that the eighth layer is in balance

$$U_{PI.A8} := \frac{\sigma_{A8.I}}{\rho_{A8} \cdot c_{A8}} = 0.06 \frac{\text{m}}{\text{s}}$$

Incident particle velocity, eighth layer of Rod A

$$U_{PR.A8} := \frac{-\sigma_{A8.R}}{\rho_{A8} \cdot c_{A8}} = 5.753 \times 10^{-3} \frac{m}{s}$$

Reflected particle velocity, eighth layer of Rod A

$$U_{PT.A8} := \frac{\sigma_{A8.T}}{\rho_{A9} \cdot c_{A9}} = 0.066 \frac{m}{s}$$

Transmitted particle velocity, eighth layer of Rod A

$$U_{PT.A8} - U_{PR.A8} = 0.06 \frac{m}{s}$$

Transmitted particle velocity minus reflected particle velocity equals to the incident particle velocity, meaning that the eighth layer is in balance

Layer 9:

$$\sigma_{A9.I} := \sigma_{A8.T} = 0.951 \cdot \text{MPa}$$

Incident stress wave

$$\sigma_{A9.R} := \frac{\rho_{A10} \cdot c_{A10} - \rho_{A9} \cdot c_{A9}}{\rho_{A10} \cdot c_{A10} + \rho_{A9} \cdot c_{A9}} \cdot \sigma_{A9.I} = -0.23 \cdot \text{MPa}$$

Reflected stress wave, ninth layer in Rod A

$$\sigma_{A9.T} := \frac{2 \cdot \rho_{A10} \cdot c_{A10}}{\rho_{A9} \cdot c_{A9} + \rho_{A10} \cdot c_{A10}} \cdot \sigma_{A9.I} = 0.721 \cdot \text{MPa}$$

Transmitted stress wave, ninth layer in Rod A

$$\sigma_{A9.T} - \sigma_{A9.R} = 0.951 \cdot \text{MPa}$$

Transmitted stress wave minus reflected stress wave equals to the initial stress wave, meaning that the ninth layer is in balance

$$U_{PI.A9} := \frac{\sigma_{A9.I}}{\rho_{A9} \cdot c_{A9}} = 0.066 \frac{m}{s}$$

Incident particle velocity, ninth layer of Rod A

$$U_{PR.A9} := \frac{-\sigma_{A9.R}}{\rho_{A9} \cdot c_{A9}} = 0.016 \frac{m}{s}$$

Reflected particle velocity, ninth layer of Rod A

$$U_{PT.A9} := \frac{\sigma_{A9.T}}{\rho_{A10} \cdot c_{A10}} = 0.081 \frac{m}{s}$$

Transmitted particle velocity, ninth layer of Rod A

$$U_{PT.A9} - U_{PR.A9} = 0.066 \frac{\text{m}}{\text{s}}$$

Transmitted particle velocity minus reflected particle velocity equals to the incident particle velocity, meaning that the ninth layer is in balance

Layer 10:

$$\sigma_{A10.I} := \sigma_{A9.T} = 0.721 \cdot \text{MPa}$$

Incident stress wave

$$\sigma_{A10.R} := \sigma_{A9.T} = 0.721 \cdot \text{MPa}$$

Reflected stress wave, tenth layer in Rod A

No transmitted stress wave in tenth layer

$$\sigma_{A10.I} + \sigma_{A10.R} = 1.442 \cdot \text{MPa}$$

Balance in the layer

$$U_{PI.A10} := \frac{\sigma_{A10.I}}{\rho_{A10} \cdot c_{A10}} = 0.081 \frac{\text{m}}{\text{s}}$$

Incident particle velocity, tenth layer of Rod A

$$U_{PR.A10} := U_{PI.A10} = 0.081 \frac{\text{m}}{\text{s}}$$

Reflected particle velocity, tenth layer of Rod A

No transmitted stress wave in tenth layer

$$U_{PR.A10} - U_{PI.A10} = 0 \frac{\text{m}}{\text{s}}$$

Balance in the layer

Material parameters Rod B

Material parameters is calculated from Mathematica

Young's modulus:

$$E_{B1} := 99.75 \text{ GPa}$$

$$E_{B2} := 89.25 \text{ GPa}$$

$$E_{B3} := 78.75 \text{ GPa}$$

$$E_{B4} := 68.25 \text{ GPa}$$

$$E_{B5} := 57.75 \text{ GPa}$$

$$E_{B6} := 47.25 \text{ GPa}$$

$$E_{B7} := 36.75 \text{ GPa}$$

$$E_{B8} := 26.25 \text{ GPa}$$

$$E_{B9} := 15.75 \text{ GPa}$$

$$E_{B10} := 5.25 \text{ GPa}$$

Density:

$$\rho_{B1} := 785 \frac{\text{kg}}{\text{m}^3}$$

$$\rho_{B2} := 2355 \cdot \frac{\text{kg}}{\text{m}^3}$$

$$\rho_{B3} := 3925 \cdot \frac{\text{kg}}{\text{m}^3}$$

$$\rho_{B4} := 5495 \cdot \frac{\text{kg}}{\text{m}^3}$$

$$\rho_{B5} := 7065 \cdot \frac{\text{kg}}{\text{m}^3}$$

$$\rho_{B6} := 8635 \cdot \frac{\text{kg}}{\text{m}^3}$$

$$\rho_{B7} := 10205 \cdot \frac{\text{kg}}{\text{m}^3}$$

$$\rho_{B8} := 11775 \cdot \frac{\text{kg}}{\text{m}^3}$$

$$\rho_{B9} := 13345 \cdot \frac{\text{kg}}{\text{m}^3}$$

$$\rho_{B10} := 14915 \cdot \frac{\text{kg}}{\text{m}^3}$$

Wave velocity:

$$c_{B1} := \sqrt{\frac{E_{B1}}{\rho_{B1}}} = 1.127 \times 10^4 \frac{\text{m}}{\text{s}}$$

$$c_{B2} := \sqrt{\frac{E_{B2}}{\rho_{B2}}} = 6.156 \times 10^3 \frac{\text{m}}{\text{s}}$$

$$c_{B3} := \sqrt{\frac{E_{B3}}{\rho_{B3}}} = 4.479 \times 10^3 \frac{\text{m}}{\text{s}}$$

$$c_{B4} := \sqrt{\frac{E_{B4}}{\rho_{B4}}} = 3.524 \times 10^3 \frac{\text{m}}{\text{s}}$$

$$c_{B5} := \sqrt{\frac{E_{B5}}{\rho_{B5}}} = 2.859 \times 10^3 \frac{\text{m}}{\text{s}}$$

$$c_{B6} := \sqrt{\frac{E_{B6}}{\rho_{B6}}} = 2.339 \times 10^3 \frac{\text{m}}{\text{s}}$$

$$c_{B7} := \sqrt{\frac{E_{B7}}{\rho_{B7}}} = 1.898 \times 10^3 \frac{\text{m}}{\text{s}}$$

$$c_{B8} := \sqrt{\frac{E_{B8}}{\rho_{B8}}} = 1.493 \times 10^3 \frac{\text{m}}{\text{s}}$$

$$c_{B9} := \sqrt{\frac{E_{B9}}{\rho_{B9}}} = 1.086 \times 10^3 \frac{\text{m}}{\text{s}}$$

$$c_{B10} := \sqrt{\frac{E_{B10}}{\rho_{B10}}} = 593.291 \frac{\text{m}}{\text{s}}$$

Stresses Rod B

Layer 1:

$$\sigma_{B1.I} := \frac{F}{A} = 0.775 \cdot \text{MPa}$$

Initial stress wave of Rod A and B

$$\sigma_{B1.R} := \frac{\rho_{B2} \cdot c_{B2} - \rho_{B1} \cdot c_{B1}}{\rho_{B2} \cdot c_{B2} + \rho_{B1} \cdot c_{B1}} \cdot \sigma_{I1} = 0.188 \cdot \text{MPa}$$

Reflected stress wave, first layer in Rod B

$$\sigma_{B1.T} := \frac{2 \cdot \rho_{B2} \cdot c_{B2}}{\rho_{B1} \cdot c_{B1} + \rho_{B2} \cdot c_{B2}} \cdot \sigma_{I1} = 0.963 \cdot \text{MPa}$$

Transmitted stress wave, first layer in Rod B

$$\sigma_{B1.T} - \sigma_{A1.R} = 0.775 \cdot \text{MPa}$$

Transmitted stress wave minus reflected stress wave equals to the initial stress wave, meaning that the first layer is in balance

$$U_{PI.B1} := \frac{\sigma_{B1.I}}{\rho_{B1} \cdot c_{B1}} = 0.088 \frac{\text{m}}{\text{s}}$$

Initial particle velocity, first layer of Rod B

$$U_{PR.B1} := \frac{-\sigma_{B1.R}}{\rho_{B1} \cdot c_{B1}} = -0.021 \frac{\text{m}}{\text{s}}$$

Reflected particle velocity, first layer of Rod B

$$U_{PT.B1} := \frac{\sigma_{B1.T}}{\rho_{B2} \cdot c_{B2}} = 0.066 \frac{\text{m}}{\text{s}}$$

Transmitted particle velocity, first layer of Rod B

$$U_{PT.B1} - U_{PR.B1} = 0.088 \frac{\text{m}}{\text{s}}$$

Transmitted particle velocity minus reflected particle velocity equals to the initial particle velocity, meaning that the first layer is in balance

Layer 2:

$$\sigma_{B2.I} := \sigma_{B1.T} = 0.963 \cdot \text{MPa} \quad \text{Incident stress wave}$$

$$\sigma_{B2.R} := \frac{\rho_{B3} \cdot c_{B3} - \rho_{B2} \cdot c_{B2}}{\rho_{B3} \cdot c_{B3} + \rho_{B2} \cdot c_{B2}} \cdot \sigma_{B2.I} = 0.093 \cdot \text{MPa} \quad \text{Reflected stress wave, second layer in Rod B}$$

$$\sigma_{B2.T} := \frac{2 \cdot \rho_{B3} \cdot c_{B3}}{\rho_{B2} \cdot c_{B2} + \rho_{B3} \cdot c_{B3}} \cdot \sigma_{B2.I} = 1.055 \cdot \text{MPa} \quad \text{Transmitted stress wave, second layer in Rod B}$$

$$\sigma_{B2.T} - \sigma_{B2.R} = 0.963 \cdot \text{MPa} \quad \text{Transmitted stress wave minus reflected stress wave equals to the initial stress wave, meaning that the second layer is in balance}$$

$$U_{PI.B2} := \frac{\sigma_{B2.I}}{\rho_{B2} \cdot c_{B2}} = 0.066 \frac{\text{m}}{\text{s}} \quad \text{Incident particle velocity, second layer of Rod B}$$

$$U_{PR.B2} := \frac{-\sigma_{B2.R}}{\rho_{B2} \cdot c_{B2}} = -6.383 \times 10^{-3} \frac{\text{m}}{\text{s}} \quad \text{Reflected particle velocity, second layer of Rod B}$$

$$U_{PT.B2} := \frac{\sigma_{B2.T}}{\rho_{B3} \cdot c_{B3}} = 0.06 \frac{\text{m}}{\text{s}} \quad \text{Transmitted particle velocity, second layer of Rod B}$$

$$U_{PT.B2} - U_{PR.B2} = 0.066 \frac{\text{m}}{\text{s}} \quad \text{Transmitted particle velocity minus reflected particle velocity equals to the incident particle velocity, meaning that the second layer is in balance}$$

Layer 3:

$$\sigma_{B3.I} := \sigma_{B2.T} = 1.055 \cdot \text{MPa} \quad \text{Incident stress wave}$$

$$\sigma_{B3.R} := \frac{\rho_{B4} \cdot c_{B4} - \rho_{B3} \cdot c_{B3}}{\rho_{B4} \cdot c_{B4} + \rho_{B3} \cdot c_{B3}} \cdot \sigma_{B3.I} = 0.051 \cdot \text{MPa} \quad \text{Reflected stress wave, third layer in Rod B}$$

$$\sigma_{B3.T} := \frac{2 \cdot \rho_{B4} \cdot c_{B4}}{\rho_{B3} \cdot c_{B3} + \rho_{B4} \cdot c_{B4}} \cdot \sigma_{B3.I} = 1.106 \cdot \text{MPa}$$

Transmitted stress wave, third layer in Rod B

$$\sigma_{B3.T} - \sigma_{B3.R} = 1.055 \cdot \text{MPa}$$

Transmitted stress wave minus reflected stress wave equals to the initial stress wave, meaning that the third layer is in balance

$$U_{PI.B3} := \frac{\sigma_{B3.I}}{\rho_{B3} \cdot c_{B3}} = 0.06 \frac{\text{m}}{\text{s}}$$

Incident particle velocity, third layer of Rod B

$$U_{PR.B3} := \frac{-\sigma_{B3.R}}{\rho_{B3} \cdot c_{B3}} = -2.899 \times 10^{-3} \frac{\text{m}}{\text{s}}$$

Reflected particle velocity, third layer of Rod B

$$U_{PT.B3} := \frac{\sigma_{B3.T}}{\rho_{B4} \cdot c_{B4}} = 0.057 \frac{\text{m}}{\text{s}}$$

Transmitted particle velocity, third layer of Rod B

$$U_{PT.B3} - U_{PR.B3} = 0.06 \frac{\text{m}}{\text{s}}$$

Transmitted particle velocity minus reflected particle velocity equals to the incident particle velocity, meaning that the third layer is in balance

Layer 4:

$$\sigma_{B4.I} := \sigma_{B3.T} = 1.106 \cdot \text{MPa}$$

Incident stress wave

$$\sigma_{B4.R} := \frac{\rho_{B5} \cdot c_{B5} - \rho_{B4} \cdot c_{B4}}{\rho_{B5} \cdot c_{B5} + \rho_{B4} \cdot c_{B4}} \cdot \sigma_{B4.I} = 0.023 \cdot \text{MPa}$$

Reflected stress wave, fourth layer in Rod B

$$\sigma_{B4.T} := \frac{2 \cdot \rho_{B5} \cdot c_{B5}}{\rho_{B4} \cdot c_{B4} + \rho_{B5} \cdot c_{B5}} \cdot \sigma_{B4.I} = 1.13 \cdot \text{MPa}$$

Transmitted stress wave, fourth layer in Rod B

$$\sigma_{B4.T} - \sigma_{B4.R} = 1.106 \cdot \text{MPa}$$

Transmitted stress wave minus reflected stress wave equals to the initial stress wave, meaning that the fourth layer is in balance

$$U_{PI.B4} := \frac{\sigma_{B4.I}}{\rho_{B4} \cdot c_{B4}} = 0.057 \frac{\text{m}}{\text{s}}$$

Incident particle velocity, fourth layer of Rod B

$$U_{PR.B4} := \frac{-\sigma_{B4.R}}{\rho_{B4} \cdot c_{B4}} = -1.203 \times 10^{-3} \frac{m}{s}$$

Reflected particle velocity, fourth layer of Rod B

$$U_{PT.B4} := \frac{\sigma_{B4.T}}{\rho_{B5} \cdot c_{B5}} = 0.056 \frac{m}{s}$$

Transmitted particle velocity, fourth layer of Rod B

$$U_{PT.B4} - U_{PR.B4} = 0.057 \frac{m}{s}$$

Transmitted particle velocity minus reflected particle velocity equals to the incident particle velocity, meaning that the fourth layer is in balance

Layer 5:

$$\sigma_{B5.I} := \sigma_{B4.T} = 1.13 \cdot \text{MPa}$$

Incident stress wave

$$\sigma_{B5.R} := \frac{\rho_{B6} \cdot c_{B6} - \rho_{B5} \cdot c_{B5}}{\rho_{B6} \cdot c_{B6} + \rho_{B5} \cdot c_{B5}} \cdot \sigma_{B5.I} = 0 \cdot \text{MPa}$$

Reflected stress wave, fifth layer in Rod B

$$\sigma_{B5.T} := \frac{2 \cdot \rho_{B6} \cdot c_{B6}}{\rho_{B5} \cdot c_{B5} + \rho_{B6} \cdot c_{B6}} \cdot \sigma_{B5.I} = 1.13 \cdot \text{MPa}$$

Transmitted stress wave, fifth layer in Rod B

$$\sigma_{B5.T} - \sigma_{B5.R} = 1.13 \cdot \text{MPa}$$

Transmitted stress wave minus reflected stress wave equals to the initial stress wave, meaning that the fifth layer is in balance

$$U_{PI.B5} := \frac{\sigma_{B5.I}}{\rho_{B5} \cdot c_{B5}} = 0.056 \frac{m}{s}$$

Incident particle velocity, fifth layer of Rod B

$$U_{PR.B5} := \frac{-\sigma_{B5.R}}{\rho_{B5} \cdot c_{B5}} = 0 \frac{m}{s}$$

Reflected particle velocity, fifth layer of Rod B

$$U_{PT.B5} := \frac{\sigma_{B5.T}}{\rho_{B6} \cdot c_{B6}} = 0.056 \frac{m}{s}$$

Transmitted particle velocity, fifth layer of Rod B

$$U_{PT.B5} - U_{PR.B5} = 0.056 \frac{m}{s}$$

Transmitted particle velocity minus reflected particle velocity equals to the incident particle velocity, meaning that the fifth layer is in balance

Layer 6:

$$\sigma_{B6.I} := \sigma_{B5.T} = 1.13 \cdot \text{MPa} \quad \text{Incident stress wave}$$

$$\sigma_{B6.R} := \frac{\rho_{B7} \cdot c_{B7} - \rho_{B6} \cdot c_{B6}}{\rho_{B7} \cdot c_{B7} + \rho_{B6} \cdot c_{B6}} \cdot \sigma_{B6.I} = -0.024 \cdot \text{MPa} \quad \text{Reflected stress wave, sixth layer in Rod B}$$

$$\sigma_{B6.T} := \frac{2 \cdot \rho_{B7} \cdot c_{B7}}{\rho_{B6} \cdot c_{B6} + \rho_{B7} \cdot c_{B7}} \cdot \sigma_{B6.I} = 1.106 \cdot \text{MPa} \quad \text{Transmitted stress wave, sixth layer in Rod B}$$

$$\sigma_{B6.T} - \sigma_{B6.R} = 1.13 \cdot \text{MPa} \quad \text{Transmitted stress wave minus reflected stress wave equals to the initial stress wave, meaning that the sixth layer is in balance}$$

$$U_{PI.B6} := \frac{\sigma_{B6.I}}{\rho_{B6} \cdot c_{B6}} = 0.056 \frac{\text{m}}{\text{s}} \quad \text{Incident particle velocity, sixth layer of Rod B}$$

$$U_{PR.B6} := \frac{-\sigma_{B6.R}}{\rho_{B6} \cdot c_{B6}} = 1.178 \times 10^{-3} \frac{\text{m}}{\text{s}} \quad \text{Reflected particle velocity, sixth layer of Rod B}$$

$$U_{PT.B6} := \frac{\sigma_{B6.T}}{\rho_{B7} \cdot c_{B7}} = 0.057 \frac{\text{m}}{\text{s}} \quad \text{Transmitted particle velocity, sixth layer of Rod B}$$

$$U_{PT.B6} - U_{PR.B6} = 0.056 \frac{\text{m}}{\text{s}} \quad \text{Transmitted particle velocity minus reflected particle velocity equals to the incident particle velocity, meaning that the sixth layer is in balance}$$

Layer 7:

$$\sigma_{B7.I} := \sigma_{B6.T} = 1.106 \cdot \text{MPa} \quad \text{Incident stress wave}$$

$$\sigma_{B7.R} := \frac{\rho_{B8} \cdot c_{B8} - \rho_{B7} \cdot c_{B7}}{\rho_{B8} \cdot c_{B8} + \rho_{B7} \cdot c_{B7}} \cdot \sigma_{B7.I} = -0.053 \cdot \text{MPa} \quad \text{Reflected stress wave, seventh layer in Rod B}$$

$$\sigma_{B7.T} := \frac{2 \cdot \rho_{B8} \cdot c_{B8}}{\rho_{B7} \cdot c_{B7} + \rho_{B8} \cdot c_{B8}} \cdot \sigma_{B7.I} = 1.052 \cdot \text{MPa}$$

Transmitted stress wave, seventh layer in Rod B

$$\sigma_{B7.T} - \sigma_{B7.R} = 1.106 \cdot \text{MPa}$$

Transmitted stress wave minus reflected stress wave equals to the initial stress wave, meaning that the seventh layer is in balance

$$U_{PI.B7} := \frac{\sigma_{B7.I}}{\rho_{B7} \cdot c_{B7}} = 0.057 \frac{\text{m}}{\text{s}}$$

Incident particle velocity, seventh layer of Rod B

$$U_{PR.B7} := \frac{-\sigma_{B7.R}}{\rho_{B7} \cdot c_{B7}} = 2.758 \times 10^{-3} \frac{\text{m}}{\text{s}}$$

Reflected particle velocity, seventh layer of Rod B

$$U_{PT.B7} := \frac{\sigma_{B7.T}}{\rho_{B8} \cdot c_{B8}} = 0.06 \frac{\text{m}}{\text{s}}$$

Transmitted particle velocity, seventh layer of Rod B

$$U_{PT.B7} - U_{PR.B7} = 0.057 \frac{\text{m}}{\text{s}}$$

Transmitted particle velocity minus reflected particle velocity equals to the incident particle velocity, meaning that the seventh layer is in balance

Layer 8:

$$\sigma_{B8.I} := \sigma_{B7.T} = 1.052 \cdot \text{MPa}$$

Incident stress wave

$$\sigma_{B8.R} := \frac{\rho_{B9} \cdot c_{B9} - \rho_{B8} \cdot c_{B8}}{\rho_{B9} \cdot c_{B9} + \rho_{B8} \cdot c_{B8}} \cdot \sigma_{B8.I} = -0.101 \cdot \text{MPa}$$

Reflected stress wave, eighth layer in Rod B

$$\sigma_{B8.T} := \frac{2 \cdot \rho_{B9} \cdot c_{B9}}{\rho_{B8} \cdot c_{B8} + \rho_{B9} \cdot c_{B9}} \cdot \sigma_{B8.I} = 0.951 \cdot \text{MPa}$$

Transmitted stress wave, eighth layer in Rod B

$$\sigma_{B8.T} - \sigma_{B8.R} = 1.052 \cdot \text{MPa}$$

Transmitted stress wave minus reflected stress wave equals to the initial stress wave, meaning that the eighth layer is in balance

$$U_{PI.B8} := \frac{\sigma_{B8.I}}{\rho_{B8} \cdot c_{B8}} = 0.06 \frac{m}{s}$$

Incident particle velocity, eighth layer of Rod B

$$U_{PR.B8} := \frac{-\sigma_{B8.R}}{\rho_{B8} \cdot c_{B8}} = 5.753 \times 10^{-3} \frac{m}{s}$$

Reflected particle velocity, eighth layer of Rod B

$$U_{PT.B8} := \frac{\sigma_{B8.T}}{\rho_{B9} \cdot c_{B9}} = 0.066 \frac{m}{s}$$

Transmitted particle velocity, eighth layer of Rod B

$$U_{PT.B8} - U_{PR.B8} = 0.06 \frac{m}{s}$$

Transmitted particle velocity minus reflected particle velocity equals to the incident particle velocity, meaning that the eighth layer is in balance

Layer 9:

$$\sigma_{B9.I} := \sigma_{B8.T} = 0.951 \cdot \text{MPa}$$

Incident stress wave

$$\sigma_{B9.R} := \frac{\rho_{B10} \cdot c_{B10} - \rho_{B9} \cdot c_{B9}}{\rho_{B10} \cdot c_{B10} + \rho_{B9} \cdot c_{B9}} \cdot \sigma_{B9.I} = -0.23 \cdot \text{MPa}$$

Reflected stress wave, ninth layer in Rod B

$$\sigma_{B9.T} := \frac{2 \cdot \rho_{B10} \cdot c_{B10}}{\rho_{B9} \cdot c_{B9} + \rho_{B10} \cdot c_{B10}} \cdot \sigma_{B9.I} = 0.721 \cdot \text{MPa}$$

Transmitted stress wave, ninth layer in Rod B

$$\sigma_{B9.T} - \sigma_{B9.R} = 0.951 \cdot \text{MPa}$$

Transmitted stress wave minus reflected stress wave equals to the initial stress wave, meaning that the ninth layer is in balance

$$U_{PI.B9} := \frac{\sigma_{B9.I}}{\rho_{B9} \cdot c_{B9}} = 0.066 \frac{m}{s}$$

Incident particle velocity, ninth layer of Rod B

$$U_{PR.B9} := \frac{-\sigma_{B9.R}}{\rho_{B9} \cdot c_{B9}} = 0.016 \frac{m}{s}$$

Reflected particle velocity, ninth layer of Rod B

$$U_{PT.B9} := \frac{\sigma_{B9.T}}{\rho_{B10} \cdot c_{B10}} = 0.081 \frac{m}{s}$$

Transmitted particle velocity, ninth layer of Rod B

$$U_{PT.B9} - U_{PR.B9} = 0.066 \frac{\text{m}}{\text{s}}$$

Transmitted particle velocity minus reflected particle velocity equals to the incident particle velocity, meaning that the ninth layer is in balance

Layer 10:

$$\sigma_{B10.I} := \sigma_{B9.T} = 0.721 \cdot \text{MPa}$$

Incident stress wave

$$\sigma_{B10.R} := \sigma_{B9.T} = 0.721 \cdot \text{MPa}$$

Reflected stress wave, tenth layer in Rod B

No transmitted stress wave in tenth layer

$$\sigma_{B10.I} + \sigma_{B10.R} = 1.442 \cdot \text{MPa}$$

Balance in the layer

$$U_{PI.B10} := \frac{\sigma_{B10.I}}{\rho_{B10} \cdot c_{B10}} = 0.081 \frac{\text{m}}{\text{s}}$$

Incident particle velocity, tenth layer of Rod B

$$U_{PR.B10} := U_{PI.B10} = 0.081 \frac{\text{m}}{\text{s}}$$

Reflected particle velocity, tenth layer of Rod B

No transmitted stress wave in tenth layer

$$U_{PR.B10} - U_{PI.B10} = 0 \frac{\text{m}}{\text{s}}$$

Balance in the layer

C Material properties and dynamic response calculations, Case study 3

Calculation of material parameters for case studie three and plots

Defines the material functions for Young' s modulus and the density

```
ClearAll[E0, ρ0]; E0 = 210. × 109; ρ0 = 7850.;
```

$$\mathbf{Emod}[\mathbf{x}_] = \mathbf{E0} \left(\frac{1}{10} \mathbf{x} + (1 - \mathbf{x}) \right)$$

$$2.1 \times 10^{11} \left(1 - \frac{9 \mathbf{x}}{10} \right)$$

$$\rho[\mathbf{x}_] = \rho0 \left(\frac{1}{10} \mathbf{x} + (1 - \mathbf{x}) \right)$$

$$7850. \left(1 - \frac{9 \mathbf{x}}{10} \right)$$

Defines the psi functions and calculating beta(x)

$$\mathbf{poly2}[\mathbf{x}_] = \frac{0.5}{1} \mathbf{x}^2$$

```
ψ = poly2
```

```
poly2
```

```
invψ = invpoly2
```

```
invpoly2
```

$$\mathbf{Solve} \left[\frac{0.5}{1} \mathbf{x}^2 == \mathbf{y}, \mathbf{x} \right]$$

$$\left\{ \left\{ \mathbf{x} \rightarrow -1.41421 \sqrt{\mathbf{y}} \right\}, \left\{ \mathbf{x} \rightarrow 1.41421 \sqrt{\mathbf{y}} \right\} \right\}$$

$$\mathbf{invpoly2}[\mathbf{x}_] := 1.4142135623730951 \sqrt{\mathbf{x}}$$

$$\beta[\mathbf{x}_] := \mathbf{poly2}'[\mathbf{invpoly2}[\mathbf{x}]]$$

Plots the different material curves for the material properties and the wave velocity

```
Ehat = Plot[Emod[invψ[x]] β[x], {x, 0, 0.5},
  PlotStyle -> GrayLevel[0], AxesOrigin -> {0, 0}]
```

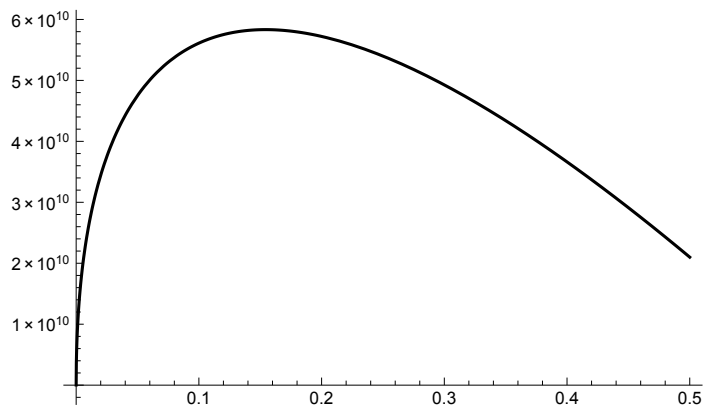

```
rhohat =
```

```
Plot[ $\frac{\rho[\text{inv}\psi[x]]}{\beta[x]}$ , {x, 0, 0.5}, PlotStyle -> GrayLevel[0], AxesOrigin -> {0, 0}]
```

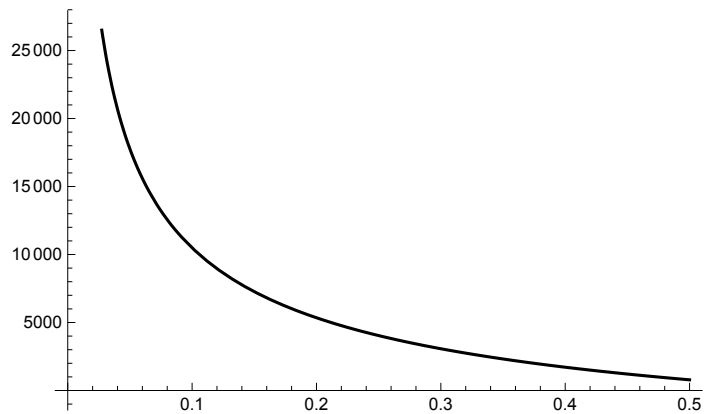

```
emod = Plot[Emod[x], {x, 0, 1}, PlotStyle -> GrayLevel[0],
  AxesOrigin -> {0, 0}, AxesLabel -> {m, Pa}, LabelStyle -> {Black}]
```

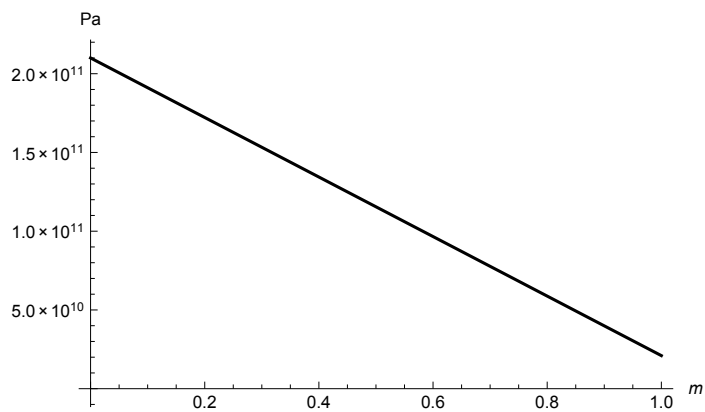

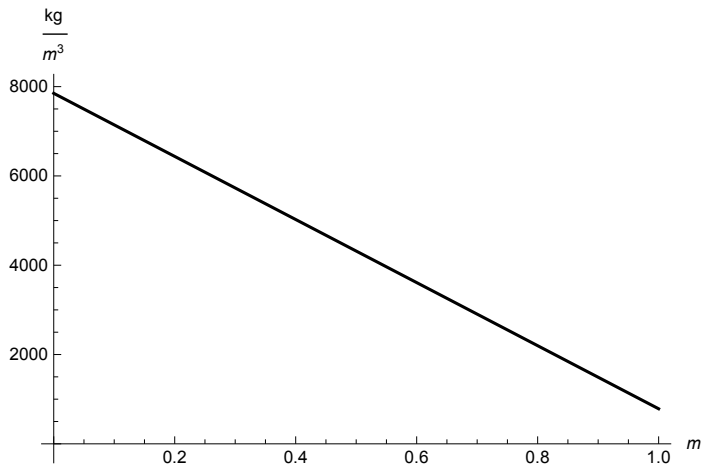

```
rho = Plot[ρ[x], {x, 0, 1}, PlotStyle → GrayLevel[0],
  AxesOrigin → {0, 0}, AxesLabel → {m, kg / m^3}, LabelStyle → {Black}]
```

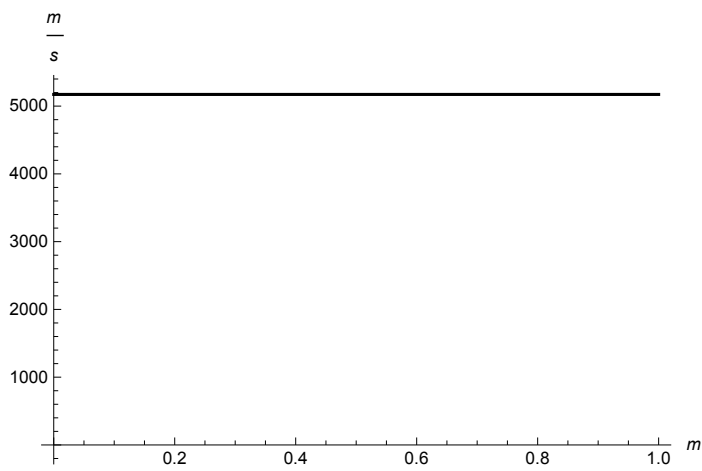

```
vel1 = Plot[√(Emod[x] / ρ[x]), {x, 0, 1}, PlotStyle → GrayLevel[0],
  AxesOrigin → {0, 0}, AxesLabel → {m, m / s}, LabelStyle → {Black}]
```

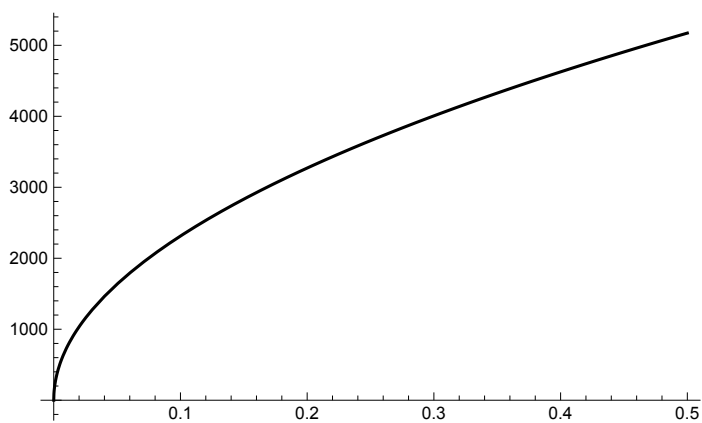

```
vel2 = Plot[√(Emod[invψ[x]] β[x] / (ρ[invψ[x]] β[x])),
  {x, 0, 0.5}, PlotStyle → GrayLevel[0], AxesOrigin → {0, 0}]
```



```
Plot[β[x], {x, 0, 1}, AxesOrigin -> {0, 0}]
```

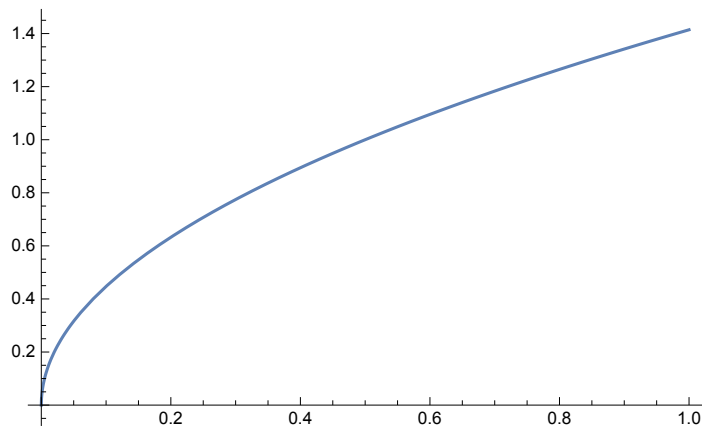

Calculating the material properties from the curves for the transformed and original rods and where the reflections occur

```
MatrixForm[Table[
  {x, x + 0.05, Emod[x], ρ[x], Emod[x] ρ[x], ψ[x + 0.05]}, {x, 0.05, 1 - 0.05, 0.1}]]
```

0.05	0.1	2.0055×10^{11}	7496.75	1.50347×10^{15}	0.005
0.15	0.2	1.8165×10^{11}	6790.25	1.23345×10^{15}	0.02
0.25	0.3	1.6275×10^{11}	6083.75	9.9013×10^{14}	0.045
0.35	0.4	1.4385×10^{11}	5377.25	7.73517×10^{14}	0.08
0.45	0.5	1.2495×10^{11}	4670.75	5.8361×10^{14}	0.125
0.55	0.6	1.0605×10^{11}	3964.25	4.20409×10^{14}	0.18
0.65	0.7	8.715×10^{10}	3257.75	2.83913×10^{14}	0.245
0.75	0.8	6.825×10^{10}	2551.25	1.74123×10^{14}	0.32
0.85	0.9	4.935×10^{10}	1844.75	9.10384×10^{13}	0.405
0.95	1.	3.045×10^{10}	1138.25	3.46597×10^{13}	0.5

```
MatrixForm[Table[{x, ψ[x + 0.05], β[ψ[x]] Emod[x],
  ρ[x] / β[ψ[x]], β[ψ[x]] Emod[x] ρ[x] / β[ψ[x]]}, {x, 0.05, 1 - 0.05, 0.1}]]
```

0.05	0.005	1.00275×10^{10}	149935.	1.50347×10^{15}
0.15	0.02	2.72475×10^{10}	45268.3	1.23345×10^{15}
0.25	0.045	4.06875×10^{10}	24335.	9.9013×10^{14}
0.35	0.08	5.03475×10^{10}	15363.6	7.73517×10^{14}
0.45	0.125	5.62275×10^{10}	10379.4	5.8361×10^{14}
0.55	0.18	5.83275×10^{10}	7207.73	4.20409×10^{14}
0.65	0.245	5.66475×10^{10}	5011.92	2.83913×10^{14}
0.75	0.32	5.11875×10^{10}	3401.67	1.74123×10^{14}
0.85	0.405	4.19475×10^{10}	2170.29	9.10384×10^{13}
0.95	0.5	2.89275×10^{10}	1198.16	3.46597×10^{13}

```
Emoduler = Show[emod, Ehat]
```

Plotting the final plots which shows the transformed and original values for Young's modulus the density and the wave velocity

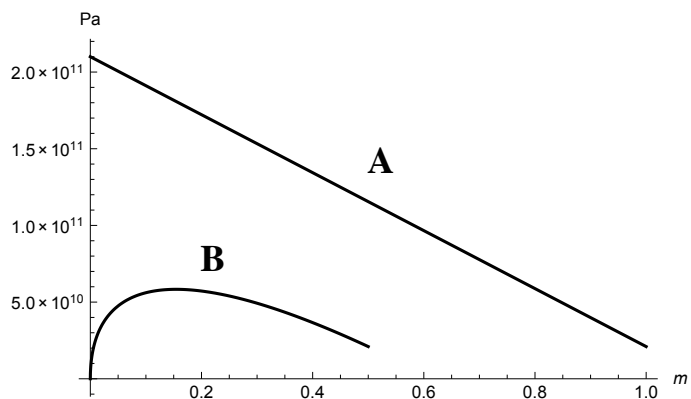

`densitet = Show[rho, rhohat]`

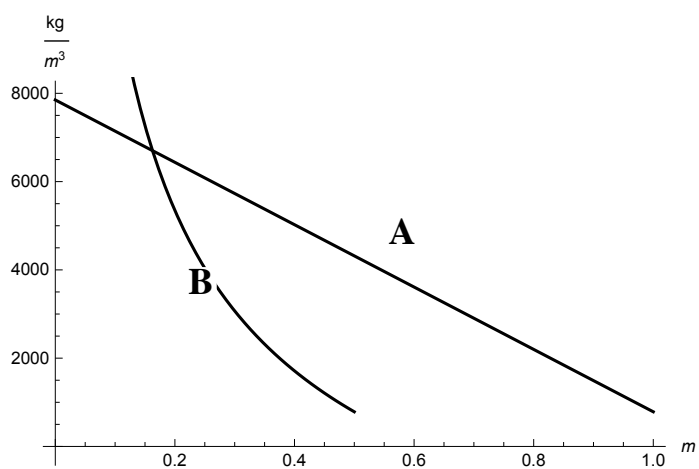

`velocity = Show[vel1, vel2]`

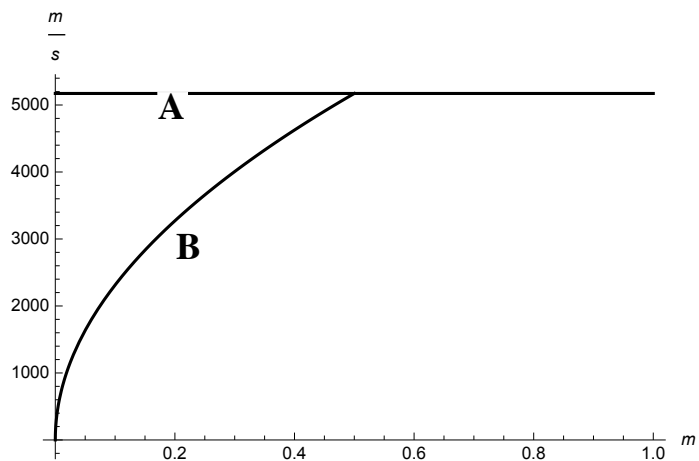

Transformation with x²-function, Case Study 3

Following calculations are made with the theory of elastic wave propagation between different materials. This is done in order to compare two Rods (A and B) with different lengths and material parameters. Stresses and particle velocity for incident, reflected and transmitted waves will be determine and presented below.

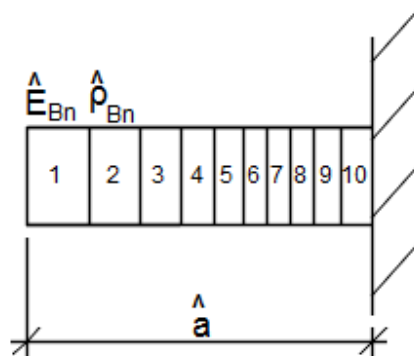
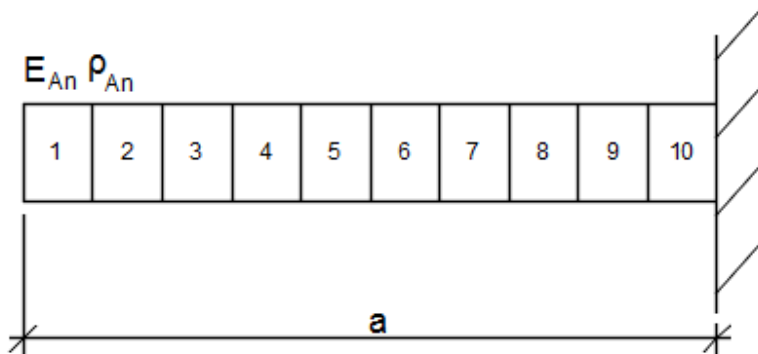

Material parameters Rod A

Material parameters has been calculated in mathematica

Young's modulus: Density:

$$E_{A1} := 2.0055 \cdot 10^{11} \cdot \text{Pa} \quad \rho_{A1} := 7.4968 \cdot 10^3 \cdot \frac{\text{kg}}{\text{m}^3}$$

$$E_{A2} := 1.8165 \cdot 10^{11} \cdot \text{Pa} \quad \rho_{A2} := 6.7903 \cdot 10^3 \cdot \frac{\text{kg}}{\text{m}^3}$$

$$\begin{aligned}
E_{A3} &:= 1.6275 \cdot 10^{11} \cdot \text{Pa} & \rho_{A3} &:= 6.0838 \cdot 10^3 \cdot \frac{\text{kg}}{\text{m}^3} \\
E_{A4} &:= 1.4385 \cdot 10^{11} \cdot \text{Pa} & \rho_{A4} &:= 5.3773 \cdot 10^3 \cdot \frac{\text{kg}}{\text{m}^3} \\
E_{A5} &:= 1.2495 \cdot 10^{11} \cdot \text{Pa} & \rho_{A5} &:= 4.6708 \cdot 10^3 \cdot \frac{\text{kg}}{\text{m}^3} \\
E_{A6} &:= 1.0605 \cdot 10^{11} \cdot \text{Pa} & \rho_{A6} &:= 3.9643 \cdot 10^3 \cdot \frac{\text{kg}}{\text{m}^3} \\
E_{A7} &:= 8.7150 \cdot 10^{10} \cdot \text{Pa} & \rho_{A7} &:= 3.2578 \cdot 10^3 \cdot \frac{\text{kg}}{\text{m}^3} \\
E_{A8} &:= 6.8250 \cdot 10^{10} \cdot \text{Pa} & \rho_{A8} &:= 2.5513 \cdot 10^3 \cdot \frac{\text{kg}}{\text{m}^3} \\
E_{A9} &:= 4.9350 \cdot 10^{10} \cdot \text{Pa} & \rho_{A9} &:= 1.8447 \cdot 10^3 \cdot \frac{\text{kg}}{\text{m}^3} \\
E_{A10} &:= 3.0450 \cdot 10^{10} \cdot \text{Pa} & \rho_{A10} &:= 1.1382 \cdot 10^3 \cdot \frac{\text{kg}}{\text{m}^3}
\end{aligned}$$

Wave Velocity:

$$c_A := \sqrt{\frac{E_{A1}}{\rho_{A1}}} = 5.172 \times 10^3 \frac{\text{m}}{\text{s}}$$

Same Wave velocity for all materials in rod A

Stresses in Rod A

$$F := 500\text{N}$$

Force at the left end of the Rod A and B

$$A := 6.450 \cdot 10^{-4} \text{m}^2$$

Cross section area of Rod A and B

Layer 1:

$$\sigma_{I1} := \frac{F}{A} = 0.775 \cdot \text{MPa}$$

Initial stress wave of Rod A and B

$$\sigma_{A1.R} := \frac{\rho_{A2} \cdot c_A - \rho_{A1} \cdot c_A}{\rho_{A2} \cdot c_A + \rho_{A1} \cdot c_A} \cdot \sigma_{I1} = -0.038 \cdot \text{MPa}$$

Reflected stress wave, first layer in Rod A

$$\sigma_{A1.T} := \frac{2 \cdot \rho_{A2} \cdot c_A}{\rho_{A1} \cdot c_A + \rho_{A2} \cdot c_A} \cdot \sigma_{I1} = 0.737 \cdot \text{MPa}$$

Transmitted stress wave, first layer in Rod A

$$\sigma_{A1.T} - \sigma_{A1.R} = 0.775 \cdot \text{MPa}$$

Transmitted stress wave minus reflected stress wave equals to the initial stress wave, meaning that the first layer is in balance

$$U_{PI.A1} := \frac{\sigma_{I1}}{\rho_{A1} \cdot c_A} = 0.02 \frac{\text{m}}{\text{s}}$$

Initial particle velocity, first layer of Rod A

$$U_{PR.A1} := \frac{-\sigma_{A1.R}}{\rho_{A1} \cdot c_A} = 9.886 \times 10^{-4} \frac{\text{m}}{\text{s}}$$

Reflected particle velocity, first layer of Rod A

$$U_{PT.A1} := \frac{\sigma_{A1.T}}{\rho_{A2} \cdot c_A} = 0.021 \frac{\text{m}}{\text{s}}$$

Transmitted particle velocity, first layer of Rod A

$$U_{PT.A1} - U_{PR.A1} = 0.02 \frac{\text{m}}{\text{s}}$$

Transmitted particle velocity minus reflected particle velocity equals to the initial particle velocity, meaning that the first layer is in balance

Layer 2:

$$\sigma_{A2.I} := \sigma_{A1.T} = 0.737 \cdot \text{MPa}$$

Incident stress wave

$$\sigma_{A2.R} := \frac{\rho_{A3} \cdot c_A - \rho_{A2} \cdot c_A}{\rho_{A3} \cdot c_A + \rho_{A2} \cdot c_A} \cdot \sigma_{A2.I} = -0.04 \cdot \text{MPa}$$

Reflected stress wave, second layer in Rod A

$$\sigma_{A2.T} := \frac{2 \cdot \rho_{A3} \cdot c_A}{\rho_{A2} \cdot c_A + \rho_{A3} \cdot c_A} \cdot \sigma_{A2.I} = 0.696 \cdot \text{MPa}$$

Transmitted stress wave, second layer in Rod A

$$\sigma_{A2.T} - \sigma_{A2.R} = 0.737 \cdot \text{MPa}$$

Transmitted stress wave minus reflected stress wave equals to the incident stress wave, meaning that the second layer is in balance

$$U_{PI.A2} := \frac{\sigma_{A2.I}}{\rho_{A2} \cdot c_A} = 0.021 \frac{\text{m}}{\text{s}}$$

Incident particle velocity, second second of Rod A

$$U_{PR.A2} := \frac{-\sigma_{A2.R}}{\rho_{A2} \cdot c_A} = 1.151 \times 10^{-3} \frac{\text{m}}{\text{s}}$$

Reflected particle velocity, second layer of Rod A

$$U_{PT.A2} := \frac{\sigma_{A2.T}}{\rho_{A3} \cdot c_A} = 0.022 \frac{\text{m}}{\text{s}}$$

Transmitted particle velocity, second layer of Rod A

$$U_{PT.A2} - U_{PR.A2} = 0.021 \frac{\text{m}}{\text{s}}$$

Transmitted particle velocity minus reflected particle velocity equals to the incident particle velocity, meaning that the second layer is in balance

Layer 3:

$$\sigma_{A3.I} := \sigma_{A2.T} = 0.696 \cdot \text{MPa}$$

Incident stress wave

$$\sigma_{A3.R} := \frac{\rho_{A4} \cdot c_A - \rho_{A3} \cdot c_A}{\rho_{A4} \cdot c_A + \rho_{A3} \cdot c_A} \cdot \sigma_{A3.I} = -0.043 \cdot \text{MPa}$$

Reflected stress wave, third layer in Rod A

$$\sigma_{A3.T} := \frac{2 \cdot \rho_{A4} \cdot c_A}{\rho_{A3} \cdot c_A + \rho_{A4} \cdot c_A} \cdot \sigma_{A3.I} = 0.653 \cdot \text{MPa}$$

Transmitted stress wave, third layer in Rod A

$$\sigma_{A3.T} - \sigma_{A3.R} = 0.696 \cdot \text{MPa}$$

Transmitted stress wave minus reflected stress wave equals to the initial stress wave, meaning that the third layer is in balance

$$U_{PI.A3} := \frac{\sigma_{A3.I}}{\rho_{A3} \cdot c_A} = 0.022 \frac{\text{m}}{\text{s}}$$

Incident particle velocity, third layer of Rod A

$$U_{PR.A3} := \frac{-\sigma_{A3.R}}{\rho_{A3} \cdot c_A} = 1.364 \times 10^{-3} \frac{m}{s}$$

Reflected particle velocity, third layer of Rod A

$$U_{PT.A3} := \frac{\sigma_{A3.T}}{\rho_{A4} \cdot c_A} = 0.023 \frac{m}{s}$$

Transmitted particle velocity, third layer of Rod A

$$U_{PT.A3} - U_{PR.A3} = 0.022 \frac{m}{s}$$

Transmitted particle velocity minus reflected particle velocity equals to the incident particle velocity, meaning that the third layer is in balance

Layer 4:

$$\sigma_{A4.I} := \sigma_{A3.T} = 0.653 \cdot \text{MPa}$$

Incident stress wave

$$\sigma_{A4.R} := \frac{\rho_{A5} \cdot c_A - \rho_{A4} \cdot c_A}{\rho_{A5} \cdot c_A + \rho_{A4} \cdot c_A} \cdot \sigma_{A4.I} = -0.046 \cdot \text{MPa}$$

Reflected stress wave, fourth layer in Rod A

$$\sigma_{A4.T} := \frac{2 \cdot \rho_{A5} \cdot c_A}{\rho_{A4} \cdot c_A + \rho_{A5} \cdot c_A} \cdot \sigma_{A4.I} = 0.608 \cdot \text{MPa}$$

Transmitted stress wave, fourth layer in Rod A

$$\sigma_{A4.T} - \sigma_{A4.R} = 0.653 \cdot \text{MPa}$$

Transmitted stress wave minus reflected stress wave equals to the initial stress wave, meaning that the fourth layer is in balance

$$U_{PI.A4} := \frac{\sigma_{A4.I}}{\rho_{A4} \cdot c_A} = 0.023 \frac{m}{s}$$

Incident particle velocity, fourth layer of Rod A

$$U_{PR.A4} := \frac{-\sigma_{A4.R}}{\rho_{A4} \cdot c_A} = 1.652 \times 10^{-3} \frac{m}{s}$$

Reflected particle velocity, fourth layer of Rod A

$$U_{PT.A4} := \frac{\sigma_{A4.T}}{\rho_{A5} \cdot c_A} = 0.025 \frac{m}{s}$$

Transmitted particle velocity, fourth layer of Rod A

$$U_{PT.A4} - U_{PR.A4} = 0.023 \frac{m}{s}$$

Transmitted particle velocity minus reflected particle velocity equals to the incident particle velocity, meaning that the fourth layer is in balance

Layer 5:

$$\sigma_{A5.I} := \sigma_{A4.T} = 0.608 \cdot \text{MPa}$$

Incident stress wave

$$\sigma_{A5.R} := \frac{\rho_{A6} \cdot c_A - \rho_{A5} \cdot c_A}{\rho_{A6} \cdot c_A + \rho_{A5} \cdot c_A} \cdot \sigma_{A5.I} = -0.05 \cdot \text{MPa}$$

Reflected stress wave, fifth layer in Rod A

$$\sigma_{A5.T} := \frac{2 \cdot \rho_{A6} \cdot c_A}{\rho_{A5} \cdot c_A + \rho_{A6} \cdot c_A} \cdot \sigma_{A5.I} = 0.558 \cdot \text{MPa}$$

Transmitted stress wave, fifth layer in Rod A

$$\sigma_{A5.T} - \sigma_{A5.R} = 0.608 \cdot \text{MPa}$$

Transmitted stress wave minus reflected stress wave equals to the initial stress wave, meaning that the fifth layer is in balance

$$U_{PI.A5} := \frac{\sigma_{A5.I}}{\rho_{A5} \cdot c_A} = 0.025 \frac{m}{s}$$

Incident particle velocity, fifth layer of Rod A

$$U_{PR.A5} := \frac{-\sigma_{A5.R}}{\rho_{A5} \cdot c_A} = 2.058 \times 10^{-3} \frac{m}{s}$$

Reflected particle velocity, fifth layer of Rod A

$$U_{PT.A5} := \frac{\sigma_{A5.T}}{\rho_{A6} \cdot c_A} = 0.027 \frac{m}{s}$$

Transmitted particle velocity, fifth layer of Rod A

$$U_{PT.A5} - U_{PR.A5} = 0.025 \frac{m}{s}$$

Transmitted particle velocity minus reflected particle velocity equals to the incident particle velocity, meaning that the fifth layer is in balance

Layer 6:

$$\sigma_{A6.I} := \sigma_{A5.T} = 0.558 \cdot \text{MPa}$$

Incident stress wave

$$\sigma_{A6.R} := \frac{\rho_{A7} \cdot c_A - \rho_{A6} \cdot c_A}{\rho_{A7} \cdot c_A + \rho_{A6} \cdot c_A} \cdot \sigma_{A6.I} = -0.055 \cdot \text{MPa} \quad \text{Reflected stress wave, sixth layer in Rod A}$$

$$\sigma_{A6.T} := \frac{2 \cdot \rho_{A7} \cdot c_A}{\rho_{A6} \cdot c_A + \rho_{A7} \cdot c_A} \cdot \sigma_{A6.I} = 0.503 \cdot \text{MPa} \quad \text{Transmitted stress wave, sixth layer in Rod A}$$

$$\sigma_{A6.T} - \sigma_{A6.R} = 0.558 \cdot \text{MPa} \quad \text{Transmitted stress wave minus reflected stress wave equals to the initial stress wave, meaning that the sixth layer is in balance}$$

$$U_{PI.A6} := \frac{\sigma_{A6.I}}{\rho_{A6} \cdot c_A} = 0.027 \frac{\text{m}}{\text{s}} \quad \text{Incident particle velocity, sixth layer of Rod A}$$

$$U_{PR.A6} := \frac{-\sigma_{A6.R}}{\rho_{A6} \cdot c_A} = 2.661 \times 10^{-3} \frac{\text{m}}{\text{s}} \quad \text{Reflected particle velocity, sixth layer of Rod A}$$

$$U_{PT.A6} := \frac{\sigma_{A6.T}}{\rho_{A7} \cdot c_A} = 0.03 \frac{\text{m}}{\text{s}} \quad \text{Transmitted particle velocity, sixth layer of Rod A}$$

$$U_{PT.A6} - U_{PR.A6} = 0.027 \frac{\text{m}}{\text{s}} \quad \text{Transmitted particle velocity minus reflected particle velocity equals to the incident particle velocity, meaning that the sixth layer is in balance}$$

Layer 7:

$$\sigma_{A7.I} := \sigma_{A6.T} = 0.503 \cdot \text{MPa} \quad \text{Incident stress wave}$$

$$\sigma_{A7.R} := \frac{\rho_{A8} \cdot c_A - \rho_{A7} \cdot c_A}{\rho_{A8} \cdot c_A + \rho_{A7} \cdot c_A} \cdot \sigma_{A7.I} = -0.061 \cdot \text{MPa} \quad \text{Reflected stress wave, seventh layer in Rod A}$$

$$\sigma_{A7.T} := \frac{2 \cdot \rho_{A8} \cdot c_A}{\rho_{A7} \cdot c_A + \rho_{A8} \cdot c_A} \cdot \sigma_{A7.I} = 0.442 \cdot \text{MPa} \quad \text{Transmitted stress wave, seventh layer in Rod A}$$

$$\sigma_{A7.T} - \sigma_{A7.R} = 0.503 \cdot \text{MPa}$$

Transmitted stress wave minus reflected stress wave equals to the initial stress wave, meaning that the seventh layer is in balance

$$U_{PI.A7} := \frac{\sigma_{A7.I}}{\rho_{A7} \cdot c_A} = 0.03 \frac{\text{m}}{\text{s}}$$

Incident particle velocity, seventh layer of Rod A

$$U_{PR.A7} := \frac{-\sigma_{A7.R}}{\rho_{A7} \cdot c_A} = 3.632 \times 10^{-3} \frac{\text{m}}{\text{s}}$$

Reflected particle velocity, seventh layer of Rod A

$$U_{PT.A7} := \frac{\sigma_{A7.T}}{\rho_{A8} \cdot c_A} = 0.034 \frac{\text{m}}{\text{s}}$$

Transmitted particle velocity, seventh layer of Rod A

$$U_{PT.A7} - U_{PR.A7} = 0.03 \frac{\text{m}}{\text{s}}$$

Transmitted particle velocity minus reflected particle velocity equals to the incident particle velocity, meaning that the seventh layer is in balance

Layer 8:

$$\sigma_{A8.I} := \sigma_{A7.T} = 0.442 \cdot \text{MPa}$$

Incident stress wave

$$\sigma_{A8.R} := \frac{\rho_{A9} \cdot c_A - \rho_{A8} \cdot c_A}{\rho_{A9} \cdot c_A + \rho_{A8} \cdot c_A} \cdot \sigma_{A8.I} = -0.071 \cdot \text{MPa}$$

Reflected stress wave, eighth layer in Rod A

$$\sigma_{A8.T} := \frac{2 \cdot \rho_{A9} \cdot c_A}{\rho_{A8} \cdot c_A + \rho_{A9} \cdot c_A} \cdot \sigma_{A8.I} = 0.371 \cdot \text{MPa}$$

Transmitted stress wave, eighth layer in Rod A

$$\sigma_{A8.T} - \sigma_{A8.R} = 0.442 \cdot \text{MPa}$$

Transmitted stress wave minus reflected stress wave equals to the initial stress wave, meaning that the eighth layer is in balance

$$U_{PI.A8} := \frac{\sigma_{A8.I}}{\rho_{A8} \cdot c_A} = 0.034 \frac{\text{m}}{\text{s}}$$

Incident particle velocity, eighth layer of Rod A

$$U_{PR.A8} := \frac{-\sigma_{A8.R}}{\rho_{A8} \cdot c_A} = 5.385 \times 10^{-3} \frac{m}{s}$$

Reflected particle velocity, eighth layer of Rod A

$$U_{PT.A8} := \frac{\sigma_{A8.T}}{\rho_{A9} \cdot c_A} = 0.039 \frac{m}{s}$$

Transmitted particle velocity, eighth layer of Rod A

$$U_{PT.A8} - U_{PR.A8} = 0.034 \frac{m}{s}$$

Transmitted particle velocity minus reflected particle velocity equals to the incident particle velocity, meaning that the eighth layer is in balance

Layer 9:

$$\sigma_{A9.I} := \sigma_{A8.T} = 0.371 \cdot \text{MPa}$$

Incident stress wave

$$\sigma_{A9.R} := \frac{\rho_{A10} \cdot c_A - \rho_{A9} \cdot c_A}{\rho_{A10} \cdot c_A + \rho_{A9} \cdot c_A} \cdot \sigma_{A9.I} = -0.088 \cdot \text{MPa}$$

Reflected stress wave, ninth layer in Rod A

$$\sigma_{A9.T} := \frac{2 \cdot \rho_{A10} \cdot c_A}{\rho_{A9} \cdot c_A + \rho_{A10} \cdot c_A} \cdot \sigma_{A9.I} = 0.283 \cdot \text{MPa}$$

Transmitted stress wave, ninth layer in Rod A

$$\sigma_{A9.T} - \sigma_{A9.R} = 0.371 \cdot \text{MPa}$$

Transmitted stress wave minus reflected stress wave equals to the initial stress wave, meaning that the ninth layer is in balance

$$U_{PI.A9} := \frac{\sigma_{A9.I}}{\rho_{A9} \cdot c_A} = 0.039 \frac{m}{s}$$

Incident particle velocity, ninth layer of Rod A

$$U_{PR.A9} := \frac{-\sigma_{A9.R}}{\rho_{A9} \cdot c_A} = 9.21 \times 10^{-3} \frac{m}{s}$$

Reflected particle velocity, ninth layer of Rod A

$$U_{PT.A9} := \frac{\sigma_{A9.T}}{\rho_{A10} \cdot c_A} = 0.048 \frac{m}{s}$$

Transmitted particle velocity, ninth layer of Rod A

$$U_{PT.A9} - U_{PR.A9} = 0.039 \frac{\text{m}}{\text{s}}$$

Transmitted particle velocity minus reflected particle velocity equals to the incident particle velocity, meaning that the ninth layer is in balance

Layer 10:

$$\sigma_{A10.I} := \sigma_{A9.T} = 0.283 \cdot \text{MPa}$$

Incident stress wave

$$\sigma_{A10.R} := \sigma_{A9.T} = 0.283 \cdot \text{MPa}$$

Reflected stress wave, tenth layer in Rod A

No transmitted stress wave in tenth layer

$$\sigma_{A10.I} + \sigma_{A10.R} = 0.566 \cdot \text{MPa}$$

Balance in the layer

$$U_{PI.A10} := \frac{\sigma_{A10.I}}{\rho_{A10} \cdot c_A} = 0.048 \frac{\text{m}}{\text{s}}$$

Incident particle velocity, tenth layer of Rod A

$$U_{PR.A10} := U_{PI.A10} = 0.048 \frac{\text{m}}{\text{s}}$$

Reflected particle velocity, tenth layer of Rod A

No transmitted stress wave in tenth layer

$$U_{PR.A10} - U_{PI.A10} = 0 \frac{\text{m}}{\text{s}}$$

Balance in the layer

Material parameters Rod B

Material parameters is calculated from Mathematica

Young's modulus:

Density:

Wave velocity:

$$E_{B1} := 1.00275 \cdot 10^{10} \cdot \text{Pa}$$

$$\rho_{B1} := 149935 \cdot \frac{\text{kg}}{\text{m}^3}$$

$$c_{B1} := \sqrt{\frac{E_{B1}}{\rho_{B1}}} = 258.61 \frac{\text{m}}{\text{s}}$$

$$E_{B2} := 2.72475 \cdot 10^{10} \cdot \text{Pa}$$

$$\rho_{B2} := 45268.3 \cdot \frac{\text{kg}}{\text{m}^3}$$

$$c_{B2} := \sqrt{\frac{E_{B2}}{\rho_{B2}}} = 775.829 \frac{\text{m}}{\text{s}}$$

$$E_{B3} := 4.06875 \cdot 10^{10} \cdot \text{Pa}$$

$$\rho_{B3} := 24335 \cdot \frac{\text{kg}}{\text{m}^3}$$

$$c_{B3} := \sqrt{\frac{E_{B3}}{\rho_{B3}}} = 1.293 \times 10^3 \frac{\text{m}}{\text{s}}$$

$$E_{B4} := 5.03475 \cdot 10^{10} \cdot \text{Pa}$$

$$\rho_{B4} := 15363.6 \cdot \frac{\text{kg}}{\text{m}^3}$$

$$c_{B4} := \sqrt{\frac{E_{B4}}{\rho_{B4}}} = 1.81 \times 10^3 \frac{\text{m}}{\text{s}}$$

$$E_{B5} := 5.622 \cdot 10^{10} \cdot \text{Pa}$$

$$\rho_{B5} := 10379.2 \cdot \frac{\text{kg}}{\text{m}^3}$$

$$c_{B5} := \sqrt{\frac{E_{B5}}{\rho_{B5}}} = 2.327 \times 10^3 \frac{\text{m}}{\text{s}}$$

$$E_{B6} := 5.83275 \cdot 10^{10} \cdot \text{Pa}$$

$$\rho_{B6} := 7207.73 \cdot \frac{\text{kg}}{\text{m}^3}$$

$$c_{B6} := \sqrt{\frac{E_{B6}}{\rho_{B6}}} = 2.845 \times 10^3 \frac{\text{m}}{\text{s}}$$

$$E_{B7} := 5.66475 \cdot 10^{10} \cdot \text{Pa}$$

$$\rho_{B7} := 5011.92 \cdot \frac{\text{kg}}{\text{m}^3}$$

$$c_{B7} := \sqrt{\frac{E_{B7}}{\rho_{B7}}} = 3.362 \times 10^3 \frac{\text{m}}{\text{s}}$$

$$E_{B8} := 5.11875 \cdot 10^{10} \cdot \text{Pa}$$

$$\rho_{B8} := 3401.67 \cdot \frac{\text{kg}}{\text{m}^3}$$

$$c_{B8} := \sqrt{\frac{E_{B8}}{\rho_{B8}}} = 3.879 \times 10^3 \frac{\text{m}}{\text{s}}$$

$$E_{B9} := 4.19475 \cdot 10^{10} \cdot \text{Pa}$$

$$\rho_{B9} := 2170.29 \cdot \frac{\text{kg}}{\text{m}^3}$$

$$c_{B9} := \sqrt{\frac{E_{B9}}{\rho_{B9}}} = 4.396 \times 10^3 \frac{\text{m}}{\text{s}}$$

$$E_{B10} := 2.89275 \cdot 10^{10} \cdot \text{Pa}$$

$$\rho_{B10} := 1198.16 \cdot \frac{\text{kg}}{\text{m}^3}$$

$$c_{B10} := \sqrt{\frac{E_{B10}}{\rho_{B10}}} = 4.914 \times 10^3 \frac{\text{m}}{\text{s}}$$

Stresses Rod B

Layer 1:

$$\sigma_{B1.I} := \frac{F}{A} = 0.775 \cdot \text{MPa}$$

Initial stress wave of Rod A and B

$$\sigma_{B1.R} := \frac{\rho_{B2} \cdot c_{B2} - \rho_{B1} \cdot c_{B1}}{\rho_{B2} \cdot c_{B2} + \rho_{B1} \cdot c_{B1}} \cdot \sigma_{I1} = -0.038 \cdot \text{MPa}$$

Reflected stress wave, first layer in Rod B

$$\sigma_{B1.T} := \frac{2 \cdot \rho_{B2} \cdot c_{B2}}{\rho_{B1} \cdot c_{B1} + \rho_{B2} \cdot c_{B2}} \cdot \sigma_{I1} = 0.737 \cdot \text{MPa}$$

Transmitted stress wave, first layer in Rod B

$$\sigma_{B1.T} - \sigma_{A1.R} = 0.775 \cdot \text{MPa}$$

Transmitted stress wave minus reflected stress wave equals to the initial stress wave, meaning that the first layer is in balance

$$U_{PI.B1} := \frac{\sigma_{B1.I}}{\rho_{B1} \cdot c_{B1}} = 0.02 \frac{\text{m}}{\text{s}}$$

Initial particle velocity, first layer of Rod B

$$U_{PR.B1} := \frac{-\sigma_{B1.R}}{\rho_{B1} \cdot c_{B1}} = 9.886 \times 10^{-4} \frac{\text{m}}{\text{s}}$$

Reflected particle velocity, first layer of Rod B

$$U_{PT.B1} := \frac{\sigma_{B1.T}}{\rho_{B2} \cdot c_{B2}} = 0.021 \frac{\text{m}}{\text{s}}$$

Transmitted particle velocity, first layer of Rod B

$$U_{PT.B1} - U_{PR.B1} = 0.02 \frac{\text{m}}{\text{s}}$$

Transmitted particle velocity minus reflected particle velocity equals to the initial particle velocity, meaning that the first layer is in balance

Layer 2:

$\sigma_{B2.I} := \sigma_{B1.T} = 0.737 \cdot \text{MPa}$	Incident stress wave
$\sigma_{B2.R} := \frac{\rho_{B3} \cdot c_{B3} - \rho_{B2} \cdot c_{B2}}{\rho_{B3} \cdot c_{B3} + \rho_{B2} \cdot c_{B2}} \cdot \sigma_{B2.I} = -0.04 \cdot \text{MPa}$	Reflected stress wave, second layer in Rod B
$\sigma_{B2.T} := \frac{2 \cdot \rho_{B3} \cdot c_{B3}}{\rho_{B2} \cdot c_{B2} + \rho_{B3} \cdot c_{B3}} \cdot \sigma_{B2.I} = 0.696 \cdot \text{MPa}$	Transmitted stress wave, second layer in Rod B
$\sigma_{B2.T} - \sigma_{B2.R} = 0.737 \cdot \text{MPa}$	Transmitted stress wave minus reflected stress wave equals to the initial stress wave, meaning that the second layer is in balance
$U_{PI.B2} := \frac{\sigma_{B2.I}}{\rho_{B2} \cdot c_{B2}} = 0.021 \frac{\text{m}}{\text{s}}$	Incident particle velocity, second layer of Rod B
$U_{PR.B2} := \frac{-\sigma_{B2.R}}{\rho_{B2} \cdot c_{B2}} = 1.151 \times 10^{-3} \frac{\text{m}}{\text{s}}$	Reflected particle velocity, second layer of Rod B
$U_{PT.B2} := \frac{\sigma_{B2.T}}{\rho_{B3} \cdot c_{B3}} = 0.022 \frac{\text{m}}{\text{s}}$	Transmitted particle velocity, second layer of Rod B
$U_{PT.B2} - U_{PR.B2} = 0.021 \frac{\text{m}}{\text{s}}$	Transmitted particle velocity minus reflected particle velocity equals to the incident particle velocity, meaning that the second layer is in balance

Layer 3:

$\sigma_{B3.I} := \sigma_{B2.T} = 0.696 \cdot \text{MPa}$	Incident stress wave
$\sigma_{B3.R} := \frac{\rho_{B4} \cdot c_{B4} - \rho_{B3} \cdot c_{B3}}{\rho_{B4} \cdot c_{B4} + \rho_{B3} \cdot c_{B3}} \cdot \sigma_{B3.I} = -0.043 \cdot \text{MPa}$	Reflected stress wave, third layer in Rod B

$$\sigma_{B3.T} := \frac{2 \cdot \rho_{B4} \cdot c_{B4}}{\rho_{B3} \cdot c_{B3} + \rho_{B4} \cdot c_{B4}} \cdot \sigma_{B3.I} = 0.653 \cdot \text{MPa}$$

Transmitted stress wave, third layer in Rod B

$$\sigma_{B3.T} - \sigma_{B3.R} = 0.696 \cdot \text{MPa}$$

Transmitted stress wave minus reflected stress wave equals to the initial stress wave, meaning that the third layer is in balance

$$U_{PI.B3} := \frac{\sigma_{B3.I}}{\rho_{B3} \cdot c_{B3}} = 0.022 \frac{\text{m}}{\text{s}}$$

Incident particle velocity, third layer of Rod B

$$U_{PR.B3} := \frac{-\sigma_{B3.R}}{\rho_{B3} \cdot c_{B3}} = 1.364 \times 10^{-3} \frac{\text{m}}{\text{s}}$$

Reflected particle velocity, third layer of Rod B

$$U_{PT.B3} := \frac{\sigma_{B3.T}}{\rho_{B4} \cdot c_{B4}} = 0.023 \frac{\text{m}}{\text{s}}$$

Transmitted particle velocity, third layer of Rod B

$$U_{PT.B3} - U_{PR.B3} = 0.022 \frac{\text{m}}{\text{s}}$$

Transmitted particle velocity minus reflected particle velocity equals to the incident particle velocity, meaning that the third layer is in balance

Layer 4:

$$\sigma_{B4.I} := \sigma_{B3.T} = 0.653 \cdot \text{MPa}$$

Incident stress wave

$$\sigma_{B4.R} := \frac{\rho_{B5} \cdot c_{B5} - \rho_{B4} \cdot c_{B4}}{\rho_{B5} \cdot c_{B5} + \rho_{B4} \cdot c_{B4}} \cdot \sigma_{B4.I} = -0.046 \cdot \text{MPa}$$

Reflected stress wave, fourth layer in Rod B

$$\sigma_{B4.T} := \frac{2 \cdot \rho_{B5} \cdot c_{B5}}{\rho_{B4} \cdot c_{B4} + \rho_{B5} \cdot c_{B5}} \cdot \sigma_{B4.I} = 0.608 \cdot \text{MPa}$$

Transmitted stress wave, fourth layer in Rod B

$$\sigma_{B4.T} - \sigma_{B4.R} = 0.653 \cdot \text{MPa}$$

Transmitted stress wave minus reflected stress wave equals to the initial stress wave, meaning that the fourth layer is in balance

$$U_{PI.B4} := \frac{\sigma_{B4.I}}{\rho_{B4} \cdot c_{B4}} = 0.023 \frac{\text{m}}{\text{s}}$$

Incident particle velocity, fourth layer of Rod B

$$U_{PR.B4} := \frac{-\sigma_{B4.R}}{\rho_{B4} \cdot c_{B4}} = 1.653 \times 10^{-3} \frac{m}{s}$$

Reflected particle velocity, fourth layer of Rod B

$$U_{PT.B4} := \frac{\sigma_{B4.T}}{\rho_{B5} \cdot c_{B5}} = 0.025 \frac{m}{s}$$

Transmitted particle velocity, fourth layer of Rod B

$$U_{PT.B4} - U_{PR.B4} = 0.023 \frac{m}{s}$$

Transmitted particle velocity minus reflected particle velocity equals to the incident particle velocity, meaning that the fourth layer is in balance

Layer 5:

$$\sigma_{B5.I} := \sigma_{B4.T} = 0.608 \cdot \text{MPa}$$

Incident stress wave

$$\sigma_{B5.R} := \frac{\rho_{B6} \cdot c_{B6} - \rho_{B5} \cdot c_{B5}}{\rho_{B6} \cdot c_{B6} + \rho_{B5} \cdot c_{B5}} \cdot \sigma_{B5.I} = -0.05 \cdot \text{MPa}$$

Reflected stress wave, fifth layer in Rod B

$$\sigma_{B5.T} := \frac{2 \cdot \rho_{B6} \cdot c_{B6}}{\rho_{B5} \cdot c_{B5} + \rho_{B6} \cdot c_{B6}} \cdot \sigma_{B5.I} = 0.558 \cdot \text{MPa}$$

Transmitted stress wave, fifth layer in Rod B

$$\sigma_{B5.T} - \sigma_{B5.R} = 0.608 \cdot \text{MPa}$$

Transmitted stress wave minus reflected stress wave equals to the initial stress wave, meaning that the fifth layer is in balance

$$U_{PI.B5} := \frac{\sigma_{B5.I}}{\rho_{B5} \cdot c_{B5}} = 0.025 \frac{m}{s}$$

Incident particle velocity, fifth layer of Rod B

$$U_{PR.B5} := \frac{-\sigma_{B5.R}}{\rho_{B5} \cdot c_{B5}} = 2.057 \times 10^{-3} \frac{m}{s}$$

Reflected particle velocity, fifth layer of Rod B

$$U_{PT.B5} := \frac{\sigma_{B5.T}}{\rho_{B6} \cdot c_{B6}} = 0.027 \frac{m}{s}$$

Transmitted particle velocity, fifth layer of Rod B

$$U_{PT.B5} - U_{PR.B5} = 0.025 \frac{m}{s}$$

Transmitted particle velocity minus reflected particle velocity equals to the incident particle velocity, meaning that the fifth layer is in balance

Layer 6:

$$\sigma_{B6.I} := \sigma_{B5.T} = 0.558 \cdot \text{MPa}$$

Incident stress wave

$$\sigma_{B6.R} := \frac{\rho_{B7} \cdot c_{B7} - \rho_{B6} \cdot c_{B6}}{\rho_{B7} \cdot c_{B7} + \rho_{B6} \cdot c_{B6}} \cdot \sigma_{B6.I} = -0.055 \cdot \text{MPa}$$

Reflected stress wave, sixth layer in Rod B

$$\sigma_{B6.T} := \frac{2 \cdot \rho_{B7} \cdot c_{B7}}{\rho_{B6} \cdot c_{B6} + \rho_{B7} \cdot c_{B7}} \cdot \sigma_{B6.I} = 0.503 \cdot \text{MPa}$$

Transmitted stress wave, sixth layer in Rod B

$$\sigma_{B6.T} - \sigma_{B6.R} = 0.558 \cdot \text{MPa}$$

Transmitted stress wave minus reflected stress wave equals to the initial stress wave, meaning that the sixth layer is in balance

$$U_{PI.B6} := \frac{\sigma_{B6.I}}{\rho_{B6} \cdot c_{B6}} = 0.027 \frac{\text{m}}{\text{s}}$$

Incident particle velocity, sixth layer of Rod B

$$U_{PR.B6} := \frac{-\sigma_{B6.R}}{\rho_{B6} \cdot c_{B6}} = 2.661 \times 10^{-3} \frac{\text{m}}{\text{s}}$$

Reflected particle velocity, sixth layer of Rod B

$$U_{PT.B6} := \frac{\sigma_{B6.T}}{\rho_{B7} \cdot c_{B7}} = 0.03 \frac{\text{m}}{\text{s}}$$

Transmitted particle velocity, sixth layer of Rod B

$$U_{PT.B6} - U_{PR.B6} = 0.027 \frac{\text{m}}{\text{s}}$$

Transmitted particle velocity minus reflected particle velocity equals to the incident particle velocity, meaning that the sixth layer is in balance

Layer 7:

$$\sigma_{B7.I} := \sigma_{B6.T} = 0.503 \cdot \text{MPa}$$

Incident stress wave

$$\sigma_{B7.R} := \frac{\rho_{B8} \cdot c_{B8} - \rho_{B7} \cdot c_{B7}}{\rho_{B8} \cdot c_{B8} + \rho_{B7} \cdot c_{B7}} \cdot \sigma_{B7.I} = -0.061 \cdot \text{MPa}$$

Reflected stress wave, seventh layer in Rod B

$$\sigma_{B7.T} := \frac{2 \cdot \rho_{B8} \cdot c_{B8}}{\rho_{B7} \cdot c_{B7} + \rho_{B8} \cdot c_{B8}} \cdot \sigma_{B7.I} = 0.442 \cdot \text{MPa}$$

Transmitted stress wave, seventh layer in Rod B

$$\sigma_{B7.T} - \sigma_{B7.R} = 0.503 \cdot \text{MPa}$$

Transmitted stress wave minus reflected stress wave equals to the initial stress wave, meaning that the seventh layer is in balance

$$U_{PI.B7} := \frac{\sigma_{B7.I}}{\rho_{B7} \cdot c_{B7}} = 0.03 \frac{\text{m}}{\text{s}}$$

Incident particle velocity, seventh layer of Rod B

$$U_{PR.B7} := \frac{-\sigma_{B7.R}}{\rho_{B7} \cdot c_{B7}} = 3.633 \times 10^{-3} \frac{\text{m}}{\text{s}}$$

Reflected particle velocity, seventh layer of Rod B

$$U_{PT.B7} := \frac{\sigma_{B7.T}}{\rho_{B8} \cdot c_{B8}} = 0.034 \frac{\text{m}}{\text{s}}$$

Transmitted particle velocity, seventh layer of Rod B

$$U_{PT.B7} - U_{PR.B7} = 0.03 \frac{\text{m}}{\text{s}}$$

Transmitted particle velocity minus reflected particle velocity equals to the incident particle velocity, meaning that the seventh layer is in balance

Layer 8:

$$\sigma_{B8.I} := \sigma_{B7.T} = 0.442 \cdot \text{MPa}$$

Incident stress wave

$$\sigma_{B8.R} := \frac{\rho_{B9} \cdot c_{B9} - \rho_{B8} \cdot c_{B8}}{\rho_{B9} \cdot c_{B9} + \rho_{B8} \cdot c_{B8}} \cdot \sigma_{B8.I} = -0.071 \cdot \text{MPa}$$

Reflected stress wave, eighth layer in Rod B

$$\sigma_{B8.T} := \frac{2 \cdot \rho_{B9} \cdot c_{B9}}{\rho_{B8} \cdot c_{B8} + \rho_{B9} \cdot c_{B9}} \cdot \sigma_{B8.I} = 0.371 \cdot \text{MPa}$$

Transmitted stress wave, eighth layer in Rod B

$$\sigma_{B8.T} - \sigma_{B8.R} = 0.442 \cdot \text{MPa}$$

Transmitted stress wave minus reflected stress wave equals to the initial stress wave, meaning that the eighth layer is in balance

$$U_{PI.B8} := \frac{\sigma_{B8.I}}{\rho_{B8} \cdot c_{B8}} = 0.034 \frac{m}{s}$$

Incident particle velocity, eighth layer of Rod B

$$U_{PR.B8} := \frac{-\sigma_{B8.R}}{\rho_{B8} \cdot c_{B8}} = 5.384 \times 10^{-3} \frac{m}{s}$$

Reflected particle velocity, eighth layer of Rod B

$$U_{PT.B8} := \frac{\sigma_{B8.T}}{\rho_{B9} \cdot c_{B9}} = 0.039 \frac{m}{s}$$

Transmitted particle velocity, eighth layer of Rod B

$$U_{PT.B8} - U_{PR.B8} = 0.034 \frac{m}{s}$$

Transmitted particle velocity minus reflected particle velocity equals to the incident particle velocity, meaning that the eighth layer is in balance

Layer 9:

$$\sigma_{B9.I} := \sigma_{B8.T} = 0.371 \cdot \text{MPa}$$

Incident stress wave

$$\sigma_{B9.R} := \frac{\rho_{B10} \cdot c_{B10} - \rho_{B9} \cdot c_{B9}}{\rho_{B10} \cdot c_{B10} + \rho_{B9} \cdot c_{B9}} \cdot \sigma_{B9.I} = -0.088 \cdot \text{MPa}$$

Reflected stress wave, ninth layer in Rod B

$$\sigma_{B9.T} := \frac{2 \cdot \rho_{B10} \cdot c_{B10}}{\rho_{B9} \cdot c_{B9} + \rho_{B10} \cdot c_{B10}} \cdot \sigma_{B9.I} = 0.283 \cdot \text{MPa}$$

Transmitted stress wave, ninth layer in Rod B

$$\sigma_{B9.T} - \sigma_{B9.R} = 0.371 \cdot \text{MPa}$$

Transmitted stress wave minus reflected stress wave equals to the initial stress wave, meaning that the ninth layer is in balance

$$U_{PI.B9} := \frac{\sigma_{B9.I}}{\rho_{B9} \cdot c_{B9}} = 0.039 \frac{m}{s}$$

Incident particle velocity, ninth layer of Rod B

$$U_{PR.B9} := \frac{-\sigma_{B9.R}}{\rho_{B9} \cdot c_{B9}} = 9.209 \times 10^{-3} \frac{m}{s}$$

Reflected particle velocity, ninth layer of Rod B

$$U_{PT.B9} := \frac{\sigma_{B9.T}}{\rho_{B10} \cdot c_{B10}} = 0.048 \frac{m}{s}$$

Transmitted particle velocity, ninth layer of Rod B

$$U_{PT.B9} - U_{PR.B9} = 0.039 \frac{m}{s}$$

Transmitted particle velocity minus reflected particle velocity equals to the incident particle velocity, meaning that the ninth layer is in balance

Layer 10:

$$\sigma_{B10.I} := \sigma_{B9.T} = 0.283 \cdot \text{MPa}$$

Incident stress wave

$$\sigma_{B10.R} := \sigma_{B9.T} = 0.283 \cdot \text{MPa}$$

Reflected stress wave, tenth layer in Rod B

No transmitted stress wave in tenth layer

$$\sigma_{B10.I} + \sigma_{B10.R} = 0.566 \cdot \text{MPa}$$

Balance in the layer

$$U_{PI.B10} := \frac{\sigma_{B10.I}}{\rho_{B10} \cdot c_{B10}} = 0.048 \frac{m}{s}$$

Incident particle velocity, tenth layer of Rod B

$$U_{PR.B10} := U_{PI.B10} = 0.048 \frac{m}{s}$$

Reflected particle velocity, tenth layer of Rod B

No transmitted stress wave in tenth layer

$$U_{PR.B10} - U_{PI.B10} = 0 \frac{m}{s}$$

Balance in the layer

D Material properties and dynamic response calculations, Case study 4

Calculation of material parameters for case studie four and plots

Defines the new third grade polynomial psi function where it is possible to define specific parameters such as the derivative in both ends

```
poly2[y_] = InterpolatingPolynomial[{{{0}, 0, 1}, {{1},  $\frac{1}{2}$ ,  $\frac{1}{2}$ }}, x] /. {x -> y}
```

$$y \left(1 + \left(-\frac{1}{2} + \frac{1}{2} (-1 + y) \right) y \right)$$

```
psi = poly2
```

```
poly2
```

```
psiinv = invpoly2
```

```
invpoly2
```

Defines the material functions for Young's modulus and the density

```
ClearAll[E0, rho0]; E0 =  $210. \times 10^9$ ; rho0 = 7850.;
```

$$\mathbf{Emod}[x_] := \mathbf{E0} \left(\frac{1}{10} x + (1 - x) \right)$$

$$\rho[x_] := \rho0 \left(\frac{1}{10} x + (1 - x) \right)$$

Plots the different material curves for the material properties

```
emod = Plot[Emod[x], {x, 0, 1}, PlotStyle -> GrayLevel[0],  
AxesOrigin -> {0, 0}, AxesLabel -> {m, Pa}, LabelStyle -> {Black}]
```

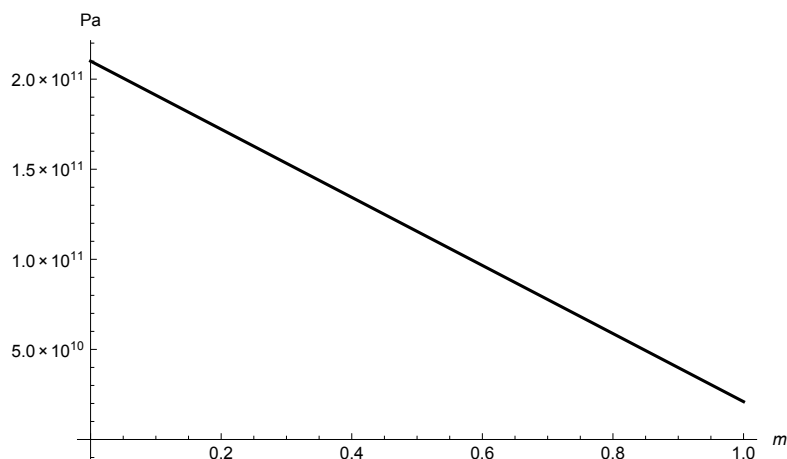

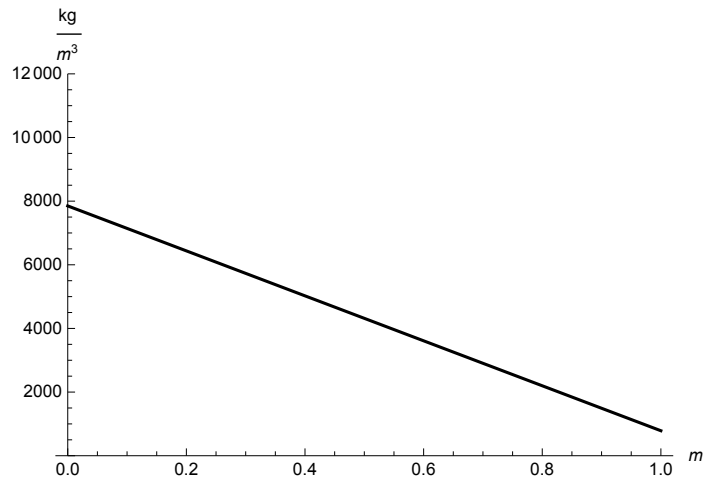

```
rho = Plot[ $\rho[x]$ , {x, 0, 1}, PlotStyle -> GrayLevel[0], AxesOrigin -> {0, 0},
  PlotRange -> {12000, 0}, AxesLabel -> {m, kg/m^3}, LabelStyle -> {Black}]
```

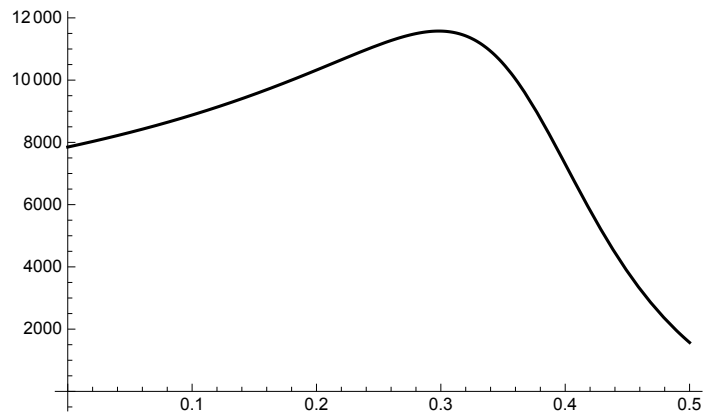

```
rhohat = Plot[ $\frac{\rho[\psi\text{inv}[x]]}{\beta[x]}$ , {x, 0,  $\frac{1}{2}$ }, PlotStyle -> GrayLevel[0], AxesOrigin -> {0, 0}]
```

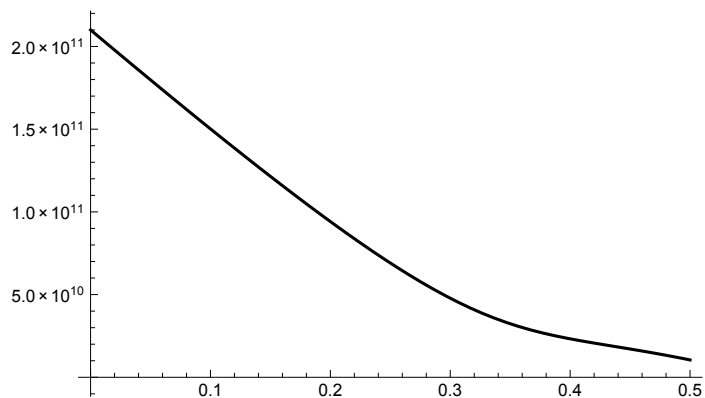

```
ehat = Plot[Emod[psiinv[x]] beta[x], {x, 0,  $\frac{1}{2}$ },
  PlotStyle -> GrayLevel[0], AxesOrigin -> {0, 0}]
```



```
Plot[Emod[ψinv[x]], {x, 0, 1}, AxesOrigin -> {0, 0}]
```

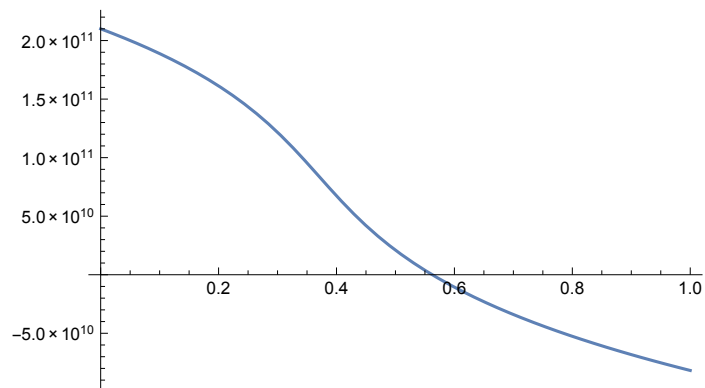

Defines the inverse function of psi and calculating the beta function

```
invpoly2[x_] :=
```

$$\frac{2}{3} - \frac{2}{3 \left(-10 + 27x + 3\sqrt{3} \sqrt{4 - 20x + 27x^2} \right)^{1/3}} + \frac{1}{3} \left(-10 + 27x + 3\sqrt{3} \sqrt{4 - 20x + 27x^2} \right)^{1/3}$$

```
β[x_] := poly2'[invpoly2[x]]
```

Plots the variation of beta and the wave velocity for the original and transformed bar

```
Plot[β[x], {x, 0, 1}, PlotStyle -> GrayLevel[0], AxesOrigin -> {0, 0}]
```

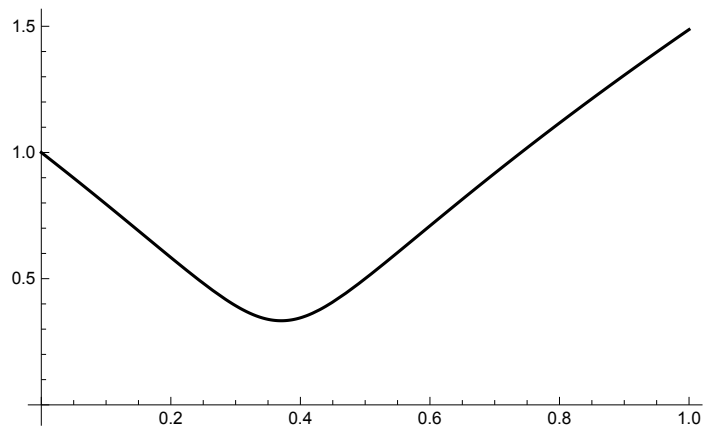

```

vel1 = Plot[ $\sqrt{\frac{\text{Emod}[x]}{\rho[x]}}$ , {x, 0, 1}, PlotStyle -> GrayLevel[0],
  AxesOrigin -> {0, 0}, AxesLabel -> {m, m / s}, LabelStyle -> {Black}]

```

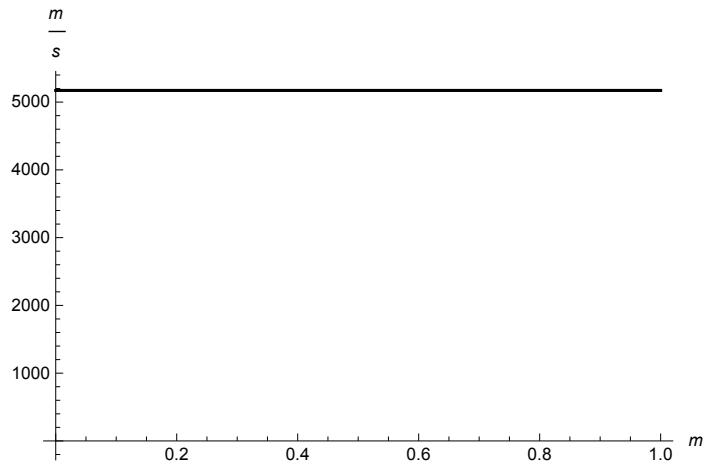

```

vel2 = Plot[ $\sqrt{\frac{\text{Emod}[\psi\text{inv}[x]] \beta[x]}{\frac{\rho[\psi\text{inv}[x]]}{\beta[x]}}}$ ,
  {x, 0, 0.5}, PlotStyle -> GrayLevel[0], AxesOrigin -> {0, 0}]

```

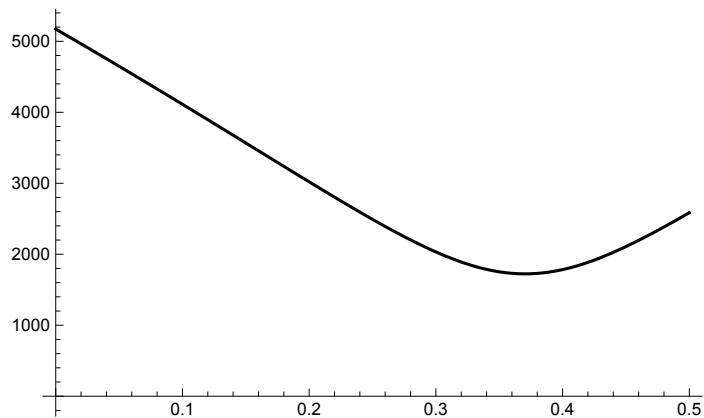

Calculating the material properties from the curves for the transformed and original rods and where the reflections occur

```

MatrixForm[
  Table[{x, x + 0.05, Emod[x], ρ[x], Emod[x] ρ[x], ψ[x]}, {x, 0.05, 1 - 0.05, 0.1}]
]

```

0.05	0.1	2.0055×10^{11}	7496.75	1.50347×10^{15}	0.0475625
0.15	0.2	1.8165×10^{11}	6790.25	1.23345×10^{15}	0.129188
0.25	0.3	1.6275×10^{11}	6083.75	9.9013×10^{14}	0.195313
0.35	0.4	1.4385×10^{11}	5377.25	7.73517×10^{14}	0.248938
0.45	0.5	1.2495×10^{11}	4670.75	5.8361×10^{14}	0.293063
0.55	0.6	1.0605×10^{11}	3964.25	4.20409×10^{14}	0.330688
0.65	0.7	8.715×10^{10}	3257.75	2.83913×10^{14}	0.364813
0.75	0.8	6.825×10^{10}	2551.25	1.74123×10^{14}	0.398438
0.85	0.9	4.935×10^{10}	1844.75	9.10384×10^{13}	0.434563
0.95	1.	3.045×10^{10}	1138.25	3.46597×10^{13}	0.476188

```

MatrixForm[Table[{x,  $\psi[x + 0.05]$ ,  $\beta[\psi[x]]$  Emod[x],
   $\frac{\rho[x]}{\beta[\psi[x]]}$ ,  $\beta[\psi[x]]$  Emod[x]  $\frac{\rho[x]}{\beta[\psi[x]]}$ }, {x, 0.05, 1 - 0.05, 0.1}]]

```

0.05	0.0905	1.81247×10^{11}	8295.16	1.50347×10^{15}
0.15	0.164	1.33286×10^{11}	9254.17	1.23345×10^{15}
0.25	0.2235	9.66328×10^{10}	10246.3	9.9013×10^{14}
0.35	0.272	6.95874×10^{10}	11115.8	7.73517×10^{14}
0.45	0.3125	5.04486×10^{10}	11568.4	5.8361×10^{14}
0.55	0.348	3.75152×10^{10}	11206.4	4.20409×10^{14}
0.65	0.3815	2.90863×10^{10}	9761.05	2.83913×10^{14}
0.75	0.416	2.34609×10^{10}	7421.82	1.74123×10^{14}
0.85	0.4545	1.89381×10^{10}	4807.17	9.10384×10^{13}
0.95	0.5	1.38167×10^{10}	2508.54	3.46597×10^{13}

Plotting the final plots which shows the transformed and original values for Young's modulus the density and the wave velocity

```
emodul = Show[emod, ehat]
```

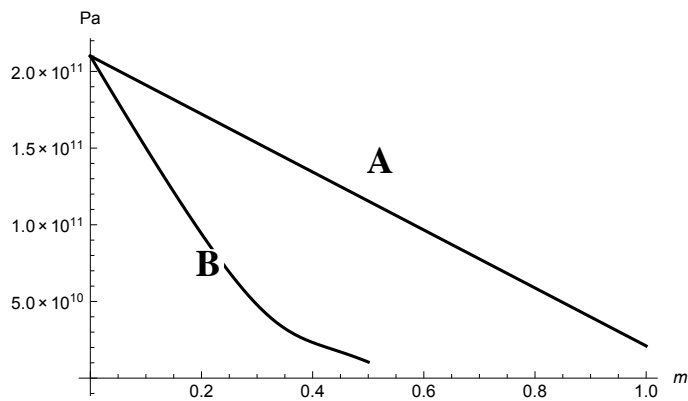

```
densitet = Show[rho, rho hat]
```

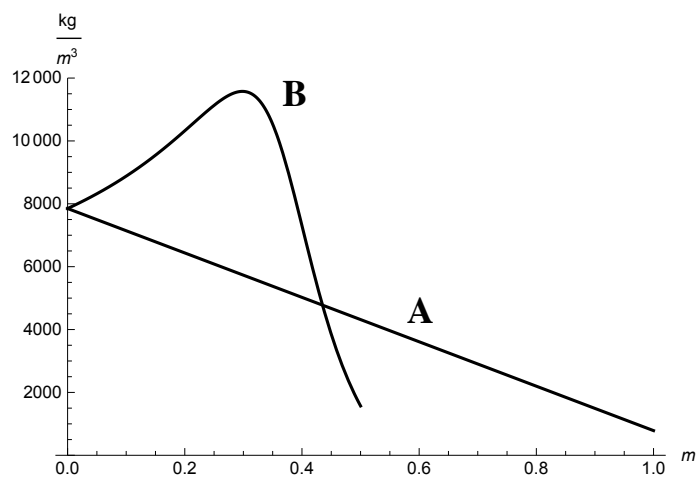

```
velocity = Show[vel1, vel2]
```

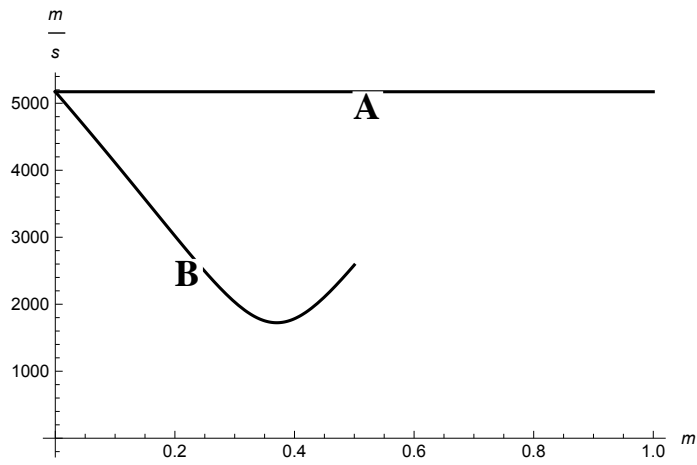

Transformation with x³-function, Case Study 4

Following calculations are made with the theory of elastic wave propagation between different materials. This is done in order to compare two Rods (A and B) with different lengths and material parameters. Stresses and particle velocity for incident, reflected and transmitted waves will be determine and presented below.

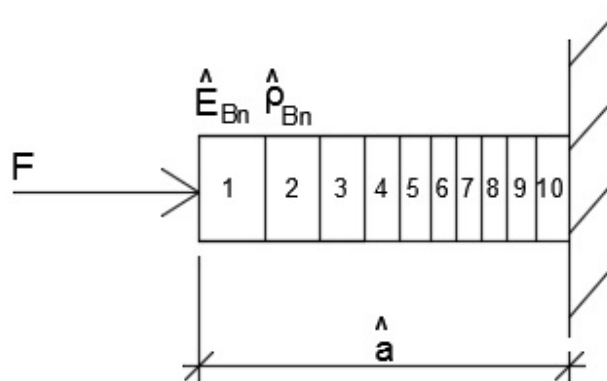
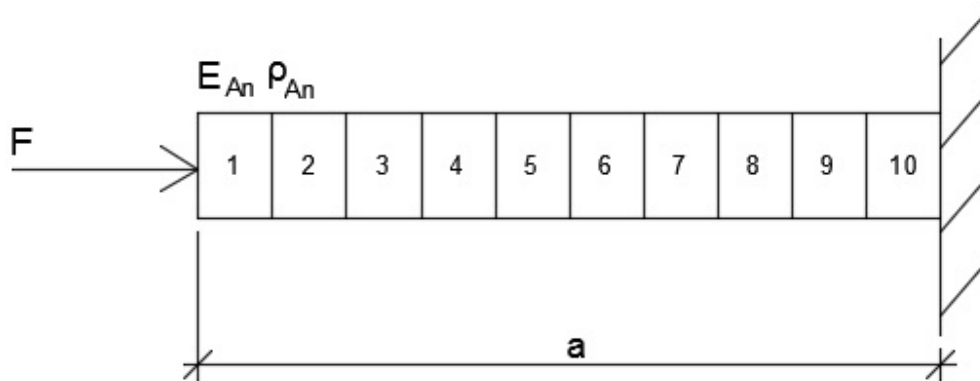

Material parameters Rod A

Material parameters has been calculated in mathematica

Young's modulus:

Density:

$$E_{A1} := 2.006 \cdot 10^{11} \cdot \text{Pa} \quad \rho_{A1} := 7.49675 \cdot 10^3 \cdot \frac{\text{kg}}{\text{m}^3}$$

$$E_{A2} := 1.816 \cdot 10^{11} \cdot \text{Pa} \quad \rho_{A2} := 6.79025 \cdot 10^3 \cdot \frac{\text{kg}}{\text{m}^3}$$

$$E_{A3} := 1.6275 \cdot 10^{11} \cdot \text{Pa} \quad \rho_{A3} := 6.0838 \cdot 10^3 \cdot \frac{\text{kg}}{\text{m}^3}$$

$$\begin{aligned}
 E_{A4} &:= 1.4385 \cdot 10^{11} \cdot \text{Pa} & \rho_{A4} &:= 5.3773 \cdot 10^3 \cdot \frac{\text{kg}}{\text{m}^3} \\
 E_{A5} &:= 1.2495 \cdot 10^{11} \cdot \text{Pa} & \rho_{A5} &:= 4.6708 \cdot 10^3 \cdot \frac{\text{kg}}{\text{m}^3} \\
 E_{A6} &:= 1.0605 \cdot 10^{11} \cdot \text{Pa} & \rho_{A6} &:= 3.9643 \cdot 10^3 \cdot \frac{\text{kg}}{\text{m}^3} \\
 E_{A7} &:= 8.7150 \cdot 10^{10} \cdot \text{Pa} & \rho_{A7} &:= 3.2578 \cdot 10^3 \cdot \frac{\text{kg}}{\text{m}^3} \\
 E_{A8} &:= 6.8250 \cdot 10^{10} \cdot \text{Pa} & \rho_{A8} &:= 2.5513 \cdot 10^3 \cdot \frac{\text{kg}}{\text{m}^3} \\
 E_{A9} &:= 4.9350 \cdot 10^{10} \cdot \text{Pa} & \rho_{A9} &:= 1.8447 \cdot 10^3 \cdot \frac{\text{kg}}{\text{m}^3} \\
 E_{A10} &:= 3.0450 \cdot 10^{10} \cdot \text{Pa} & \rho_{A10} &:= 1.1382 \cdot 10^3 \cdot \frac{\text{kg}}{\text{m}^3}
 \end{aligned}$$

Wave Velocity:

$$c_A := \sqrt{\frac{E_{A1}}{\rho_{A1}}} = 5.173 \times 10^3 \frac{\text{m}}{\text{s}}$$

Same Wave velocity for all materials in rod A

Stresses in Rod A

$$F := 500\text{N}$$

Force at the left end of the Rod A and B

$$A := 6.450 \cdot 10^{-4} \text{m}^2$$

Cross section area of Rod A and B

Layer 1:

$$\sigma_{I1} := \frac{F}{A} = 0.775 \cdot \text{MPa}$$

Initial stress wave of Rod A and B

$$\sigma_{A1.R} := \frac{\rho_{A2} \cdot c_A - \rho_{A1} \cdot c_A}{\rho_{A2} \cdot c_A + \rho_{A1} \cdot c_A} \cdot \sigma_{I1} = -0.038 \cdot \text{MPa}$$

Reflected stress wave, first layer in Rod A

$$\sigma_{A1.T} := \frac{2 \cdot \rho_{A2} \cdot c_A}{\rho_{A1} \cdot c_A + \rho_{A2} \cdot c_A} \cdot \sigma_{I1} = 0.737 \cdot \text{MPa}$$

Transmitted stress wave, first layer in Rod A

$$\sigma_{A1.T} - \sigma_{A1.R} = 0.775 \cdot \text{MPa}$$

Transmitted stress wave minus reflected stress wave equals to the initial stress wave, meaning that the first layer is in balance

$$U_{PI.A1} := \frac{\sigma_{I1}}{\rho_{A1} \cdot c_A} = 0.02 \frac{\text{m}}{\text{s}}$$

Initial particle velocity, first layer of Rod A

$$U_{PR.A1} := \frac{-\sigma_{A1.R}}{\rho_{A1} \cdot c_A} = 9.885 \times 10^{-4} \frac{\text{m}}{\text{s}}$$

Reflected particle velocity, first layer of Rod A

$$U_{PT.A1} := \frac{\sigma_{A1.T}}{\rho_{A2} \cdot c_A} = 0.021 \frac{\text{m}}{\text{s}}$$

Transmitted particle velocity, first layer of Rod A

$$U_{PT.A1} - U_{PR.A1} = 0.02 \frac{\text{m}}{\text{s}}$$

Transmitted particle velocity minus reflected particle velocity equals to the initial particle velocity, meaning that the first layer is in balance

Layer 2:

$$\sigma_{A2.I} := \sigma_{A1.T} = 0.737 \cdot \text{MPa}$$

Incident stress wave

$$\sigma_{A2.R} := \frac{\rho_{A3} \cdot c_A - \rho_{A2} \cdot c_A}{\rho_{A3} \cdot c_A + \rho_{A2} \cdot c_A} \cdot \sigma_{A2.I} = -0.04 \cdot \text{MPa}$$

Reflected stress wave, second layer in Rod A

$$\sigma_{A2.T} := \frac{2 \cdot \rho_{A3} \cdot c_A}{\rho_{A2} \cdot c_A + \rho_{A3} \cdot c_A} \cdot \sigma_{A2.I} = 0.696 \cdot \text{MPa}$$

Transmitted stress wave, second layer in Rod A

$$\sigma_{A2.T} - \sigma_{A2.R} = 0.737 \cdot \text{MPa}$$

Transmitted stress wave minus reflected stress wave equals to the incident stress wave, meaning that the second layer is in balance

$$U_{PI.A2} := \frac{\sigma_{A2.I}}{\rho_{A2} \cdot c_A} = 0.021 \frac{\text{m}}{\text{s}}$$

Incident particle velocity, second second of Rod A

$$U_{PR.A2} := \frac{-\sigma_{A2.R}}{\rho_{A2} \cdot c_A} = 1.151 \times 10^{-3} \frac{\text{m}}{\text{s}}$$

Reflected particle velocity, second layer of Rod A

$$U_{PT.A2} := \frac{\sigma_{A2.T}}{\rho_{A3} \cdot c_A} = 0.022 \frac{\text{m}}{\text{s}}$$

Transmitted particle velocity, second layer of Rod A

$$U_{PT.A2} - U_{PR.A2} = 0.021 \frac{\text{m}}{\text{s}}$$

Transmitted particle velocity minus reflected particle velocity equals to the incident particle velocity, meaning that the second layer is in balance

Layer 3:

$$\sigma_{A3.I} := \sigma_{A2.T} = 0.696 \cdot \text{MPa}$$

Incident stress wave

$$\sigma_{A3.R} := \frac{\rho_{A4} \cdot c_A - \rho_{A3} \cdot c_A}{\rho_{A4} \cdot c_A + \rho_{A3} \cdot c_A} \cdot \sigma_{A3.I} = -0.043 \cdot \text{MPa}$$

Reflected stress wave, third layer in Rod A

$$\sigma_{A3.T} := \frac{2 \cdot \rho_{A4} \cdot c_A}{\rho_{A3} \cdot c_A + \rho_{A4} \cdot c_A} \cdot \sigma_{A3.I} = 0.653 \cdot \text{MPa}$$

Transmitted stress wave, third layer in Rod A

$$\sigma_{A3.T} - \sigma_{A3.R} = 0.696 \cdot \text{MPa}$$

Transmitted stress wave minus reflected stress wave equals to the initial stress wave, meaning that the third layer is in balance

$$U_{PI.A3} := \frac{\sigma_{A3.I}}{\rho_{A3} \cdot c_A} = 0.022 \frac{\text{m}}{\text{s}}$$

Incident particle velocity, third layer of Rod A

$$U_{PR.A3} := \frac{-\sigma_{A3.R}}{\rho_{A3} \cdot c_A} = 1.364 \times 10^{-3} \frac{m}{s}$$

Reflected particle velocity, third layer of Rod A

$$U_{PT.A3} := \frac{\sigma_{A3.T}}{\rho_{A4} \cdot c_A} = 0.023 \frac{m}{s}$$

Transmitted particle velocity, third layer of Rod A

$$U_{PT.A3} - U_{PR.A3} = 0.022 \frac{m}{s}$$

Transmitted particle velocity minus reflected particle velocity equals to the incident particle velocity, meaning that the third layer is in balance

Layer 4:

$$\sigma_{A4.I} := \sigma_{A3.T} = 0.653 \cdot \text{MPa}$$

Incident stress wave

$$\sigma_{A4.R} := \frac{\rho_{A5} \cdot c_A - \rho_{A4} \cdot c_A}{\rho_{A5} \cdot c_A + \rho_{A4} \cdot c_A} \cdot \sigma_{A4.I} = -0.046 \cdot \text{MPa}$$

Reflected stress wave, fourth layer in Rod A

$$\sigma_{A4.T} := \frac{2 \cdot \rho_{A5} \cdot c_A}{\rho_{A4} \cdot c_A + \rho_{A5} \cdot c_A} \cdot \sigma_{A4.I} = 0.608 \cdot \text{MPa}$$

Transmitted stress wave, fourth layer in Rod A

$$\sigma_{A4.T} - \sigma_{A4.R} = 0.653 \cdot \text{MPa}$$

Transmitted stress wave minus reflected stress wave equals to the initial stress wave, meaning that the fourth layer is in balance

$$U_{PI.A4} := \frac{\sigma_{A4.I}}{\rho_{A4} \cdot c_A} = 0.023 \frac{m}{s}$$

Incident particle velocity, fourth layer of Rod A

$$U_{PR.A4} := \frac{-\sigma_{A4.R}}{\rho_{A4} \cdot c_A} = 1.652 \times 10^{-3} \frac{m}{s}$$

Reflected particle velocity, fourth layer of Rod A

$$U_{PT.A4} := \frac{\sigma_{A4.T}}{\rho_{A5} \cdot c_A} = 0.025 \frac{m}{s}$$

Transmitted particle velocity, fourth layer of Rod A

$$U_{PT.A4} - U_{PR.A4} = 0.023 \frac{m}{s}$$

Transmitted particle velocity minus reflected particle velocity equals to the incident particle velocity, meaning that the fourth layer is in balance

Layer 5:

$$\sigma_{A5.I} := \sigma_{A4.T} = 0.608 \cdot \text{MPa}$$

Incident stress wave

$$\sigma_{A5.R} := \frac{\rho_{A6} \cdot c_A - \rho_{A5} \cdot c_A}{\rho_{A6} \cdot c_A + \rho_{A5} \cdot c_A} \cdot \sigma_{A5.I} = -0.05 \cdot \text{MPa}$$

Reflected stress wave, fifth layer in Rod A

$$\sigma_{A5.T} := \frac{2 \cdot \rho_{A6} \cdot c_A}{\rho_{A5} \cdot c_A + \rho_{A6} \cdot c_A} \cdot \sigma_{A5.I} = 0.558 \cdot \text{MPa}$$

Transmitted stress wave, fifth layer in Rod A

$$\sigma_{A5.T} - \sigma_{A5.R} = 0.608 \cdot \text{MPa}$$

Transmitted stress wave minus reflected stress wave equals to the initial stress wave, meaning that the fifth layer is in balance

$$U_{PI.A5} := \frac{\sigma_{A5.I}}{\rho_{A5} \cdot c_A} = 0.025 \frac{m}{s}$$

Incident particle velocity, fifth layer of Rod A

$$U_{PR.A5} := \frac{-\sigma_{A5.R}}{\rho_{A5} \cdot c_A} = 2.057 \times 10^{-3} \frac{m}{s}$$

Reflected particle velocity, fifth layer of Rod A

$$U_{PT.A5} := \frac{\sigma_{A5.T}}{\rho_{A6} \cdot c_A} = 0.027 \frac{m}{s}$$

Transmitted particle velocity, fifth layer of Rod A

$$U_{PT.A5} - U_{PR.A5} = 0.025 \frac{m}{s}$$

Transmitted particle velocity minus reflected particle velocity equals to the incident particle velocity, meaning that the fifth layer is in balance

Layer 6:

$$\sigma_{A6.I} := \sigma_{A5.T} = 0.558 \cdot \text{MPa}$$

Incident stress wave

$\sigma_{A6.R} := \frac{\rho_{A7} \cdot c_A - \rho_{A6} \cdot c_A}{\rho_{A7} \cdot c_A + \rho_{A6} \cdot c_A} \cdot \sigma_{A6.I} = -0.055 \cdot \text{MPa}$	Reflected stress wave, sixth layer in Rod A
$\sigma_{A6.T} := \frac{2 \cdot \rho_{A7} \cdot c_A}{\rho_{A6} \cdot c_A + \rho_{A7} \cdot c_A} \cdot \sigma_{A6.I} = 0.503 \cdot \text{MPa}$	Transmitted stress wave, sixth layer in Rod A
$\sigma_{A6.T} - \sigma_{A6.R} = 0.558 \cdot \text{MPa}$	Transmitted stress wave minus reflected stress wave equals to the initial stress wave, meaning that the sixth layer is in balance
$U_{PI.A6} := \frac{\sigma_{A6.I}}{\rho_{A6} \cdot c_A} = 0.027 \frac{\text{m}}{\text{s}}$	Incident particle velocity, sixth layer of Rod A
$U_{PR.A6} := \frac{-\sigma_{A6.R}}{\rho_{A6} \cdot c_A} = 2.661 \times 10^{-3} \frac{\text{m}}{\text{s}}$	Reflected particle velocity, sixth layer of Rod A
$U_{PT.A6} := \frac{\sigma_{A6.T}}{\rho_{A7} \cdot c_A} = 0.03 \frac{\text{m}}{\text{s}}$	Transmitted particle velocity, sixth layer of Rod A
$U_{PT.A6} - U_{PR.A6} = 0.027 \frac{\text{m}}{\text{s}}$	Transmitted particle velocity minus reflected particle velocity equals to the incident particle velocity, meaning that the sixth layer is in balance

Layer 7:

$\sigma_{A7.I} := \sigma_{A6.T} = 0.503 \cdot \text{MPa}$	Incident stress wave
$\sigma_{A7.R} := \frac{\rho_{A8} \cdot c_A - \rho_{A7} \cdot c_A}{\rho_{A8} \cdot c_A + \rho_{A7} \cdot c_A} \cdot \sigma_{A7.I} = -0.061 \cdot \text{MPa}$	Reflected stress wave, seventh layer in Rod A
$\sigma_{A7.T} := \frac{2 \cdot \rho_{A8} \cdot c_A}{\rho_{A7} \cdot c_A + \rho_{A8} \cdot c_A} \cdot \sigma_{A7.I} = 0.442 \cdot \text{MPa}$	Transmitted stress wave, seventh layer in Rod A

$$\sigma_{A7.T} - \sigma_{A7.R} = 0.503 \cdot \text{MPa}$$

Transmitted stress wave minus reflected stress wave equals to the initial stress wave, meaning that the seventh layer is in balance

$$U_{PI.A7} := \frac{\sigma_{A7.I}}{\rho_{A7} \cdot c_A} = 0.03 \frac{\text{m}}{\text{s}}$$

Incident particle velocity, seventh layer of Rod A

$$U_{PR.A7} := \frac{-\sigma_{A7.R}}{\rho_{A7} \cdot c_A} = 3.632 \times 10^{-3} \frac{\text{m}}{\text{s}}$$

Reflected particle velocity, seventh layer of Rod A

$$U_{PT.A7} := \frac{\sigma_{A7.T}}{\rho_{A8} \cdot c_A} = 0.033 \frac{\text{m}}{\text{s}}$$

Transmitted particle velocity, seventh layer of Rod A

$$U_{PT.A7} - U_{PR.A7} = 0.03 \frac{\text{m}}{\text{s}}$$

Transmitted particle velocity minus reflected particle velocity equals to the incident particle velocity, meaning that the seventh layer is in balance

Layer 8:

$$\sigma_{A8.I} := \sigma_{A7.T} = 0.442 \cdot \text{MPa}$$

Incident stress wave

$$\sigma_{A8.R} := \frac{\rho_{A9} \cdot c_A - \rho_{A8} \cdot c_A}{\rho_{A9} \cdot c_A + \rho_{A8} \cdot c_A} \cdot \sigma_{A8.I} = -0.071 \cdot \text{MPa}$$

Reflected stress wave, eighth layer in Rod A

$$\sigma_{A8.T} := \frac{2 \cdot \rho_{A9} \cdot c_A}{\rho_{A8} \cdot c_A + \rho_{A9} \cdot c_A} \cdot \sigma_{A8.I} = 0.371 \cdot \text{MPa}$$

Transmitted stress wave, eighth layer in Rod A

$$\sigma_{A8.T} - \sigma_{A8.R} = 0.442 \cdot \text{MPa}$$

Transmitted stress wave minus reflected stress wave equals to the initial stress wave, meaning that the eighth layer is in balance

$$U_{PI.A8} := \frac{\sigma_{A8.I}}{\rho_{A8} \cdot c_A} = 0.033 \frac{\text{m}}{\text{s}}$$

Incident particle velocity, eighth layer of Rod A

$$U_{PR.A8} := \frac{-\sigma_{A8.R}}{\rho_{A8} \cdot c_A} = 5.384 \times 10^{-3} \frac{m}{s}$$

Reflected particle velocity, eighth layer of Rod A

$$U_{PT.A8} := \frac{\sigma_{A8.T}}{\rho_{A9} \cdot c_A} = 0.039 \frac{m}{s}$$

Transmitted particle velocity, eighth layer of Rod A

$$U_{PT.A8} - U_{PR.A8} = 0.033 \frac{m}{s}$$

Transmitted particle velocity minus reflected particle velocity equals to the incident particle velocity, meaning that the eighth layer is in balance

Layer 9:

$$\sigma_{A9.I} := \sigma_{A8.T} = 0.371 \cdot \text{MPa}$$

Incident stress wave

$$\sigma_{A9.R} := \frac{\rho_{A10} \cdot c_A - \rho_{A9} \cdot c_A}{\rho_{A10} \cdot c_A + \rho_{A9} \cdot c_A} \cdot \sigma_{A9.I} = -0.088 \cdot \text{MPa}$$

Reflected stress wave, ninth layer in Rod A

$$\sigma_{A9.T} := \frac{2 \cdot \rho_{A10} \cdot c_A}{\rho_{A9} \cdot c_A + \rho_{A10} \cdot c_A} \cdot \sigma_{A9.I} = 0.283 \cdot \text{MPa}$$

Transmitted stress wave, ninth layer in Rod A

$$\sigma_{A9.T} - \sigma_{A9.R} = 0.371 \cdot \text{MPa}$$

Transmitted stress wave minus reflected stress wave equals to the initial stress wave, meaning that the ninth layer is in balance

$$U_{PI.A9} := \frac{\sigma_{A9.I}}{\rho_{A9} \cdot c_A} = 0.039 \frac{m}{s}$$

Incident particle velocity, ninth layer of Rod A

$$U_{PR.A9} := \frac{-\sigma_{A9.R}}{\rho_{A9} \cdot c_A} = 9.209 \times 10^{-3} \frac{m}{s}$$

Reflected particle velocity, ninth layer of Rod A

$$U_{PT.A9} := \frac{\sigma_{A9.T}}{\rho_{A10} \cdot c_A} = 0.048 \frac{m}{s}$$

Transmitted particle velocity, ninth layer of Rod A

$$U_{PT.A9} - U_{PR.A9} = 0.039 \frac{\text{m}}{\text{s}}$$

Transmitted particle velocity minus reflected particle velocity equals to the incident particle velocity, meaning that the ninth layer is in balance

Layer 10:

$$\sigma_{A10.I} := \sigma_{A9.T} = 0.283 \cdot \text{MPa}$$

Incident stress wave

$$\sigma_{A10.R} := \sigma_{A9.T} = 0.283 \cdot \text{MPa}$$

Reflected stress wave, tenth layer in Rod A

No transmitted stress wave in tenth layer

$$\sigma_{A10.I} + \sigma_{A10.R} = 0.566 \cdot \text{MPa}$$

Balance in the layer

$$U_{PI.A10} := \frac{\sigma_{A10.I}}{\rho_{A10} \cdot c_A} = 0.048 \frac{\text{m}}{\text{s}}$$

Incident particle velocity, tenth layer of Rod A

$$U_{PR.A10} := U_{PI.A10} = 0.048 \frac{\text{m}}{\text{s}}$$

Reflected particle velocity, tenth layer of Rod A

No transmitted stress wave in tenth layer

$$U_{PR.A10} - U_{PI.A10} = 0 \frac{\text{m}}{\text{s}}$$

Balance in the layer

Material parameters Rod B

Material parameters is calculated from Mathematica

Young's modulus:

$$E_{B1} := 1.8125 \cdot 10^{11} \cdot \text{Pa}$$

$$E_{B2} := 1.3329 \cdot 10^{11} \cdot \text{Pa}$$

$$E_{B3} := 9.6633 \cdot 10^{10} \cdot \text{Pa}$$

$$E_{B4} := 6.9587 \cdot 10^{10} \cdot \text{Pa}$$

$$E_{B5} := 5.0449 \cdot 10^{10} \cdot \text{Pa}$$

$$E_{B6} := 3.7515 \cdot 10^{10} \cdot \text{Pa}$$

$$E_{B7} := 2.9086 \cdot 10^{10} \cdot \text{Pa}$$

$$E_{B8} := 2.3461 \cdot 10^{10} \cdot \text{Pa}$$

$$E_{B9} := 1.8938 \cdot 10^{10} \cdot \text{Pa}$$

$$E_{B10} := 1.3817 \cdot 10^{10} \cdot \text{Pa}$$

Density:

$$\rho_{B1} := 8.2952 \cdot 10^3 \cdot \frac{\text{kg}}{\text{m}^3}$$

$$\rho_{B2} := 9.2542 \cdot 10^3 \cdot \frac{\text{kg}}{\text{m}^3}$$

$$\rho_{B3} := 1.0246 \cdot 10^4 \cdot \frac{\text{kg}}{\text{m}^3}$$

$$\rho_{B4} := 1.1116 \cdot 10^4 \cdot \frac{\text{kg}}{\text{m}^3}$$

$$\rho_{B5} := 1.1568 \cdot 10^4 \cdot \frac{\text{kg}}{\text{m}^3}$$

$$\rho_{B6} := 1.1206 \cdot 10^4 \cdot \frac{\text{kg}}{\text{m}^3}$$

$$\rho_{B7} := 9.7610 \cdot 10^3 \cdot \frac{\text{kg}}{\text{m}^3}$$

$$\rho_{B8} := 7.4218 \cdot 10^3 \cdot \frac{\text{kg}}{\text{m}^3}$$

$$\rho_{B9} := 4.8072 \cdot 10^3 \cdot \frac{\text{kg}}{\text{m}^3}$$

$$\rho_{B10} := 2.5085 \cdot 10^3 \cdot \frac{\text{kg}}{\text{m}^3}$$

Wave velocity:

$$c_{B1} := \sqrt{\frac{E_{B1}}{\rho_{B1}}} = 4.674 \times 10^3 \frac{\text{m}}{\text{s}}$$

$$c_{B2} := \sqrt{\frac{E_{B2}}{\rho_{B2}}} = 3.795 \times 10^3 \frac{\text{m}}{\text{s}}$$

$$c_{B3} := \sqrt{\frac{E_{B3}}{\rho_{B3}}} = 3.071 \times 10^3 \frac{\text{m}}{\text{s}}$$

$$c_{B4} := \sqrt{\frac{E_{B4}}{\rho_{B4}}} = 2.502 \times 10^3 \frac{\text{m}}{\text{s}}$$

$$c_{B5} := \sqrt{\frac{E_{B5}}{\rho_{B5}}} = 2.088 \times 10^3 \frac{\text{m}}{\text{s}}$$

$$c_{B6} := \sqrt{\frac{E_{B6}}{\rho_{B6}}} = 1.83 \times 10^3 \frac{\text{m}}{\text{s}}$$

$$c_{B7} := \sqrt{\frac{E_{B7}}{\rho_{B7}}} = 1.726 \times 10^3 \frac{\text{m}}{\text{s}}$$

$$c_{B8} := \sqrt{\frac{E_{B8}}{\rho_{B8}}} = 1.778 \times 10^3 \frac{\text{m}}{\text{s}}$$

$$c_{B9} := \sqrt{\frac{E_{B9}}{\rho_{B9}}} = 1.985 \times 10^3 \frac{\text{m}}{\text{s}}$$

$$c_{B10} := \sqrt{\frac{E_{B10}}{\rho_{B10}}} = 2.347 \times 10^3 \frac{\text{m}}{\text{s}}$$

Stresses Rod B

Layer 1:

$$\sigma_{B1.I} := \frac{F}{A} = 0.775 \cdot \text{MPa}$$

Initial stress wave of Rod A and B

$$\sigma_{B1.R} := \frac{\rho_{B2} \cdot c_{B2} - \rho_{B1} \cdot c_{B1}}{\rho_{B2} \cdot c_{B2} + \rho_{B1} \cdot c_{B1}} \cdot \sigma_{I1} = -0.038 \cdot \text{MPa}$$

Reflected stress wave, first layer in Rod B

$$\sigma_{B1.T} := \frac{2 \cdot \rho_{B2} \cdot c_{B2}}{\rho_{B1} \cdot c_{B1} + \rho_{B2} \cdot c_{B2}} \cdot \sigma_{I1} = 0.737 \cdot \text{MPa}$$

Transmitted stress wave, first layer in Rod B

$$\sigma_{B1.T} - \sigma_{A1.R} = 0.775 \cdot \text{MPa}$$

Transmitted stress wave minus reflected stress wave equals to the initial stress wave, meaning that the first layer is in balance

$$U_{PI.B1} := \frac{\sigma_{B1.I}}{\rho_{B1} \cdot c_{B1}} = 0.02 \frac{\text{m}}{\text{s}}$$

Initial particle velocity, first layer of Rod B

$$U_{PR.B1} := \frac{-\sigma_{B1.R}}{\rho_{B1} \cdot c_{B1}} = 9.885 \times 10^{-4} \frac{\text{m}}{\text{s}}$$

Reflected particle velocity, first layer of Rod B

$$U_{PT.B1} := \frac{\sigma_{B1.T}}{\rho_{B2} \cdot c_{B2}} = 0.021 \frac{\text{m}}{\text{s}}$$

Transmitted particle velocity, first layer of Rod B

$$U_{PT.B1} - U_{PR.B1} = 0.02 \frac{\text{m}}{\text{s}}$$

Transmitted particle velocity minus reflected particle velocity equals to the initial particle velocity, meaning that the first layer is in balance

Layer 2:

$$\sigma_{B2.I} := \sigma_{B1.T} = 0.737 \cdot \text{MPa} \quad \text{Incident stress wave}$$

$$\sigma_{B2.R} := \frac{\rho_{B3} \cdot c_{B3} - \rho_{B2} \cdot c_{B2}}{\rho_{B3} \cdot c_{B3} + \rho_{B2} \cdot c_{B2}} \cdot \sigma_{B2.I} = -0.04 \cdot \text{MPa} \quad \text{Reflected stress wave, second layer in Rod B}$$

$$\sigma_{B2.T} := \frac{2 \cdot \rho_{B3} \cdot c_{B3}}{\rho_{B2} \cdot c_{B2} + \rho_{B3} \cdot c_{B3}} \cdot \sigma_{B2.I} = 0.696 \cdot \text{MPa} \quad \text{Transmitted stress wave, second layer in Rod B}$$

$$\sigma_{B2.T} - \sigma_{B2.R} = 0.737 \cdot \text{MPa} \quad \text{Transmitted stress wave minus reflected stress wave equals to the initial stress wave, meaning that the second layer is in balance}$$

$$U_{PI.B2} := \frac{\sigma_{B2.I}}{\rho_{B2} \cdot c_{B2}} = 0.021 \frac{\text{m}}{\text{s}} \quad \text{Incident particle velocity, second layer of Rod B}$$

$$U_{PR.B2} := \frac{-\sigma_{B2.R}}{\rho_{B2} \cdot c_{B2}} = 1.152 \times 10^{-3} \frac{\text{m}}{\text{s}} \quad \text{Reflected particle velocity, second layer of Rod B}$$

$$U_{PT.B2} := \frac{\sigma_{B2.T}}{\rho_{B3} \cdot c_{B3}} = 0.022 \frac{\text{m}}{\text{s}} \quad \text{Transmitted particle velocity, second layer of Rod B}$$

$$U_{PT.B2} - U_{PR.B2} = 0.021 \frac{\text{m}}{\text{s}} \quad \text{Transmitted particle velocity minus reflected particle velocity equals to the incident particle velocity, meaning that the second layer is in balance}$$

Layer 3:

$$\sigma_{B3.I} := \sigma_{B2.T} = 0.696 \cdot \text{MPa} \quad \text{Incident stress wave}$$

$$\sigma_{B3.R} := \frac{\rho_{B4} \cdot c_{B4} - \rho_{B3} \cdot c_{B3}}{\rho_{B4} \cdot c_{B4} + \rho_{B3} \cdot c_{B3}} \cdot \sigma_{B3.I} = -0.043 \cdot \text{MPa} \quad \text{Reflected stress wave, third layer in Rod B}$$

$$\sigma_{B3.T} := \frac{2 \cdot \rho_{B4} \cdot c_{B4}}{\rho_{B3} \cdot c_{B3} + \rho_{B4} \cdot c_{B4}} \cdot \sigma_{B3.I} = 0.653 \cdot \text{MPa}$$

Transmitted stress wave, third layer in Rod B

$$\sigma_{B3.T} - \sigma_{B3.R} = 0.696 \cdot \text{MPa}$$

Transmitted stress wave minus reflected stress wave equals to the initial stress wave, meaning that the third layer is in balance

$$U_{PI.B3} := \frac{\sigma_{B3.I}}{\rho_{B3} \cdot c_{B3}} = 0.022 \frac{\text{m}}{\text{s}}$$

Incident particle velocity, third layer of Rod B

$$U_{PR.B3} := \frac{-\sigma_{B3.R}}{\rho_{B3} \cdot c_{B3}} = 1.364 \times 10^{-3} \frac{\text{m}}{\text{s}}$$

Reflected particle velocity, third layer of Rod B

$$U_{PT.B3} := \frac{\sigma_{B3.T}}{\rho_{B4} \cdot c_{B4}} = 0.023 \frac{\text{m}}{\text{s}}$$

Transmitted particle velocity, third layer of Rod B

$$U_{PT.B3} - U_{PR.B3} = 0.022 \frac{\text{m}}{\text{s}}$$

Transmitted particle velocity minus reflected particle velocity equals to the incident particle velocity, meaning that the third layer is in balance

Layer 4:

$$\sigma_{B4.I} := \sigma_{B3.T} = 0.653 \cdot \text{MPa}$$

Incident stress wave

$$\sigma_{B4.R} := \frac{\rho_{B5} \cdot c_{B5} - \rho_{B4} \cdot c_{B4}}{\rho_{B5} \cdot c_{B5} + \rho_{B4} \cdot c_{B4}} \cdot \sigma_{B4.I} = -0.046 \cdot \text{MPa}$$

Reflected stress wave, fourth layer in Rod B

$$\sigma_{B4.T} := \frac{2 \cdot \rho_{B5} \cdot c_{B5}}{\rho_{B4} \cdot c_{B4} + \rho_{B5} \cdot c_{B5}} \cdot \sigma_{B4.I} = 0.608 \cdot \text{MPa}$$

Transmitted stress wave, fourth layer in Rod B

$$\sigma_{B4.T} - \sigma_{B4.R} = 0.653 \cdot \text{MPa}$$

Transmitted stress wave minus reflected stress wave equals to the initial stress wave, meaning that the fourth layer is in balance

$$U_{PI.B4} := \frac{\sigma_{B4.I}}{\rho_{B4} \cdot c_{B4}} = 0.023 \frac{\text{m}}{\text{s}}$$

Incident particle velocity, fourth layer of Rod B

$$U_{PR.B4} := \frac{-\sigma_{B4.R}}{\rho_{B4} \cdot c_{B4}} = 1.652 \times 10^{-3} \frac{m}{s}$$

Reflected particle velocity, fourth layer of Rod B

$$U_{PT.B4} := \frac{\sigma_{B4.T}}{\rho_{B5} \cdot c_{B5}} = 0.025 \frac{m}{s}$$

Transmitted particle velocity, fourth layer of Rod B

$$U_{PT.B4} - U_{PR.B4} = 0.023 \frac{m}{s}$$

Transmitted particle velocity minus reflected particle velocity equals to the incident particle velocity, meaning that the fourth layer is in balance

Layer 5:

$$\sigma_{B5.I} := \sigma_{B4.T} = 0.608 \cdot \text{MPa}$$

Incident stress wave

$$\sigma_{B5.R} := \frac{\rho_{B6} \cdot c_{B6} - \rho_{B5} \cdot c_{B5}}{\rho_{B6} \cdot c_{B6} + \rho_{B5} \cdot c_{B5}} \cdot \sigma_{B5.I} = -0.05 \cdot \text{MPa}$$

Reflected stress wave, fifth layer in Rod B

$$\sigma_{B5.T} := \frac{2 \cdot \rho_{B6} \cdot c_{B6}}{\rho_{B5} \cdot c_{B5} + \rho_{B6} \cdot c_{B6}} \cdot \sigma_{B5.I} = 0.558 \cdot \text{MPa}$$

Transmitted stress wave, fifth layer in Rod B

$$\sigma_{B5.T} - \sigma_{B5.R} = 0.608 \cdot \text{MPa}$$

Transmitted stress wave minus reflected stress wave equals to the initial stress wave, meaning that the fifth layer is in balance

$$U_{PI.B5} := \frac{\sigma_{B5.I}}{\rho_{B5} \cdot c_{B5}} = 0.025 \frac{m}{s}$$

Incident particle velocity, fifth layer of Rod B

$$U_{PR.B5} := \frac{-\sigma_{B5.R}}{\rho_{B5} \cdot c_{B5}} = 2.058 \times 10^{-3} \frac{m}{s}$$

Reflected particle velocity, fifth layer of Rod B

$$U_{PT.B5} := \frac{\sigma_{B5.T}}{\rho_{B6} \cdot c_{B6}} = 0.027 \frac{m}{s}$$

Transmitted particle velocity, fifth layer of Rod B

$$U_{PT.B5} - U_{PR.B5} = 0.025 \frac{\text{m}}{\text{s}}$$

Transmitted particle velocity minus reflected particle velocity equals to the incident particle velocity, meaning that the fifth layer is in balance

Layer 6:

$$\sigma_{B6.I} := \sigma_{B5.T} = 0.558 \cdot \text{MPa}$$

Incident stress wave

$$\sigma_{B6.R} := \frac{\rho_{B7} \cdot c_{B7} - \rho_{B6} \cdot c_{B6}}{\rho_{B7} \cdot c_{B7} + \rho_{B6} \cdot c_{B6}} \cdot \sigma_{B6.I} = -0.055 \cdot \text{MPa}$$

Reflected stress wave, sixth layer in Rod B

$$\sigma_{B6.T} := \frac{2 \cdot \rho_{B7} \cdot c_{B7}}{\rho_{B6} \cdot c_{B6} + \rho_{B7} \cdot c_{B7}} \cdot \sigma_{B6.I} = 0.503 \cdot \text{MPa}$$

Transmitted stress wave, sixth layer in Rod B

$$\sigma_{B6.T} - \sigma_{B6.R} = 0.558 \cdot \text{MPa}$$

Transmitted stress wave minus reflected stress wave equals to the initial stress wave, meaning that the sixth layer is in balance

$$U_{PI.B6} := \frac{\sigma_{B6.I}}{\rho_{B6} \cdot c_{B6}} = 0.027 \frac{\text{m}}{\text{s}}$$

Incident particle velocity, sixth layer of Rod B

$$U_{PR.B6} := \frac{-\sigma_{B6.R}}{\rho_{B6} \cdot c_{B6}} = 2.661 \times 10^{-3} \frac{\text{m}}{\text{s}}$$

Reflected particle velocity, sixth layer of Rod B

$$U_{PT.B6} := \frac{\sigma_{B6.T}}{\rho_{B7} \cdot c_{B7}} = 0.03 \frac{\text{m}}{\text{s}}$$

Transmitted particle velocity, sixth layer of Rod B

$$U_{PT.B6} - U_{PR.B6} = 0.027 \frac{\text{m}}{\text{s}}$$

Transmitted particle velocity minus reflected particle velocity equals to the incident particle velocity, meaning that the sixth layer is in balance

Layer 7:

$$\sigma_{B7.I} := \sigma_{B6.T} = 0.503 \cdot \text{MPa} \quad \text{Incident stress wave}$$

$$\sigma_{B7.R} := \frac{\rho_{B8} \cdot c_{B8} - \rho_{B7} \cdot c_{B7}}{\rho_{B8} \cdot c_{B8} + \rho_{B7} \cdot c_{B7}} \cdot \sigma_{B7.I} = -0.061 \cdot \text{MPa} \quad \text{Reflected stress wave, seventh layer in Rod B}$$

$$\sigma_{B7.T} := \frac{2 \cdot \rho_{B8} \cdot c_{B8}}{\rho_{B7} \cdot c_{B7} + \rho_{B8} \cdot c_{B8}} \cdot \sigma_{B7.I} = 0.442 \cdot \text{MPa} \quad \text{Transmitted stress wave, seventh layer in Rod B}$$

$$\sigma_{B7.T} - \sigma_{B7.R} = 0.503 \cdot \text{MPa} \quad \text{Transmitted stress wave minus reflected stress wave equals to the initial stress wave, meaning that the seventh layer is in balance}$$

$$U_{PI.B7} := \frac{\sigma_{B7.I}}{\rho_{B7} \cdot c_{B7}} = 0.03 \frac{\text{m}}{\text{s}} \quad \text{Incident particle velocity, seventh layer of Rod B}$$

$$U_{PR.B7} := \frac{-\sigma_{B7.R}}{\rho_{B7} \cdot c_{B7}} = 3.632 \times 10^{-3} \frac{\text{m}}{\text{s}} \quad \text{Reflected particle velocity, seventh layer of Rod B}$$

$$U_{PT.B7} := \frac{\sigma_{B7.T}}{\rho_{B8} \cdot c_{B8}} = 0.034 \frac{\text{m}}{\text{s}} \quad \text{Transmitted particle velocity, seventh layer of Rod B}$$

$$U_{PT.B7} - U_{PR.B7} = 0.03 \frac{\text{m}}{\text{s}} \quad \text{Transmitted particle velocity minus reflected particle velocity equals to the incident particle velocity, meaning that the seventh layer is in balance}$$

Layer 8:

$$\sigma_{B8.I} := \sigma_{B7.T} = 0.442 \cdot \text{MPa} \quad \text{Incident stress wave}$$

$$\sigma_{B8.R} := \frac{\rho_{B9} \cdot c_{B9} - \rho_{B8} \cdot c_{B8}}{\rho_{B9} \cdot c_{B9} + \rho_{B8} \cdot c_{B8}} \cdot \sigma_{B8.I} = -0.071 \cdot \text{MPa} \quad \text{Reflected stress wave, eighth layer in Rod B}$$

$$\sigma_{B8.T} := \frac{2 \cdot \rho_{B9} \cdot c_{B9}}{\rho_{B8} \cdot c_{B8} + \rho_{B9} \cdot c_{B9}} \cdot \sigma_{B8.I} = 0.371 \cdot \text{MPa}$$

Transmitted stress wave, eighth layer in Rod B

$$\sigma_{B8.T} - \sigma_{B8.R} = 0.442 \cdot \text{MPa}$$

Transmitted stress wave minus reflected stress wave equals to the initial stress wave, meaning that the eighth layer is in balance

$$U_{PI.B8} := \frac{\sigma_{B8.I}}{\rho_{B8} \cdot c_{B8}} = 0.034 \frac{\text{m}}{\text{s}}$$

Incident particle velocity, eighth layer of Rod B

$$U_{PR.B8} := \frac{-\sigma_{B8.R}}{\rho_{B8} \cdot c_{B8}} = 5.384 \times 10^{-3} \frac{\text{m}}{\text{s}}$$

Reflected particle velocity, eighth layer of Rod B

$$U_{PT.B8} := \frac{\sigma_{B8.T}}{\rho_{B9} \cdot c_{B9}} = 0.039 \frac{\text{m}}{\text{s}}$$

Transmitted particle velocity, eighth layer of Rod B

$$U_{PT.B8} - U_{PR.B8} = 0.034 \frac{\text{m}}{\text{s}}$$

Transmitted particle velocity minus reflected particle velocity equals to the incident particle velocity, meaning that the eighth layer is in balance

Layer 9:

$$\sigma_{B9.I} := \sigma_{B8.T} = 0.371 \cdot \text{MPa}$$

Incident stress wave

$$\sigma_{B9.R} := \frac{\rho_{B10} \cdot c_{B10} - \rho_{B9} \cdot c_{B9}}{\rho_{B10} \cdot c_{B10} + \rho_{B9} \cdot c_{B9}} \cdot \sigma_{B9.I} = -0.088 \cdot \text{MPa}$$

Reflected stress wave, ninth layer in Rod B

$$\sigma_{B9.T} := \frac{2 \cdot \rho_{B10} \cdot c_{B10}}{\rho_{B9} \cdot c_{B9} + \rho_{B10} \cdot c_{B10}} \cdot \sigma_{B9.I} = 0.283 \cdot \text{MPa}$$

Transmitted stress wave, ninth layer in Rod B

$$\sigma_{B9.T} - \sigma_{B9.R} = 0.371 \cdot \text{MPa}$$

Transmitted stress wave minus reflected stress wave equals to the initial stress wave, meaning that the ninth layer is in balance

$$U_{PI.B9} := \frac{\sigma_{B9.I}}{\rho_{B9} \cdot c_{B9}} = 0.039 \frac{m}{s}$$

Incident particle velocity, eighth layer of Rod B

$$U_{PR.B9} := \frac{-\sigma_{B9.R}}{\rho_{B9} \cdot c_{B9}} = 9.209 \times 10^{-3} \frac{m}{s}$$

Reflected particle velocity, eighth layer of Rod B

$$U_{PT.B9} := \frac{\sigma_{B9.T}}{\rho_{B10} \cdot c_{B10}} = 0.048 \frac{m}{s}$$

Transmitted particle velocity, eighth layer of Rod B

$$U_{PT.B9} - U_{PR.B9} = 0.039 \frac{m}{s}$$

Transmitted particle velocity minus reflected particle velocity equals to the incident particle velocity, meaning that the eighth layer is in balance

Layer 10:

$$\sigma_{B10.I} := \sigma_{B9.T} = 0.283 \cdot \text{MPa}$$

Incident stress wave

$$\sigma_{B10.R} := \sigma_{B9.T} = 0.283 \cdot \text{MPa}$$

Reflected stress wave, tenth layer in Rod A

No transmitted stress wave in tenth layer

$$\sigma_{B10.I} + \sigma_{B10.R} = 0.566 \cdot \text{MPa}$$

Balance in the layer

$$U_{PI.B10} := \frac{\sigma_{B10.I}}{\rho_{B10} \cdot c_{B10}} = 0.048 \frac{m}{s}$$

Incident particle velocity, tenth layer of Rod B

$$U_{PR.B10} := U_{PI.B10} = 0.048 \frac{m}{s}$$

Reflected particle velocity, tenth layer of Rod B

No transmitted stress wave in tenth layer

$$U_{PR.B10} - U_{PI.B10} = 0 \frac{m}{s}$$

Balance in the layer

E Material properties and dynamic response calculations, Case study 5

Calculation of material parameters for case studie five, linear psi function, and plots

Defines the psi functions and calculating beta(x)

$$\text{poly}[x_] := \frac{0.5}{1} * x$$

$$\text{Solve}\left[\frac{0.5}{1} * x == y, x\right]$$

$$\{\{x \rightarrow 2. y\}\}$$

$$\text{invpoly}[x_] := 2 x$$

$$\psi = \text{poly}$$

$$\text{poly}$$

$$\psi\text{inv} = \text{invpoly}$$

$$\text{invpoly}$$

$$\beta[x_] := \psi'[\psi\text{inv}[x]]$$

Defines the material functions for Young' s modulus and the density

$$\text{Emod}[x_] := (-3.750621271678328 * x^3 + 8.943324468199307 * x^2 - 7.607022512121505 * x + 2.443049644284467) * 10^{11}$$

$$\rho[x_] := (-1.402017951555948 * x^3 + 3.343099860731649 * x^2 - 2.843577462864469 * x + 0.913235224173003) * 10^4$$

Plots the different material curves for the material properties and the wave velocity

```
emod = Plot[Emod[x], {x, 0, 1}, PlotStyle -> GrayLevel[0],  
  AxesOrigin -> {0, 0}, AxesLabel -> {m, Pa}, LabelStyle -> {Black}]
```

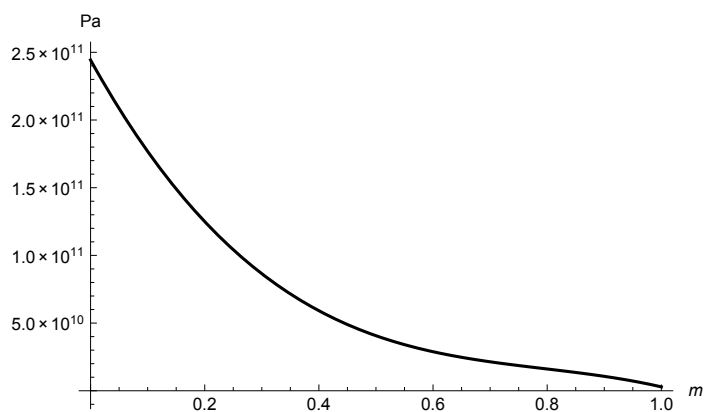

```
rho = Plot[ρ[x], {x, 0, 1}, PlotStyle → GrayLevel[0], AxesOrigin → {0, 0},
  AxesLabel → {m, kg / m^3}, LabelStyle → {Black}, PlotRange → {12000, 0}]
```

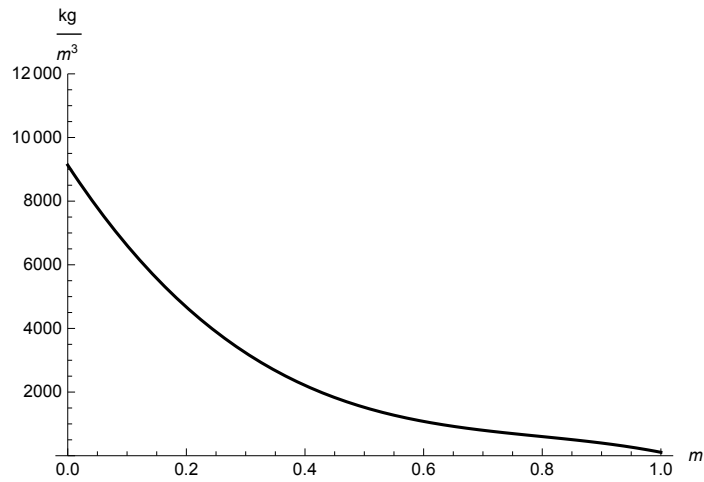

```
Plot[β[x], {x, 0, 1}, PlotStyle → GrayLevel[0], AxesOrigin → {0, 0}]
```

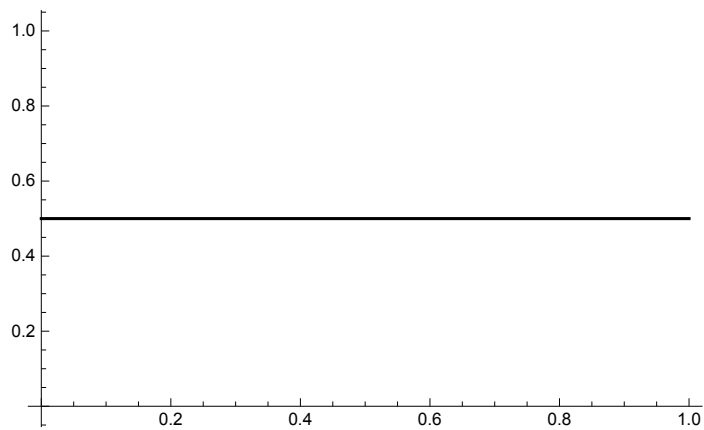

```
ehat = Plot[Emod[ψinv[x]] β[x], {x, 0, 0.5},
  PlotStyle → GrayLevel[0], AxesOrigin → {0, 0}]
```

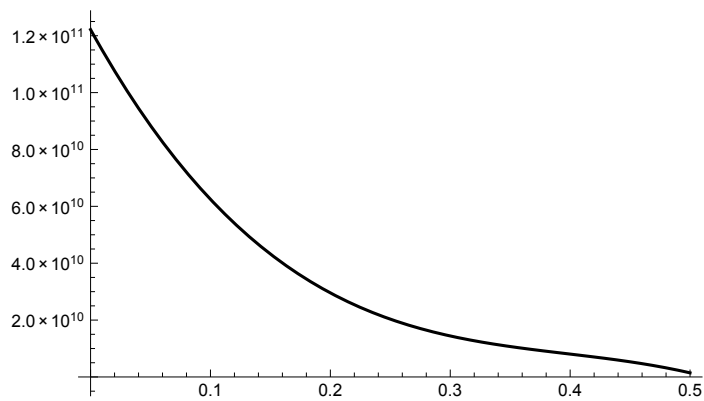

rhoHar =

```
Plot[ $\frac{\rho[\psi\text{inv}[\mathbf{x}]]}{\beta[\mathbf{x}]}$ , {x, 0, 0.5}, PlotStyle -> GrayLevel[0], AxesOrigin -> {0, 0}]
```

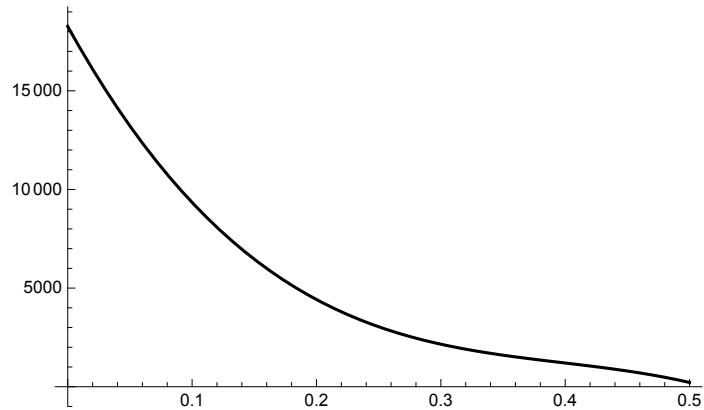

```
vel1 = Plot[ $\sqrt{\frac{\text{Emod}[\mathbf{x}]}{\rho[\mathbf{x}]}}$ , {x, 0, 1}, PlotStyle -> GrayLevel[0],  
AxesOrigin -> {0, 0}, AxesLabel -> {m, m / s}, LabelStyle -> {Black}]
```

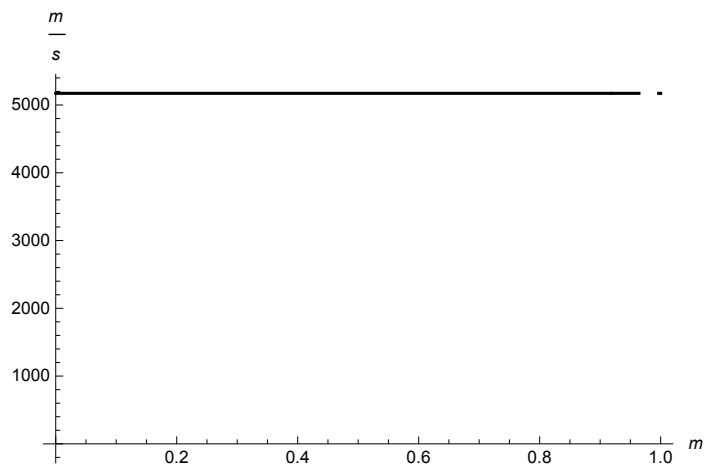

```
vel2 = Plot[ $\sqrt{\frac{\text{Emod}[\psi\text{inv}[\mathbf{x}]] \beta[\mathbf{x}]}{\frac{\rho[\psi\text{inv}[\mathbf{x}]]}{\beta[\mathbf{x}]}}}$ ,  
{x, 0, 0.5}, PlotStyle -> GrayLevel[0], AxesOrigin -> {0, 0}]
```

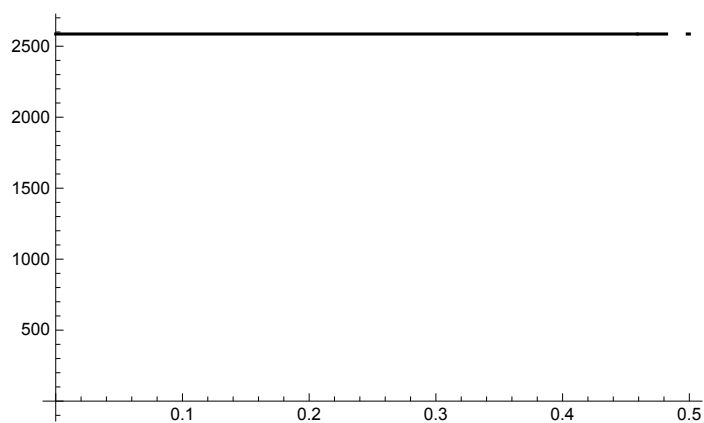

Plot[ψ inv[x], {x, 0, 1}, AxesOrigin \rightarrow {0, 0}]

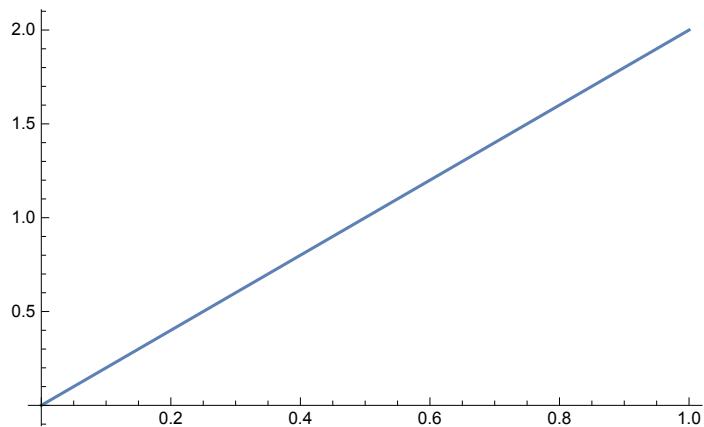

Calculating the material properties from the curves for the transformed and original rods and where the reflections occur

MatrixForm[**Table**[

$$\left\{ \mathbf{x}, \mathbf{x} + 0.05, \mathbf{Emod}[\mathbf{x}], \rho[\mathbf{x}], \mathbf{Emod}[\mathbf{x}] \rho[\mathbf{x}], \sqrt{\frac{\mathbf{Emod}[\mathbf{x}]}{\rho[\mathbf{x}]}} \right\}, \left\{ \mathbf{x}, \frac{0.1}{2}, 1 - \frac{0.1}{2}, 0.1 \right\} \right]$$

0.05	0.1	2.08459×10^{11}	7792.39	1.62439×10^{15}	5172.19
0.15	0.2	1.49056×10^{11}	5571.87	8.30521×10^{14}	5172.19
0.25	0.3	1.04165×10^{11}	3893.78	4.05595×10^{14}	5172.19
0.35	0.4	7.15341×10^{10}	2674.01	1.91283×10^{14}	5172.19
0.45	0.5	4.89137×10^{10}	1828.44	8.94359×10^{13}	5172.19
0.55	0.6	3.40533×10^{10}	1272.95	4.3348×10^{13}	5172.19
0.65	0.7	2.47025×10^{10}	923.404	2.28104×10^{13}	5172.19
0.75	0.8	1.86109×10^{10}	695.695	1.29475×10^{13}	5172.19
0.85	0.9	1.35282×10^{10}	505.698	6.84119×10^{12}	5172.19
0.95	1.	7.20397×10^9	269.291	1.93996×10^{12}	5172.19

MatrixForm[**Table**[{ $\mathbf{x}, \psi[\mathbf{x}], \beta[\psi[\mathbf{x}]] \mathbf{Emod}[\psi$ inv[$\psi[\mathbf{x}]]],$
 $\frac{\rho[\psi$ inv[$\psi[\mathbf{x}]]]}{\beta[\psi[\mathbf{x}]]}, \beta[\psi[\mathbf{x}]] \mathbf{Emod}[\psi$ inv[$\psi[\mathbf{x}]]] \frac{\rho[\psi$ inv[$\psi[\mathbf{x}]]]}{\beta[\psi[\mathbf{x}]]},$
 $\sqrt{\frac{\beta[\psi[\mathbf{x}]] \mathbf{Emod}[\psi$ inv[$\psi[\mathbf{x}]]]}{\frac{\rho[\psi$ inv[$\psi[\mathbf{x}]]}{\beta[\psi[\mathbf{x}]]}}}$ }, { $\mathbf{x}, \frac{0.1}{2}, 1 - \frac{0.1}{2}, 0.1$ }]]]

0.05	0.025	1.04229×10^{11}	15584.8	1.62439×10^{15}	2586.1
0.15	0.075	7.45281×10^{10}	11143.7	8.30521×10^{14}	2586.1
0.25	0.125	5.20824×10^{10}	7787.56	4.05595×10^{14}	2586.1
0.35	0.175	3.57671×10^{10}	5348.03	1.91283×10^{14}	2586.1
0.45	0.225	2.44569×10^{10}	3656.88	8.94359×10^{13}	2586.1
0.55	0.275	1.70267×10^{10}	2545.89	4.3348×10^{13}	2586.1
0.65	0.325	1.23513×10^{10}	1846.81	2.28104×10^{13}	2586.1
0.75	0.375	9.30547×10^9	1391.39	1.29475×10^{13}	2586.1
0.85	0.425	6.76411×10^9	1011.4	6.84119×10^{12}	2586.1
0.95	0.475	3.60198×10^9	538.582	1.93996×10^{12}	2586.1

Plotting the final plots which shows the transformed and original values for Young's modulus the density and the wave velocity

`emodul = Show[emod, ehat]`

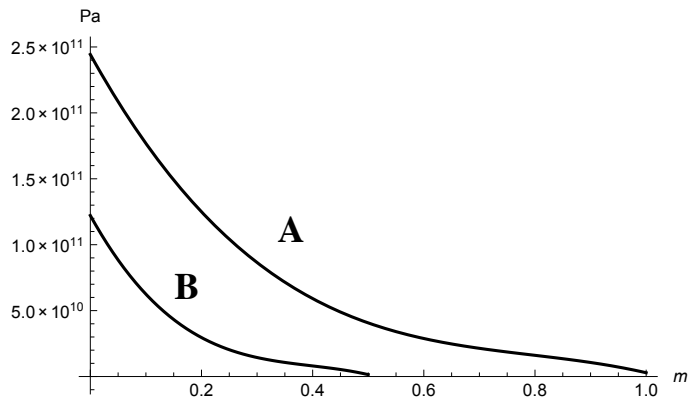

`density = Show[rho, rhohar]`

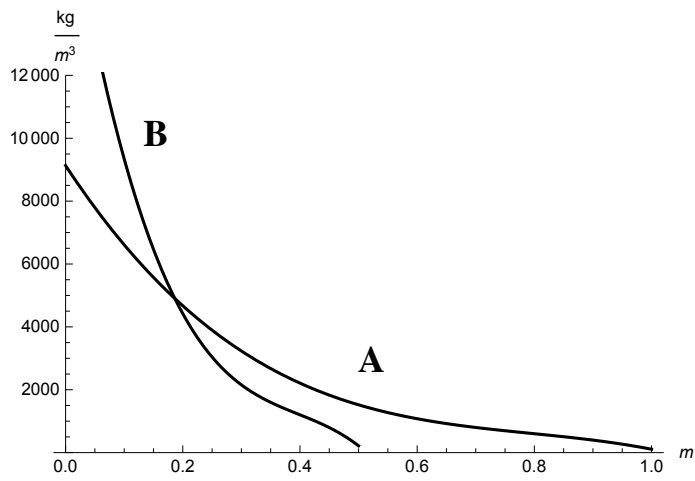

`velocity = Show[vel1, vel2]`

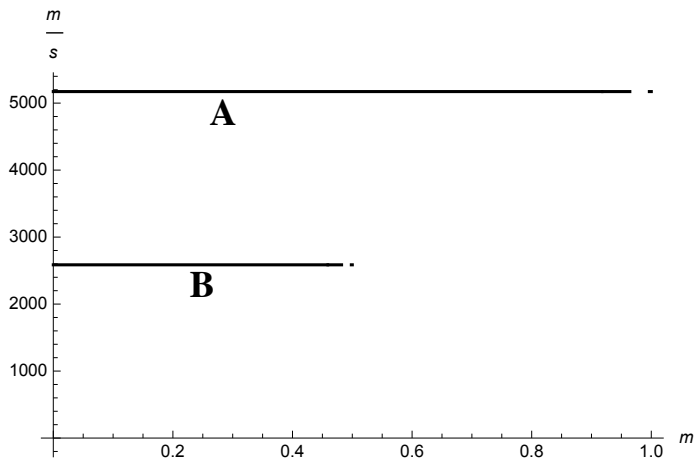

Transformation with x-function (linear), Case Study 5

Following calculations are made with the theory of elastic wave propagation between different materials. This is done in order to compare two Rods (A and B) with different lengths and material parameters. Stresses and particle velocity for incident, reflected and transmitted waves will be determine and presented below.

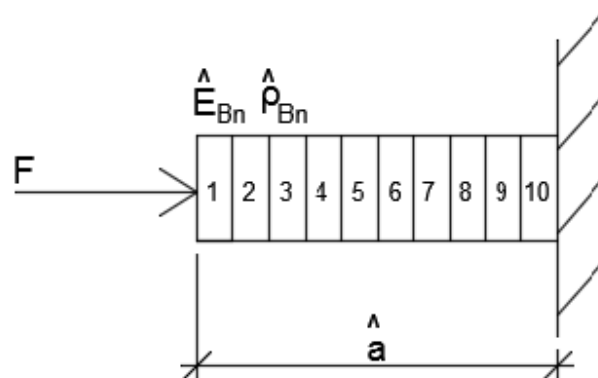
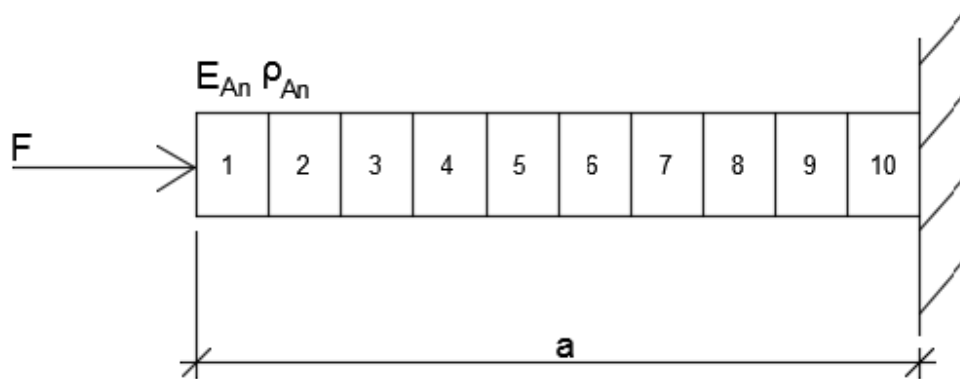

Material parameters Rod A

Material parameters has been calculated in mathematica

Young's modulus:

Density:

Wave velocity:

$$E_{A1} := 2.08459 \cdot 10^{11} \cdot \text{Pa}$$

$$\rho_{A1} := 7792.39 \cdot \frac{\text{kg}}{\text{m}^3}$$

$$c_{A1} := \sqrt{\frac{E_{A1}}{\rho_{A1}}} = 5.172 \times 10^3 \frac{\text{m}}{\text{s}}$$

$$E_{A2} := 1.49056 \cdot 10^{11} \cdot \text{Pa}$$

$$\rho_{A2} := 5571.87 \cdot \frac{\text{kg}}{\text{m}^3}$$

$$c_{A2} := \sqrt{\frac{E_{A2}}{\rho_{A2}}} = 5.172 \times 10^3 \frac{\text{m}}{\text{s}}$$

$$E_{A3} := 1.04165 \cdot 10^{11} \cdot \text{Pa}$$

$$\rho_{A3} := 3893.78 \cdot \frac{\text{kg}}{\text{m}^3}$$

$$c_{A3} := \sqrt{\frac{E_{A3}}{\rho_{A3}}} = 5.172 \times 10^3 \frac{\text{m}}{\text{s}}$$

$E_{A4} := 7.15341 \cdot 10^{10} \cdot \text{Pa}$	$\rho_{A4} := 2674.01 \cdot \frac{\text{kg}}{\text{m}^3}$	$c_{A4} := \sqrt{\frac{E_{A4}}{\rho_{A4}}} = 5.172 \times 10^3 \frac{\text{m}}{\text{s}}$
$E_{A5} := 4.89137 \cdot 10^{10} \cdot \text{Pa}$	$\rho_{A5} := 1828.44 \cdot \frac{\text{kg}}{\text{m}^3}$	$c_{A5} := \sqrt{\frac{E_{A5}}{\rho_{A5}}} = 5.172 \times 10^3 \frac{\text{m}}{\text{s}}$
$E_{A6} := 3.40533 \cdot 10^{10} \cdot \text{Pa}$	$\rho_{A6} := 1272.95 \cdot \frac{\text{kg}}{\text{m}^3}$	$c_{A6} := \sqrt{\frac{E_{A6}}{\rho_{A6}}} = 5.172 \times 10^3 \frac{\text{m}}{\text{s}}$
$E_{A7} := 2.47025 \cdot 10^{10} \cdot \text{Pa}$	$\rho_{A7} := 923.404 \cdot \frac{\text{kg}}{\text{m}^3}$	$c_{A7} := \sqrt{\frac{E_{A7}}{\rho_{A7}}} = 5.172 \times 10^3 \frac{\text{m}}{\text{s}}$
$E_{A8} := 1.86109 \cdot 10^{10} \cdot \text{Pa}$	$\rho_{A8} := 695.695 \cdot \frac{\text{kg}}{\text{m}^3}$	$c_{A8} := \sqrt{\frac{E_{A8}}{\rho_{A8}}} = 5.172 \times 10^3 \frac{\text{m}}{\text{s}}$
$E_{A9} := 1.35282 \cdot 10^{10} \cdot \text{Pa}$	$\rho_{A9} := 505.698 \cdot \frac{\text{kg}}{\text{m}^3}$	$c_{A9} := \sqrt{\frac{E_{A9}}{\rho_{A9}}} = 5.172 \times 10^3 \frac{\text{m}}{\text{s}}$
$E_{A10} := 7.20397 \cdot 10^9 \cdot \text{Pa}$	$\rho_{A10} := 269.291 \cdot \frac{\text{kg}}{\text{m}^3}$	$c_{A10} := \sqrt{\frac{E_{A10}}{\rho_{A10}}} = 5.172 \times 10^3 \frac{\text{m}}{\text{s}}$

Wave Velocity:

$$c_A := \sqrt{\frac{E_{A1}}{\rho_{A1}}} = 5.172 \times 10^3 \frac{\text{m}}{\text{s}}$$

Stresses in Rod A

$$F := 500\text{N}$$

Force at the left end of the Rod A and B

$$A := 6.450 \cdot 10^{-4} \text{m}^2$$

Cross section area of Rod A and B

Layer 1:

$$\sigma_{I1} := \frac{F}{A} = 0.775 \cdot \text{MPa}$$

Initial stress wave of Rod A and B

$$\sigma_{A1.R} := \frac{\rho_{A2} \cdot c_{A2} - \rho_{A1} \cdot c_{A1}}{\rho_{A2} \cdot c_{A2} + \rho_{A1} \cdot c_{A1}} \cdot \sigma_{I1} = -0.129 \cdot \text{MPa}$$

Reflected stress wave, first layer in Rod A

$$\sigma_{A1.T} := \frac{2 \cdot \rho_{A2} \cdot c_{A2}}{\rho_{A1} \cdot c_{A1} + \rho_{A2} \cdot c_{A2}} \cdot \sigma_{I1} = 0.646 \cdot \text{MPa}$$

Transmitted stress wave, first layer in Rod A

$$\sigma_{A1.T} - \sigma_{A1.R} = 0.775 \cdot \text{MPa}$$

Transmitted stress wave minus reflected stress wave equals to the initial stress wave, meaning that the first layer is in balance

$$U_{PI.A1} := \frac{\sigma_{I1}}{\rho_{A1} \cdot c_{A1}} = 0.019 \frac{\text{m}}{\text{s}}$$

Initial particle velocity, first layer of Rod A

$$U_{PR.A1} := \frac{-\sigma_{A1.R}}{\rho_{A1} \cdot c_{A1}} = 3.196 \times 10^{-3} \frac{\text{m}}{\text{s}}$$

Reflected particle velocity, first layer of Rod A

$$U_{PT.A1} := \frac{\sigma_{A1.T}}{\rho_{A2} \cdot c_{A2}} = 0.022 \frac{\text{m}}{\text{s}}$$

Transmitted particle velocity, first layer of Rod A

$$U_{PT.A1} - U_{PR.A1} = 0.019 \frac{\text{m}}{\text{s}}$$

Transmitted particle velocity minus reflected particle velocity equals to the initial particle velocity, meaning that the first layer is in balance

Layer 2:

$$\sigma_{A2.I} := \sigma_{A1.T} = 0.646 \cdot \text{MPa}$$

Incident stress wave

$$\sigma_{A2.R} := \frac{\rho_{A3} \cdot c_{A3} - \rho_{A2} \cdot c_{A2}}{\rho_{A3} \cdot c_{A3} + \rho_{A2} \cdot c_{A2}} \cdot \sigma_{A2.I} = -0.115 \cdot \text{MPa}$$

Reflected stress wave, second layer in Rod A

$$\sigma_{A2.T} := \frac{2 \cdot \rho_{A3} \cdot c_{A3}}{\rho_{A2} \cdot c_{A2} + \rho_{A3} \cdot c_{A3}} \cdot \sigma_{A2.I} = 0.532 \cdot \text{MPa}$$

Transmitted stress wave, second layer in Rod A

$$\sigma_{A2.T} - \sigma_{A2.R} = 0.646 \cdot \text{MPa}$$

Transmitted stress wave minus reflected stress wave equals to the incident stress wave, meaning that the second layer is in balance

$$U_{PI.A2} := \frac{\sigma_{A2.I}}{\rho_{A2} \cdot c_{A2}} = 0.022 \frac{\text{m}}{\text{s}}$$

Incident particle velocity, second second of Rod A

$$U_{PR.A2} := \frac{-\sigma_{A2.R}}{\rho_{A2} \cdot c_{A2}} = 3.976 \times 10^{-3} \frac{\text{m}}{\text{s}}$$

Reflected particle velocity, second layer of Rod A

$$U_{PT.A2} := \frac{\sigma_{A2.T}}{\rho_{A3} \cdot c_{A3}} = 0.026 \frac{\text{m}}{\text{s}}$$

Transmitted particle velocity, second layer of Rod A

$$U_{PT.A2} - U_{PR.A2} = 0.022 \frac{\text{m}}{\text{s}}$$

Transmitted particle velocity minus reflected particle velocity equals to the incident particle velocity, meaning that the second layer is in balance

Layer 3:

$$\sigma_{A3.I} := \sigma_{A2.T} = 0.532 \cdot \text{MPa}$$

Incident stress wave

$$\sigma_{A3.R} := \frac{\rho_{A4} \cdot c_{A4} - \rho_{A3} \cdot c_{A3}}{\rho_{A4} \cdot c_{A4} + \rho_{A3} \cdot c_{A3}} \cdot \sigma_{A3.I} = -0.099 \cdot \text{MPa}$$

Reflected stress wave, third layer in Rod A

$$\sigma_{A3.T} := \frac{2 \cdot \rho_{A4} \cdot c_{A4}}{\rho_{A3} \cdot c_{A3} + \rho_{A4} \cdot c_{A4}} \cdot \sigma_{A3.I} = 0.433 \cdot \text{MPa}$$

Transmitted stress wave, third layer in Rod A

$$\sigma_{A3.T} - \sigma_{A3.R} = 0.532 \cdot \text{MPa}$$

Transmitted stress wave minus reflected stress wave equals to the intial stress wave, meaning that the third layer is in balance

$$U_{PI.A3} := \frac{\sigma_{A3.I}}{\rho_{A3} \cdot c_{A3}} = 0.026 \frac{\text{m}}{\text{s}}$$

Incident particle velocity, third layer of Rod A

$$U_{PR.A3} := \frac{-\sigma_{A3.R}}{\rho_{A3} \cdot c_{A3}} = 4.904 \times 10^{-3} \frac{\text{m}}{\text{s}}$$

Reflected particle velocity, third layer of Rod A

$$U_{PT.A3} := \frac{\sigma_{A3.T}}{\rho_{A4} \cdot c_{A4}} = 0.031 \frac{\text{m}}{\text{s}}$$

Transmitted particle velocity, third layer of Rod A

$$U_{PT.A3} - U_{PR.A3} = 0.026 \frac{\text{m}}{\text{s}}$$

Transmitted particle velocity minus reflected particle velocity equals to the incident particle velocity, meaning that the third layer is in balance

Layer 4:

$$\sigma_{A4.I} := \sigma_{A3.T} = 0.433 \cdot \text{MPa}$$

Incident stress wave

$$\sigma_{A4.R} := \frac{\rho_{A5} \cdot c_{A5} - \rho_{A4} \cdot c_{A4}}{\rho_{A5} \cdot c_{A5} + \rho_{A4} \cdot c_{A4}} \cdot \sigma_{A4.I} = -0.081 \cdot \text{MPa}$$

Reflected stress wave, fourth layer in Rod A

$$\sigma_{A4.T} := \frac{2 \cdot \rho_{A5} \cdot c_{A5}}{\rho_{A4} \cdot c_{A4} + \rho_{A5} \cdot c_{A5}} \cdot \sigma_{A4.I} = 0.352 \cdot \text{MPa}$$

Transmitted stress wave, fourth layer in Rod A

$$\sigma_{A4.T} - \sigma_{A4.R} = 0.433 \cdot \text{MPa}$$

Transmitted stress wave minus reflected stress wave equals to the initial stress wave, meaning that the fourth layer is in balance

$$U_{PI.A4} := \frac{\sigma_{A4.I}}{\rho_{A4} \cdot c_{A4}} = 0.031 \frac{\text{m}}{\text{s}}$$

Incident particle velocity, fourth layer of Rod A

$$U_{PR.A4} := \frac{-\sigma_{A4.R}}{\rho_{A4} \cdot c_{A4}} = 5.88 \times 10^{-3} \frac{\text{m}}{\text{s}}$$

Reflected particle velocity, fourth layer of Rod A

$$U_{PT.A4} := \frac{\sigma_{A4.T}}{\rho_{A5} \cdot c_{A5}} = 0.037 \frac{\text{m}}{\text{s}}$$

Transmitted particle velocity, fourth layer of Rod A

$$U_{PT.A4} - U_{PR.A4} = 0.031 \frac{m}{s}$$

Transmitted particle velocity minus reflected particle velocity equals to the incident particle velocity, meaning that the fourth layer is in balance

Layer 5:

$$\sigma_{A5.I} := \sigma_{A4.T} = 0.352 \cdot \text{MPa}$$

Incident stress wave

$$\sigma_{A5.R} := \frac{\rho_{A6} \cdot c_{A6} - \rho_{A5} \cdot c_{A5}}{\rho_{A6} \cdot c_{A6} + \rho_{A5} \cdot c_{A5}} \cdot \sigma_{A5.I} = -0.063 \cdot \text{MPa}$$

Reflected stress wave, fifth layer in Rod A

$$\sigma_{A5.T} := \frac{2 \cdot \rho_{A6} \cdot c_{A6}}{\rho_{A5} \cdot c_{A5} + \rho_{A6} \cdot c_{A6}} \cdot \sigma_{A5.I} = 0.289 \cdot \text{MPa}$$

Transmitted stress wave, fifth layer in Rod A

$$\sigma_{A5.T} - \sigma_{A5.R} = 0.352 \cdot \text{MPa}$$

Transmitted stress wave minus reflected stress wave equals to the initial stress wave, meaning that the fifth layer is in balance

$$U_{PI.A5} := \frac{\sigma_{A5.I}}{\rho_{A5} \cdot c_{A5}} = 0.037 \frac{m}{s}$$

Incident particle velocity, fifth layer of Rod A

$$U_{PR.A5} := \frac{-\sigma_{A5.R}}{\rho_{A5} \cdot c_{A5}} = 6.661 \times 10^{-3} \frac{m}{s}$$

Reflected particle velocity, fifth layer of Rod A

$$U_{PT.A5} := \frac{\sigma_{A5.T}}{\rho_{A6} \cdot c_{A6}} = 0.044 \frac{m}{s}$$

Transmitted particle velocity, fifth layer of Rod A

$$U_{PT.A5} - U_{PR.A5} = 0.037 \frac{m}{s}$$

Transmitted particle velocity minus reflected particle velocity equals to the incident particle velocity, meaning that the fifth layer is in balance

Layer 6:

$$\sigma_{A6.I} := \sigma_{A5.T} = 0.289 \cdot \text{MPa}$$

Incident stress wave

$$\sigma_{A6.R} := \frac{\rho_{A7} \cdot c_{A7} - \rho_{A6} \cdot c_{A6}}{\rho_{A7} \cdot c_{A7} + \rho_{A6} \cdot c_{A6}} \cdot \sigma_{A6.I} = -0.046 \cdot \text{MPa}$$

Reflected stress wave, sixth layer in Rod A

$$\sigma_{A6.T} := \frac{2 \cdot \rho_{A7} \cdot c_{A7}}{\rho_{A6} \cdot c_{A6} + \rho_{A7} \cdot c_{A7}} \cdot \sigma_{A6.I} = 0.243 \cdot \text{MPa}$$

Transmitted stress wave, sixth layer in Rod A

$$\sigma_{A6.T} - \sigma_{A6.R} = 0.289 \cdot \text{MPa}$$

Transmitted stress wave minus reflected stress wave equals to the initial stress wave, meaning that the sixth layer is in balance

$$U_{PI.A6} := \frac{\sigma_{A6.I}}{\rho_{A6} \cdot c_{A6}} = 0.044 \frac{\text{m}}{\text{s}}$$

Incident particle velocity, sixth layer of Rod A

$$U_{PR.A6} := \frac{-\sigma_{A6.R}}{\rho_{A6} \cdot c_{A6}} = 6.979 \times 10^{-3} \frac{\text{m}}{\text{s}}$$

Reflected particle velocity, sixth layer of Rod A

$$U_{PT.A6} := \frac{\sigma_{A6.T}}{\rho_{A7} \cdot c_{A7}} = 0.051 \frac{\text{m}}{\text{s}}$$

Transmitted particle velocity, sixth layer of Rod A

$$U_{PT.A6} - U_{PR.A6} = 0.044 \frac{\text{m}}{\text{s}}$$

Transmitted particle velocity minus reflected particle velocity equals to the incident particle velocity, meaning that the sixth layer is in balance

Layer 7:

$$\sigma_{A7.I} := \sigma_{A6.T} = 0.243 \cdot \text{MPa}$$

Incident stress wave

$$\sigma_{A7.R} := \frac{\rho_{A8} \cdot c_{A8} - \rho_{A7} \cdot c_{A7}}{\rho_{A8} \cdot c_{A8} + \rho_{A7} \cdot c_{A7}} \cdot \sigma_{A7.I} = -0.034 \cdot \text{MPa}$$

Reflected stress wave, seventh layer in Rod A

$$\sigma_{A7.T} := \frac{2 \cdot \rho_{A8} \cdot c_{A8}}{\rho_{A7} \cdot c_{A7} + \rho_{A8} \cdot c_{A8}} \cdot \sigma_{A7.I} = 0.209 \cdot \text{MPa}$$

Transmitted stress wave, seventh layer in Rod A

$$\sigma_{A7.T} - \sigma_{A7.R} = 0.243 \cdot \text{MPa}$$

Transmitted stress wave minus reflected stress wave equals to the initial stress wave, meaning that the seventh layer is in balance

$$U_{PI.A7} := \frac{\sigma_{A7.I}}{\rho_{A7} \cdot c_{A7}} = 0.051 \frac{\text{m}}{\text{s}}$$

Incident particle velocity, seventh layer of Rod A

$$U_{PR.A7} := \frac{-\sigma_{A7.R}}{\rho_{A7} \cdot c_{A7}} = 7.149 \times 10^{-3} \frac{\text{m}}{\text{s}}$$

Reflected particle velocity, seventh layer of Rod A

$$U_{PT.A7} := \frac{\sigma_{A7.T}}{\rho_{A8} \cdot c_{A8}} = 0.058 \frac{\text{m}}{\text{s}}$$

Transmitted particle velocity, seventh layer of Rod A

$$U_{PT.A7} - U_{PR.A7} = 0.051 \frac{\text{m}}{\text{s}}$$

Transmitted particle velocity minus reflected particle velocity equals to the incident particle velocity, meaning that the seventh layer is in balance

Layer 8:

$$\sigma_{A8.I} := \sigma_{A7.T} = 0.209 \cdot \text{MPa}$$

Incident stress wave

$$\sigma_{A8.R} := \frac{\rho_{A9} \cdot c_{A9} - \rho_{A8} \cdot c_{A8}}{\rho_{A9} \cdot c_{A9} + \rho_{A8} \cdot c_{A8}} \cdot \sigma_{A8.I} = -0.033 \cdot \text{MPa}$$

Reflected stress wave, eighth layer in Rod A

$$\sigma_{A8.T} := \frac{2 \cdot \rho_{A9} \cdot c_{A9}}{\rho_{A8} \cdot c_{A8} + \rho_{A9} \cdot c_{A9}} \cdot \sigma_{A8.I} = 0.176 \cdot \text{MPa}$$

Transmitted stress wave, eighth layer in Rod A

$$\sigma_{A8.T} - \sigma_{A8.R} = 0.209 \cdot \text{MPa}$$

Transmitted stress wave minus reflected stress wave equals to the initial stress wave, meaning that the eighth layer is in balance

$$U_{PI.A8} := \frac{\sigma_{A8.I}}{\rho_{A8} \cdot c_{A8}} = 0.058 \frac{\text{m}}{\text{s}}$$

Incident particle velocity, eighth layer of Rod A

$$U_{PR.A8} := \frac{-\sigma_{A8.R}}{\rho_{A8} \cdot c_{A8}} = 9.169 \times 10^{-3} \frac{\text{m}}{\text{s}}$$

Reflected particle velocity, eighth layer of Rod A

$$U_{PT.A8} := \frac{\sigma_{A8.T}}{\rho_{A9} \cdot c_{A9}} = 0.067 \frac{\text{m}}{\text{s}}$$

Transmitted particle velocity, eighth layer of Rod A

$$U_{PT.A8} - U_{PR.A8} = 0.058 \frac{\text{m}}{\text{s}}$$

Transmitted particle velocity minus reflected particle velocity equals to the incident particle velocity, meaning that the eighth layer is in balance

Layer 9:

$$\sigma_{A9.I} := \sigma_{A8.T} = 0.176 \cdot \text{MPa}$$

Incident stress wave

$$\sigma_{A9.R} := \frac{\rho_{A10} \cdot c_{A10} - \rho_{A9} \cdot c_{A9}}{\rho_{A10} \cdot c_{A10} + \rho_{A9} \cdot c_{A9}} \cdot \sigma_{A9.I} = -0.054 \cdot \text{MPa}$$

Reflected stress wave, ninth layer in Rod A

$$\sigma_{A9.T} := \frac{2 \cdot \rho_{A10} \cdot c_{A10}}{\rho_{A9} \cdot c_{A9} + \rho_{A10} \cdot c_{A10}} \cdot \sigma_{A9.I} = 0.122 \cdot \text{MPa}$$

Transmitted stress wave, ninth layer in Rod A

$$\sigma_{A9.T} - \sigma_{A9.R} = 0.176 \cdot \text{MPa}$$

Transmitted stress wave minus reflected stress wave equals to the initial stress wave, meaning that the ninth layer is in balance

$$U_{PI.A9} := \frac{\sigma_{A9.I}}{\rho_{A9} \cdot c_{A9}} = 0.067 \frac{\text{m}}{\text{s}}$$

Incident particle velocity, ninth layer of Rod A

$$U_{PR.A9} := \frac{-\sigma_{A9.R}}{\rho_{A9} \cdot c_{A9}} = 0.02 \frac{\text{m}}{\text{s}}$$

Reflected particle velocity, ninth layer of Rod A

$$U_{PT.A9} := \frac{\sigma_{A9.T}}{\rho_{A10} \cdot c_{A10}} = 0.088 \frac{\text{m}}{\text{s}}$$

Transmitted particle velocity, ninth layer of Rod A

$$U_{PT.A9} - U_{PR.A9} = 0.067 \frac{\text{m}}{\text{s}}$$

Transmitted particle velocity minus reflected particle velocity equals to the incident particle velocity, meaning that the ninth layer is in balance

Layer 10:

$$\sigma_{A10.I} := \sigma_{A9.T} = 0.122 \cdot \text{MPa}$$

Incident stress wave

$$\sigma_{A10.R} := \sigma_{A9.T} = 0.122 \cdot \text{MPa}$$

Reflected stress wave, tenth layer in Rod A

No transmitted stress wave in tenth layer

$$\sigma_{A10.I} + \sigma_{A10.R} = 0.244 \cdot \text{MPa}$$

Balance in the layer

$$U_{PI.A10} := \frac{\sigma_{A10.I}}{\rho_{A10} \cdot c_{A10}} = 0.088 \frac{\text{m}}{\text{s}}$$

Incident particle velocity, tenth layer of Rod A

$$U_{PR.A10} := U_{PI.A10} = 0.088 \frac{\text{m}}{\text{s}}$$

Reflected particle velocity, tenth layer of Rod A

No transmitted stress wave in tenth layer

$$U_{PR.A10} - U_{PI.A10} = 0 \frac{\text{m}}{\text{s}}$$

Balance in the layer

Material parameters Rod B

Material parameters is calculated from Mathematica

Young's modulus:

Density:

Wave velocity:

$$E_{B1} := 1.04229 \cdot 10^{11} \cdot \text{Pa}$$

$$\rho_{B1} := 15584.8 \cdot \frac{\text{kg}}{\text{m}^3}$$

$$c_{B1} := \sqrt{\frac{E_{B1}}{\rho_{B1}}} = 2.586 \times 10^3 \frac{\text{m}}{\text{s}}$$

$$E_{B2} := 7.45281 \cdot 10^{10} \cdot \text{Pa}$$

$$\rho_{B2} := 11143.7 \cdot \frac{\text{kg}}{\text{m}^3}$$

$$c_{B2} := \sqrt{\frac{E_{B2}}{\rho_{B2}}} = 2.586 \times 10^3 \frac{\text{m}}{\text{s}}$$

$$E_{B3} := 5.20824 \cdot 10^{10} \cdot \text{Pa}$$

$$\rho_{B3} := 7787.56 \cdot \frac{\text{kg}}{\text{m}^3}$$

$$c_{B3} := \sqrt{\frac{E_{B3}}{\rho_{B3}}} = 2.586 \times 10^3 \frac{\text{m}}{\text{s}}$$

$$E_{B4} := 3.57671 \cdot 10^{10} \cdot \text{Pa}$$

$$\rho_{B4} := 5348.03 \cdot \frac{\text{kg}}{\text{m}^3}$$

$$c_{B4} := \sqrt{\frac{E_{B4}}{\rho_{B4}}} = 2.586 \times 10^3 \frac{\text{m}}{\text{s}}$$

$$E_{B5} := 2.44569 \cdot 10^{10} \cdot \text{Pa}$$

$$\rho_{B5} := 3656.88 \cdot \frac{\text{kg}}{\text{m}^3}$$

$$c_{B5} := \sqrt{\frac{E_{B5}}{\rho_{B5}}} = 2.586 \times 10^3 \frac{\text{m}}{\text{s}}$$

$$E_{B6} := 1.70267 \cdot 10^{10} \cdot \text{Pa}$$

$$\rho_{B6} := 2545.89 \cdot \frac{\text{kg}}{\text{m}^3}$$

$$c_{B6} := \sqrt{\frac{E_{B6}}{\rho_{B6}}} = 2.586 \times 10^3 \frac{\text{m}}{\text{s}}$$

$$E_{B7} := 1.23513 \cdot 10^{10} \cdot \text{Pa}$$

$$\rho_{B7} := 1846.81 \cdot \frac{\text{kg}}{\text{m}^3}$$

$$c_{B7} := \sqrt{\frac{E_{B7}}{\rho_{B7}}} = 2.586 \times 10^3 \frac{\text{m}}{\text{s}}$$

$$E_{B8} := 9.30547 \cdot 10^9 \cdot \text{Pa}$$

$$\rho_{B8} := 1391.39 \cdot \frac{\text{kg}}{\text{m}^3}$$

$$c_{B8} := \sqrt{\frac{E_{B8}}{\rho_{B8}}} = 2.586 \times 10^3 \frac{\text{m}}{\text{s}}$$

$$E_{B9} := 6.76411 \cdot 10^9 \cdot \text{Pa}$$

$$\rho_{B9} := 1011.4 \cdot \frac{\text{kg}}{\text{m}^3}$$

$$c_{B9} := \sqrt{\frac{E_{B9}}{\rho_{B9}}} = 2.586 \times 10^3 \frac{\text{m}}{\text{s}}$$

$$E_{B10} := 3.60198 \cdot 10^9 \cdot \text{Pa}$$

$$\rho_{B10} := 538.582 \cdot \frac{\text{kg}}{\text{m}^3}$$

$$c_{B10} := \sqrt{\frac{E_{B10}}{\rho_{B10}}} = 2.586 \times 10^3 \frac{\text{m}}{\text{s}}$$

Stresses Rod B

Layer 1:

$$\sigma_{B1.I} := \frac{F}{A} = 0.775 \cdot \text{MPa}$$

Initial stress wave of Rod A and B

$$\sigma_{B1.R} := \frac{\rho_{B2} \cdot c_{B2} - \rho_{B1} \cdot c_{B1}}{\rho_{B2} \cdot c_{B2} + \rho_{B1} \cdot c_{B1}} \cdot \sigma_{I1} = -0.129 \cdot \text{MPa}$$

Reflected stress wave, first layer in Rod B

$$\sigma_{B1.T} := \frac{2 \cdot \rho_{B2} \cdot c_{B2}}{\rho_{B1} \cdot c_{B1} + \rho_{B2} \cdot c_{B2}} \cdot \sigma_{I1} = 0.646 \cdot \text{MPa}$$

Transmitted stress wave, first layer in Rod B

$$\sigma_{B1.T} - \sigma_{A1.R} = 0.775 \cdot \text{MPa}$$

Transmitted stress wave minus reflected stress wave equals to the initial stress wave, meaning that the first layer is in balance

$$U_{PI.B1} := \frac{\sigma_{B1.I}}{\rho_{B1} \cdot c_{B1}} = 0.019 \frac{\text{m}}{\text{s}}$$

Initial particle velocity, first layer of Rod B

$$U_{PR.B1} := \frac{-\sigma_{B1.R}}{\rho_{B1} \cdot c_{B1}} = 3.196 \times 10^{-3} \frac{\text{m}}{\text{s}}$$

Reflected particle velocity, first layer of Rod B

$$U_{PT.B1} := \frac{\sigma_{B1.T}}{\rho_{B2} \cdot c_{B2}} = 0.022 \frac{\text{m}}{\text{s}}$$

Transmitted particle velocity, first layer of Rod B

$$U_{PT.B1} - U_{PR.B1} = 0.019 \frac{\text{m}}{\text{s}}$$

Transmitted particle velocity minus reflected particle velocity equals to the initial particle velocity, meaning that the first layer is in balance

Layer 2:

$$\sigma_{B2.I} := \sigma_{B1.T} = 0.646 \cdot \text{MPa}$$

Incident stress wave

$$\sigma_{B2.R} := \frac{\rho_{B3} \cdot c_{B3} - \rho_{B2} \cdot c_{B2}}{\rho_{B3} \cdot c_{B3} + \rho_{B2} \cdot c_{B2}} \cdot \sigma_{B2.I} = -0.115 \cdot \text{MPa}$$

Reflected stress wave, second layer in Rod B

$$\sigma_{B2.T} := \frac{2 \cdot \rho_{B3} \cdot c_{B3}}{\rho_{B2} \cdot c_{B2} + \rho_{B3} \cdot c_{B3}} \cdot \sigma_{B2.I} = 0.532 \cdot \text{MPa}$$

Transmitted stress wave, second layer in Rod B

$$\sigma_{B2.T} - \sigma_{B2.R} = 0.646 \cdot \text{MPa}$$

Transmitted stress wave minus reflected stress wave equals to the initial stress wave, meaning that the second layer is in balance

$$U_{PI.B2} := \frac{\sigma_{B2.I}}{\rho_{B2} \cdot c_{B2}} = 0.022 \frac{\text{m}}{\text{s}}$$

Incident particle velocity, second layer of Rod B

$$U_{PR.B2} := \frac{-\sigma_{B2.R}}{\rho_{B2} \cdot c_{B2}} = 3.976 \times 10^{-3} \frac{\text{m}}{\text{s}}$$

Reflected particle velocity, second layer of Rod B

$$U_{PT.B2} := \frac{\sigma_{B2.T}}{\rho_{B3} \cdot c_{B3}} = 0.026 \frac{\text{m}}{\text{s}}$$

Transmitted particle velocity, second layer of Rod B

$$U_{PT.B2} - U_{PR.B2} = 0.022 \frac{\text{m}}{\text{s}}$$

Transmitted particle velocity minus reflected particle velocity equals to the incident particle velocity, meaning that the second layer is in balance

Layer 3:

$$\sigma_{B3.I} := \sigma_{B2.T} = 0.532 \cdot \text{MPa}$$

Incident stress wave

$$\sigma_{B3.R} := \frac{\rho_{B4} \cdot c_{B4} - \rho_{B3} \cdot c_{B3}}{\rho_{B4} \cdot c_{B4} + \rho_{B3} \cdot c_{B3}} \cdot \sigma_{B3.I} = -0.099 \cdot \text{MPa}$$

Reflected stress wave, third layer in Rod B

$$\sigma_{B3.T} := \frac{2 \cdot \rho_{B4} \cdot c_{B4}}{\rho_{B3} \cdot c_{B3} + \rho_{B4} \cdot c_{B4}} \cdot \sigma_{B3.I} = 0.433 \cdot \text{MPa}$$

Transmitted stress wave, third layer in Rod B

$$\sigma_{B3.T} - \sigma_{B3.R} = 0.532 \cdot \text{MPa}$$

Transmitted stress wave minus reflected stress wave equals to the initial stress wave, meaning that the third layer is in balance

$$U_{PI.B3} := \frac{\sigma_{B3.I}}{\rho_{B3} \cdot c_{B3}} = 0.026 \frac{\text{m}}{\text{s}}$$

Incident particle velocity, third layer of Rod B

$$U_{PR.B3} := \frac{-\sigma_{B3.R}}{\rho_{B3} \cdot c_{B3}} = 4.904 \times 10^{-3} \frac{\text{m}}{\text{s}}$$

Reflected particle velocity, third layer of Rod B

$$U_{PT.B3} := \frac{\sigma_{B3.T}}{\rho_{B4} \cdot c_{B4}} = 0.031 \frac{\text{m}}{\text{s}}$$

Transmitted particle velocity, third layer of Rod B

$$U_{PT.B3} - U_{PR.B3} = 0.026 \frac{\text{m}}{\text{s}}$$

Transmitted particle velocity minus reflected particle velocity equals to the incident particle velocity, meaning that the third layer is in balance

Layer 4:

$$\sigma_{B4.I} := \sigma_{B3.T} = 0.433 \cdot \text{MPa}$$

Incident stress wave

$$\sigma_{B4.R} := \frac{\rho_{B5} \cdot c_{B5} - \rho_{B4} \cdot c_{B4}}{\rho_{B5} \cdot c_{B5} + \rho_{B4} \cdot c_{B4}} \cdot \sigma_{B4.I} = -0.081 \cdot \text{MPa}$$

Reflected stress wave, fourth layer in Rod B

$$\sigma_{B4.T} := \frac{2 \cdot \rho_{B5} \cdot c_{B5}}{\rho_{B4} \cdot c_{B4} + \rho_{B5} \cdot c_{B5}} \cdot \sigma_{B4.I} = 0.352 \cdot \text{MPa}$$

Transmitted stress wave, fourth layer in Rod B

$$\sigma_{B4.T} - \sigma_{B4.R} = 0.433 \cdot \text{MPa}$$

Transmitted stress wave minus reflected stress wave equals to the initial stress wave, meaning that the fourth layer is in balance

$$U_{PI.B4} := \frac{\sigma_{B4.I}}{\rho_{B4} \cdot c_{B4}} = 0.031 \frac{\text{m}}{\text{s}}$$

Incident particle velocity, fourth layer of Rod B

$$U_{PR.B4} := \frac{-\sigma_{B4.R}}{\rho_{B4} \cdot c_{B4}} = 5.88 \times 10^{-3} \frac{m}{s}$$

Reflected particle velocity, fourth layer of Rod B

$$U_{PT.B4} := \frac{\sigma_{B4.T}}{\rho_{B5} \cdot c_{B5}} = 0.037 \frac{m}{s}$$

Transmitted particle velocity, fourth layer of Rod B

$$U_{PT.B4} - U_{PR.B4} = 0.031 \frac{m}{s}$$

Transmitted particle velocity minus reflected particle velocity equals to the incident particle velocity, meaning that the fourth layer is in balance

Layer 5:

$$\sigma_{B5.I} := \sigma_{B4.T} = 0.352 \cdot \text{MPa}$$

Incident stress wave

$$\sigma_{B5.R} := \frac{\rho_{B6} \cdot c_{B6} - \rho_{B5} \cdot c_{B5}}{\rho_{B6} \cdot c_{B6} + \rho_{B5} \cdot c_{B5}} \cdot \sigma_{B5.I} = -0.063 \cdot \text{MPa}$$

Reflected stress wave, fifth layer in Rod B

$$\sigma_{B5.T} := \frac{2 \cdot \rho_{B6} \cdot c_{B6}}{\rho_{B5} \cdot c_{B5} + \rho_{B6} \cdot c_{B6}} \cdot \sigma_{B5.I} = 0.289 \cdot \text{MPa}$$

Transmitted stress wave, fifth layer in Rod B

$$\sigma_{B5.T} - \sigma_{B5.R} = 0.352 \cdot \text{MPa}$$

Transmitted stress wave minus reflected stress wave equals to the initial stress wave, meaning that the fifth layer is in balance

$$U_{PI.B5} := \frac{\sigma_{B5.I}}{\rho_{B5} \cdot c_{B5}} = 0.037 \frac{m}{s}$$

Incident particle velocity, fifth layer of Rod B

$$U_{PR.B5} := \frac{-\sigma_{B5.R}}{\rho_{B5} \cdot c_{B5}} = 6.661 \times 10^{-3} \frac{m}{s}$$

Reflected particle velocity, fifth layer of Rod B

$$U_{PT.B5} := \frac{\sigma_{B5.T}}{\rho_{B6} \cdot c_{B6}} = 0.044 \frac{m}{s}$$

Transmitted particle velocity, fifth layer of Rod B

$$U_{PT.B5} - U_{PR.B5} = 0.037 \frac{m}{s}$$

Transmitted particle velocity minus reflected particle velocity equals to the incident particle velocity, meaning that the fifth layer is in balance

Layer 6:

$$\sigma_{B6.I} := \sigma_{B5.T} = 0.289 \cdot \text{MPa} \quad \text{Incident stress wave}$$

$$\sigma_{B6.R} := \frac{\rho_{B7} \cdot c_{B7} - \rho_{B6} \cdot c_{B6}}{\rho_{B7} \cdot c_{B7} + \rho_{B6} \cdot c_{B6}} \cdot \sigma_{B6.I} = -0.046 \cdot \text{MPa} \quad \text{Reflected stress wave, sixth layer in Rod B}$$

$$\sigma_{B6.T} := \frac{2 \cdot \rho_{B7} \cdot c_{B7}}{\rho_{B6} \cdot c_{B6} + \rho_{B7} \cdot c_{B7}} \cdot \sigma_{B6.I} = 0.243 \cdot \text{MPa} \quad \text{Transmitted stress wave, sixth layer in Rod B}$$

$$\sigma_{B6.T} - \sigma_{B6.R} = 0.289 \cdot \text{MPa} \quad \text{Transmitted stress wave minus reflected stress wave equals to the initial stress wave, meaning that the sixth layer is in balance}$$

$$U_{PI.B6} := \frac{\sigma_{B6.I}}{\rho_{B6} \cdot c_{B6}} = 0.044 \frac{\text{m}}{\text{s}} \quad \text{Incident particle velocity, sixth layer of Rod B}$$

$$U_{PR.B6} := \frac{-\sigma_{B6.R}}{\rho_{B6} \cdot c_{B6}} = 6.979 \times 10^{-3} \frac{\text{m}}{\text{s}} \quad \text{Reflected particle velocity, sixth layer of Rod B}$$

$$U_{PT.B6} := \frac{\sigma_{B6.T}}{\rho_{B7} \cdot c_{B7}} = 0.051 \frac{\text{m}}{\text{s}} \quad \text{Transmitted particle velocity, sixth layer of Rod B}$$

$$U_{PT.B6} - U_{PR.B6} = 0.044 \frac{\text{m}}{\text{s}} \quad \text{Transmitted particle velocity minus reflected particle velocity equals to the incident particle velocity, meaning that the sixth layer is in balance}$$

Layer 7:

$$\sigma_{B7.I} := \sigma_{B6.T} = 0.243 \cdot \text{MPa} \quad \text{Incident stress wave}$$

$$\sigma_{B7.R} := \frac{\rho_{B8} \cdot c_{B8} - \rho_{B7} \cdot c_{B7}}{\rho_{B8} \cdot c_{B8} + \rho_{B7} \cdot c_{B7}} \cdot \sigma_{B7.I} = -0.034 \cdot \text{MPa} \quad \text{Reflected stress wave, seventh layer in Rod B}$$

$\sigma_{B7.T} := \frac{2 \cdot \rho_{B8} \cdot c_{B8}}{\rho_{B7} \cdot c_{B7} + \rho_{B8} \cdot c_{B8}} \cdot \sigma_{B7.I} = 0.209 \cdot \text{MPa}$	Transmitted stress wave, seventh layer in Rod B
$\sigma_{B7.T} - \sigma_{B7.R} = 0.243 \cdot \text{MPa}$	Transmitted stress wave minus reflected stress wave equals to the initial stress wave, meaning that the seventh layer is in balance
$U_{PI.B7} := \frac{\sigma_{B7.I}}{\rho_{B7} \cdot c_{B7}} = 0.051 \frac{\text{m}}{\text{s}}$	Incident particle velocity, seventh layer of Rod B
$U_{PR.B7} := \frac{-\sigma_{B7.R}}{\rho_{B7} \cdot c_{B7}} = 7.149 \times 10^{-3} \frac{\text{m}}{\text{s}}$	Reflected particle velocity, seventh layer of Rod B
$U_{PT.B7} := \frac{\sigma_{B7.T}}{\rho_{B8} \cdot c_{B8}} = 0.058 \frac{\text{m}}{\text{s}}$	Transmitted particle velocity, seventh layer of Rod B
$U_{PT.B7} - U_{PR.B7} = 0.051 \frac{\text{m}}{\text{s}}$	Transmitted particle velocity minus reflected particle velocity equals to the incident particle velocity, meaning that the seventh layer is in balance

Layer 8:

$\sigma_{B8.I} := \sigma_{B7.T} = 0.209 \cdot \text{MPa}$	Incident stress wave
$\sigma_{B8.R} := \frac{\rho_{B9} \cdot c_{B9} - \rho_{B8} \cdot c_{B8}}{\rho_{B9} \cdot c_{B9} + \rho_{B8} \cdot c_{B8}} \cdot \sigma_{B8.I} = -0.033 \cdot \text{MPa}$	Reflected stress wave, eighth layer in Rod B
$\sigma_{B8.T} := \frac{2 \cdot \rho_{B9} \cdot c_{B9}}{\rho_{B8} \cdot c_{B8} + \rho_{B9} \cdot c_{B9}} \cdot \sigma_{B8.I} = 0.176 \cdot \text{MPa}$	Transmitted stress wave, eighth layer in Rod B
$\sigma_{B8.T} - \sigma_{B8.R} = 0.209 \cdot \text{MPa}$	Transmitted stress wave minus reflected stress wave equals to the initial stress wave, meaning that the eighth layer is in balance

$$U_{PI.B8} := \frac{\sigma_{B8.I}}{\rho_{B8} \cdot c_{B8}} = 0.058 \frac{m}{s}$$

Incident particle velocity, eighth layer of Rod B

$$U_{PR.B8} := \frac{-\sigma_{B8.R}}{\rho_{B8} \cdot c_{B8}} = 9.169 \times 10^{-3} \frac{m}{s}$$

Reflected particle velocity, eighth layer of Rod B

$$U_{PT.B8} := \frac{\sigma_{B8.T}}{\rho_{B9} \cdot c_{B9}} = 0.067 \frac{m}{s}$$

Transmitted particle velocity, eighth layer of Rod B

$$U_{PT.B8} - U_{PR.B8} = 0.058 \frac{m}{s}$$

Transmitted particle velocity minus reflected particle velocity equals to the incident particle velocity, meaning that the eighth layer is in balance

Layer 9:

$$\sigma_{B9.I} := \sigma_{B8.T} = 1 \cdot \text{MPa}$$

Incident stress wave

$$\sigma_{B9.R} := \frac{\rho_{B10} \cdot c_{B10} - \rho_{B9} \cdot c_{B9}}{\rho_{B10} \cdot c_{B10} + \rho_{B9} \cdot c_{B9}} \cdot \sigma_{B9.I} = -0.054 \cdot \text{MPa}$$

Reflected stress wave, ninth layer in Rod B

$$\sigma_{B9.T} := \frac{2 \cdot \rho_{B10} \cdot c_{B10}}{\rho_{B9} \cdot c_{B9} + \rho_{B10} \cdot c_{B10}} \cdot \sigma_{B9.I} = 0.122 \cdot \text{MPa}$$

Transmitted stress wave, ninth layer in Rod B

$$\sigma_{B9.T} - \sigma_{B9.R} = 0.176 \cdot \text{MPa}$$

Transmitted stress wave minus reflected stress wave equals to the initial stress wave, meaning that the ninth layer is in balance

$$U_{PI.B9} := \frac{\sigma_{B9.I}}{\rho_{B9} \cdot c_{B9}} = 0.067 \frac{m}{s}$$

Incident particle velocity, ninth layer of Rod B

$$U_{PR.B9} := \frac{-\sigma_{B9.R}}{\rho_{B9} \cdot c_{B9}} = 0.02 \frac{m}{s}$$

Reflected particle velocity, ninth layer of Rod B

$$U_{PT.B9} := \frac{\sigma_{B9.T}}{\rho_{B10} \cdot c_{B10}} = 0.088 \frac{m}{s}$$

Transmitted particle velocity, ninth layer of Rod B

$$U_{PT.B9} - U_{PR.B9} = 0.067 \frac{\text{m}}{\text{s}}$$

Transmitted particle velocity minus reflected particle velocity equals to the incident particle velocity, meaning that the ninth layer is in balance

Layer 10:

$$\sigma_{B10.I} := \sigma_{B9.T} = 0.122 \cdot \text{MPa}$$

Incident stress wave

$$\sigma_{B10.R} := \sigma_{B9.T} = 0.122 \cdot \text{MPa}$$

Reflected stress wave, tenth layer in Rod B

No transmitted stress wave in tenth layer

$$\sigma_{B10.I} + \sigma_{B10.R} = 0.244 \cdot \text{MPa}$$

Balance in the layer

$$U_{PI.B10} := \frac{\sigma_{B10.I}}{\rho_{B10} \cdot c_{B10}} = 0.088 \frac{\text{m}}{\text{s}}$$

Incident particle velocity, tenth layer of Rod B

$$U_{PR.B10} := U_{PI.B10} = 0.088 \frac{\text{m}}{\text{s}}$$

Reflected particle velocity, tenth layer of Rod B

No transmitted stress wave in tenth layer

$$U_{PR.B10} - U_{PI.B10} = 0 \frac{\text{m}}{\text{s}}$$

Balance in the layer

Transformation with x-function (linear) for real materials, Case Study 5

Following calculations are made with the theory of elastic wave propagation between different materials. This is done in order to compare two Rods (A and B) with different lengths and material parameters. Stresses and particle velocity for incident, reflected and transmitted waves will be determine and presented below.

Material parameters Rod A

Material parameters has been calculated in mathematica

Young's modulus:

Density:

Wave velocity:

$$E_{A1} := 2.100 \cdot 10^{11} \cdot \text{Pa}$$

$$\rho_{A1} := 7800 \frac{\text{kg}}{\text{m}^3}$$

$$c_{A1} := \sqrt{\frac{E_{A1}}{\rho_{A1}}} = 5.189 \times 10^3 \frac{\text{m}}{\text{s}}$$

$$E_{A2} := 2.450 \cdot 10^{11} \cdot \text{Pa}$$

$$\rho_{A2} := 2900 \frac{\text{kg}}{\text{m}^3}$$

$$c_{A2} := \sqrt{\frac{E_{A2}}{\rho_{A2}}} = 9.191 \times 10^3 \frac{\text{m}}{\text{s}}$$

$$E_{A3} := 7.500 \cdot 10^{10} \cdot \text{Pa}$$

$$\rho_{A3} := 5500 \frac{\text{kg}}{\text{m}^3}$$

$$c_{A3} := \sqrt{\frac{E_{A3}}{\rho_{A3}}} = 3.693 \times 10^3 \frac{\text{m}}{\text{s}}$$

$$E_{A4} := 7.00 \cdot 10^{10} \cdot \text{Pa}$$

$$\rho_{A4} := 2700 \frac{\text{kg}}{\text{m}^3}$$

$$c_{A4} := \sqrt{\frac{E_{A4}}{\rho_{A4}}} = 5.092 \times 10^3 \frac{\text{m}}{\text{s}}$$

$$E_{A5} := 4.400 \cdot 10^{10} \cdot \text{Pa}$$

$$\rho_{A5} := 1800 \frac{\text{kg}}{\text{m}^3}$$

$$c_{A5} := \sqrt{\frac{E_{A5}}{\rho_{A5}}} = 4.944 \times 10^3 \frac{\text{m}}{\text{s}}$$

$$E_{A6} := 2.600 \cdot 10^{10} \cdot \text{Pa}$$

$$\rho_{A6} := 1800 \frac{\text{kg}}{\text{m}^3}$$

$$c_{A6} := \sqrt{\frac{E_{A6}}{\rho_{A6}}} = 3.801 \times 10^3 \frac{\text{m}}{\text{s}}$$

$$E_{A7} := 1.700 \cdot 10^{10} \cdot \text{Pa}$$

$$\rho_{A7} := 700 \frac{\text{kg}}{\text{m}^3}$$

$$c_{A7} := \sqrt{\frac{E_{A7}}{\rho_{A7}}} = 4.928 \times 10^3 \frac{\text{m}}{\text{s}}$$

$$E_{A8} := 1.700 \cdot 10^{10} \cdot \text{Pa}$$

$$\rho_{A8} := 700 \frac{\text{kg}}{\text{m}^3}$$

$$c_{A8} := \sqrt{\frac{E_{A8}}{\rho_{A8}}} = 4.928 \times 10^3 \frac{\text{m}}{\text{s}}$$

$$E_{A9} := 3.500 \cdot 10^{10} \cdot \text{Pa}$$

$$\rho_{A9} := 1300 \frac{\text{kg}}{\text{m}^3}$$

$$c_{A9} := \sqrt{\frac{E_{A9}}{\rho_{A9}}} = 5.189 \times 10^3 \frac{\text{m}}{\text{s}}$$

$$E_{A10} := 1.500 \cdot 10^9 \cdot \text{Pa}$$

$$\rho_{A10} := 1400 \frac{\text{kg}}{\text{m}^3}$$

$$c_{A10} := \sqrt{\frac{E_{A10}}{\rho_{A10}}} = 1.035 \times 10^3 \frac{\text{m}}{\text{s}}$$

Stresses in Rod A

$$F := 500\text{N}$$

Force at the left end of the Rod A and B

$$A := 6.450 \cdot 10^{-4} \text{ m}^2$$

Cross section area of Rod A and B

Layer 1:

$$\sigma_{I1} := \frac{F}{A} = 0.775 \cdot \text{MPa}$$

Initial stress wave of Rod A and B

$$\sigma_{A1.R} := \frac{\rho_{A2} \cdot c_{A2} - \rho_{A1} \cdot c_{A1}}{\rho_{A2} \cdot c_{A2} + \rho_{A1} \cdot c_{A1}} \cdot \sigma_{I1} = -0.16 \cdot \text{MPa}$$

Reflected stress wave, first layer in Rod A

$$\sigma_{A1.T} := \frac{2 \cdot \rho_{A2} \cdot c_{A2}}{\rho_{A1} \cdot c_{A1} + \rho_{A2} \cdot c_{A2}} \cdot \sigma_{I1} = 0.616 \cdot \text{MPa}$$

Transmitted stress wave, first layer in Rod A

$$\sigma_{A1.T} - \sigma_{A1.R} = 0.775 \cdot \text{MPa}$$

Transmitted stress wave minus reflected stress wave equals to the initial stress wave, meaning that the first layer is in balance

$$U_{PI.A1} := \frac{\sigma_{I1}}{\rho_{A1} \cdot c_{A1}} = 0.019 \frac{\text{m}}{\text{s}}$$

Initial particle velocity, first layer of Rod A

$$U_{PR.A1} := \frac{-\sigma_{A1.R}}{\rho_{A1} \cdot c_{A1}} = 3.942 \times 10^{-3} \frac{\text{m}}{\text{s}}$$

Reflected particle velocity, first layer of Rod A

$$U_{PT.A1} := \frac{\sigma_{A1.T}}{\rho_{A2} \cdot c_{A2}} = 0.023 \frac{\text{m}}{\text{s}}$$

Transmitted particle velocity, first layer of Rod A

$$U_{PT.A1} - U_{PR.A1} = 0.019 \frac{\text{m}}{\text{s}}$$

Transmitted particle velocity minus reflected particle velocity equals to the initial particle velocity, meaning that the first layer is in balance

Layer 2:

$$\sigma_{A2.I} := \sigma_{A1.T} = 0.616 \cdot \text{MPa}$$

Incident stress wave

$$\sigma_{A2.R} := \frac{\rho_{A3} \cdot c_{A3} - \rho_{A2} \cdot c_{A2}}{\rho_{A3} \cdot c_{A3} + \rho_{A2} \cdot c_{A2}} \cdot \sigma_{A2.I} = -0.083 \cdot \text{MPa}$$

Reflected stress wave, second layer in Rod A

$$\sigma_{A2.T} := \frac{2 \cdot \rho_{A3} \cdot c_{A3}}{\rho_{A2} \cdot c_{A2} + \rho_{A3} \cdot c_{A3}} \cdot \sigma_{A2.I} = 0.532 \cdot \text{MPa}$$

Transmitted stress wave, second layer in Rod A

$$\sigma_{A2.T} - \sigma_{A2.R} = 0.616 \cdot \text{MPa}$$

Transmitted stress wave minus reflected stress wave equals to the incident stress wave, meaning that the second layer is in balance

$$U_{PI.A2} := \frac{\sigma_{A2.I}}{\rho_{A2} \cdot c_{A2}} = 0.023 \frac{\text{m}}{\text{s}}$$

Incident particle velocity, second second of Rod A

$$U_{PR.A2} := \frac{-\sigma_{A2.R}}{\rho_{A2} \cdot c_{A2}} = 3.12 \times 10^{-3} \frac{\text{m}}{\text{s}}$$

Reflected particle velocity, second layer of Rod A

$$U_{PT.A2} := \frac{\sigma_{A2.T}}{\rho_{A3} \cdot c_{A3}} = 0.026 \frac{\text{m}}{\text{s}}$$

Transmitted particle velocity, second layer of Rod A

$$U_{PT.A2} - U_{PR.A2} = 0.023 \frac{\text{m}}{\text{s}}$$

Transmitted particle velocity minus reflected particle velocity equals to the incident particle velocity, meaning that the second layer is in balance

Layer 3:

$$\sigma_{A3.I} := \sigma_{A2.T} = 0.532 \cdot \text{MPa} \quad \text{Incident stress wave}$$

$$\sigma_{A3.R} := \frac{\rho_{A4} \cdot c_{A4} - \rho_{A3} \cdot c_{A3}}{\rho_{A4} \cdot c_{A4} + \rho_{A3} \cdot c_{A3}} \cdot \sigma_{A3.I} = -0.103 \cdot \text{MPa} \quad \text{Reflected stress wave, third layer in Rod A}$$

$$\sigma_{A3.T} := \frac{2 \cdot \rho_{A4} \cdot c_{A4}}{\rho_{A3} \cdot c_{A3} + \rho_{A4} \cdot c_{A4}} \cdot \sigma_{A3.I} = 0.43 \cdot \text{MPa} \quad \text{Transmitted stress wave, third layer in Rod A}$$

$$\sigma_{A3.T} - \sigma_{A3.R} = 0.532 \cdot \text{MPa} \quad \text{Transmitted stress wave minus reflected stress wave equals to the initial stress wave, meaning that the third layer is in balance}$$

$$U_{PI.A3} := \frac{\sigma_{A3.I}}{\rho_{A3} \cdot c_{A3}} = 0.026 \frac{\text{m}}{\text{s}} \quad \text{Incident particle velocity, third layer of Rod A}$$

$$U_{PR.A3} := \frac{-\sigma_{A3.R}}{\rho_{A3} \cdot c_{A3}} = 5.051 \times 10^{-3} \frac{\text{m}}{\text{s}} \quad \text{Reflected particle velocity, third layer of Rod A}$$

$$U_{PT.A3} := \frac{\sigma_{A3.T}}{\rho_{A4} \cdot c_{A4}} = 0.031 \frac{\text{m}}{\text{s}} \quad \text{Transmitted particle velocity, third layer of Rod A}$$

$$U_{PT.A3} - U_{PR.A3} = 0.026 \frac{\text{m}}{\text{s}} \quad \text{Transmitted particle velocity minus reflected particle velocity equals to the incident particle velocity, meaning that the third layer is in balance}$$

Layer 4:

$$\sigma_{A4.I} := \sigma_{A3.T} = 0.43 \cdot \text{MPa} \quad \text{Incident stress wave}$$

$$\sigma_{A4.R} := \frac{\rho_{A5} \cdot c_{A5} - \rho_{A4} \cdot c_{A4}}{\rho_{A5} \cdot c_{A5} + \rho_{A4} \cdot c_{A4}} \cdot \sigma_{A4.I} = -0.092 \cdot \text{MPa} \quad \text{Reflected stress wave, fourth layer in Rod A}$$

$$\sigma_{A4.T} := \frac{2 \cdot \rho_{A5} \cdot c_{A5}}{\rho_{A4} \cdot c_{A4} + \rho_{A5} \cdot c_{A5}} \cdot \sigma_{A4.I} = 0.338 \cdot \text{MPa}$$

Transmitted stress wave, fourth layer in Rod A

$$\sigma_{A4.T} - \sigma_{A4.R} = 0.43 \cdot \text{MPa}$$

Transmitted stress wave minus reflected stress wave equals to the initial stress wave, meaning that the fourth layer is in balance

$$U_{PI.A4} := \frac{\sigma_{A4.I}}{\rho_{A4} \cdot c_{A4}} = 0.031 \frac{\text{m}}{\text{s}}$$

Incident particle velocity, fourth layer of Rod A

$$U_{PR.A4} := \frac{-\sigma_{A4.R}}{\rho_{A4} \cdot c_{A4}} = 6.694 \times 10^{-3} \frac{\text{m}}{\text{s}}$$

Reflected particle velocity, fourth layer of Rod A

$$U_{PT.A4} := \frac{\sigma_{A4.T}}{\rho_{A5} \cdot c_{A5}} = 0.038 \frac{\text{m}}{\text{s}}$$

Transmitted particle velocity, fourth layer of Rod A

$$U_{PT.A4} - U_{PR.A4} = 0.031 \frac{\text{m}}{\text{s}}$$

Transmitted particle velocity minus reflected particle velocity equals to the incident particle velocity, meaning that the fourth layer is in balance

Layer 5:

$$\sigma_{A5.I} := \sigma_{A4.T} = 0.338 \cdot \text{MPa}$$

Incident stress wave

$$\sigma_{A5.R} := \frac{\rho_{A6} \cdot c_{A6} - \rho_{A5} \cdot c_{A5}}{\rho_{A6} \cdot c_{A6} + \rho_{A5} \cdot c_{A5}} \cdot \sigma_{A5.I} = -0.044 \cdot \text{MPa}$$

Reflected stress wave, fifth layer in Rod A

$$\sigma_{A5.T} := \frac{2 \cdot \rho_{A6} \cdot c_{A6}}{\rho_{A5} \cdot c_{A5} + \rho_{A6} \cdot c_{A6}} \cdot \sigma_{A5.I} = 0.294 \cdot \text{MPa}$$

Transmitted stress wave, fifth layer in Rod A

$$\sigma_{A5.T} - \sigma_{A5.R} = 0.338 \cdot \text{MPa}$$

Transmitted stress wave minus reflected stress wave equals to the initial stress wave, meaning that the fifth layer is in balance

$$U_{PI.A5} := \frac{\sigma_{A5.I}}{\rho_{A5} \cdot c_{A5}} = 0.038 \frac{m}{s}$$

Incident particle velocity, fifth layer of Rod A

$$U_{PR.A5} := \frac{-\sigma_{A5.R}}{\rho_{A5} \cdot c_{A5}} = 4.964 \times 10^{-3} \frac{m}{s}$$

Reflected particle velocity, fifth layer of Rod A

$$U_{PT.A5} := \frac{\sigma_{A5.T}}{\rho_{A6} \cdot c_{A6}} = 0.043 \frac{m}{s}$$

Transmitted particle velocity, fifth layer of Rod A

$$U_{PT.A5} - U_{PR.A5} = 0.038 \frac{m}{s}$$

Transmitted particle velocity minus reflected particle velocity equals to the incident particle velocity, meaning that the fifth layer is in balance

Layer 6:

$$\sigma_{A6.I} := \sigma_{A5.T} = 0.294 \cdot \text{MPa}$$

Incident stress wave

$$\sigma_{A6.R} := \frac{\rho_{A7} \cdot c_{A7} - \rho_{A6} \cdot c_{A6}}{\rho_{A7} \cdot c_{A7} + \rho_{A6} \cdot c_{A6}} \cdot \sigma_{A6.I} = -0.097 \cdot \text{MPa}$$

Reflected stress wave, sixth layer in Rod A

$$\sigma_{A6.T} := \frac{2 \cdot \rho_{A7} \cdot c_{A7}}{\rho_{A6} \cdot c_{A6} + \rho_{A7} \cdot c_{A7}} \cdot \sigma_{A6.I} = 0.197 \cdot \text{MPa}$$

Transmitted stress wave, sixth layer in Rod A

$$\sigma_{A6.T} - \sigma_{A6.R} = 0.294 \cdot \text{MPa}$$

Transmitted stress wave minus reflected stress wave equals to the initial stress wave, meaning that the sixth layer is in balance

$$U_{PI.A6} := \frac{\sigma_{A6.I}}{\rho_{A6} \cdot c_{A6}} = 0.043 \frac{m}{s}$$

Incident particle velocity, sixth layer of Rod A

$$U_{PR.A6} := \frac{-\sigma_{A6.R}}{\rho_{A6} \cdot c_{A6}} = 0.014 \frac{m}{s}$$

Reflected particle velocity, sixth layer of Rod A

$$U_{PT.A6} := \frac{\sigma_{A6.T}}{\rho_{A7} \cdot c_{A7}} = 0.057 \frac{m}{s}$$

Transmitted particle velocity, sixth layer of Rod A

$$U_{PT.A6} - U_{PR.A6} = 0.043 \frac{m}{s}$$

Transmitted particle velocity minus reflected particle velocity equals to the incident particle velocity, meaning that the sixth layer is in balance

Layer 7:

$$\sigma_{A7.I} := \sigma_{A6.T} = 0.197 \cdot \text{MPa}$$

Incident stress wave

$$\sigma_{A7.R} := \frac{\rho_{A8} \cdot c_{A8} - \rho_{A7} \cdot c_{A7}}{\rho_{A8} \cdot c_{A8} + \rho_{A7} \cdot c_{A7}} \cdot \sigma_{A7.I} = 0 \cdot \text{MPa}$$

Reflected stress wave, seventh layer in Rod A

$$\sigma_{A7.T} := \frac{2 \cdot \rho_{A8} \cdot c_{A8}}{\rho_{A7} \cdot c_{A7} + \rho_{A8} \cdot c_{A8}} \cdot \sigma_{A7.I} = 0.197 \cdot \text{MPa}$$

Transmitted stress wave, seventh layer in Rod A

$$\sigma_{A7.T} - \sigma_{A7.R} = 0.197 \cdot \text{MPa}$$

Transmitted stress wave minus reflected stress wave equals to the initial stress wave, meaning that the seventh layer is in balance

$$U_{PI.A7} := \frac{\sigma_{A7.I}}{\rho_{A7} \cdot c_{A7}} = 0.057 \frac{m}{s}$$

Incident particle velocity, seventh layer of Rod A

$$U_{PR.A7} := \frac{-\sigma_{A7.R}}{\rho_{A7} \cdot c_{A7}} = 0 \frac{m}{s}$$

Reflected particle velocity, seventh layer of Rod A

$$U_{PT.A7} := \frac{\sigma_{A7.T}}{\rho_{A8} \cdot c_{A8}} = 0.057 \frac{m}{s}$$

Transmitted particle velocity, seventh layer of Rod A

$$U_{PT.A7} - U_{PR.A7} = 0.057 \frac{m}{s}$$

Transmitted particle velocity minus reflected particle velocity equals to the incident particle velocity, meaning that the seventh layer is in balance

Layer 8:

$$\sigma_{A8.I} := \sigma_{A7.T} = 0.197 \cdot \text{MPa}$$

Incident stress wave

$$\sigma_{A8.R} := \frac{\rho_{A9} \cdot c_{A9} - \rho_{A8} \cdot c_{A8}}{\rho_{A9} \cdot c_{A9} + \rho_{A8} \cdot c_{A8}} \cdot \sigma_{A8.I} = 0.064 \cdot \text{MPa}$$

Reflected stress wave, eighth layer in Rod A

$$\sigma_{A8.T} := \frac{2 \cdot \rho_{A9} \cdot c_{A9}}{\rho_{A8} \cdot c_{A8} + \rho_{A9} \cdot c_{A9}} \cdot \sigma_{A8.I} = 0.261 \cdot \text{MPa}$$

Transmitted stress wave, eighth layer in Rod A

$$\sigma_{A8.T} - \sigma_{A8.R} = 0.197 \cdot \text{MPa}$$

Transmitted stress wave minus reflected stress wave equals to the initial stress wave, meaning that the eighth layer is in balance

$$U_{PI.A8} := \frac{\sigma_{A8.I}}{\rho_{A8} \cdot c_{A8}} = 0.057 \frac{m}{s}$$

Incident particle velocity, eighth layer of Rod A

$$U_{PR.A8} := \frac{-\sigma_{A8.R}}{\rho_{A8} \cdot c_{A8}} = -0.018 \frac{m}{s}$$

Reflected particle velocity, eighth layer of Rod A

$$U_{PT.A8} := \frac{\sigma_{A8.T}}{\rho_{A9} \cdot c_{A9}} = 0.039 \frac{m}{s}$$

Transmitted particle velocity, eighth layer of Rod A

$$U_{PT.A8} - U_{PR.A8} = 0.057 \frac{m}{s}$$

Transmitted particle velocity minus reflected particle velocity equals to the incident particle velocity, meaning that the eighth layer is in balance

Layer 9:

$$\sigma_{A9.I} := \sigma_{A8.T} = 0.261 \cdot \text{MPa} \quad \text{Incident stress wave}$$

$$\sigma_{A9.R} := \frac{\rho_{A10} \cdot c_{A10} - \rho_{A9} \cdot c_{A9}}{\rho_{A10} \cdot c_{A10} + \rho_{A9} \cdot c_{A9}} \cdot \sigma_{A9.I} = -0.168 \cdot \text{MPa} \quad \text{Reflected stress wave, ninth layer in Rod A}$$

$$\sigma_{A9.T} := \frac{2 \cdot \rho_{A10} \cdot c_{A10}}{\rho_{A9} \cdot c_{A9} + \rho_{A10} \cdot c_{A10}} \cdot \sigma_{A9.I} = 0.092 \cdot \text{MPa} \quad \text{Transmitted stress wave, ninth layer in Rod A}$$

$$\sigma_{A9.T} - \sigma_{A9.R} = 0.261 \cdot \text{MPa} \quad \text{Transmitted stress wave minus reflected stress wave equals to the initial stress wave, meaning that the ninth layer is in balance}$$

$$U_{PI.A9} := \frac{\sigma_{A9.I}}{\rho_{A9} \cdot c_{A9}} = 0.039 \frac{\text{m}}{\text{s}} \quad \text{Incident particle velocity, ninth layer of Rod A}$$

$$U_{PR.A9} := \frac{-\sigma_{A9.R}}{\rho_{A9} \cdot c_{A9}} = 0.025 \frac{\text{m}}{\text{s}} \quad \text{Reflected particle velocity, ninth layer of Rod A}$$

$$U_{PT.A9} := \frac{\sigma_{A9.T}}{\rho_{A10} \cdot c_{A10}} = 0.064 \frac{\text{m}}{\text{s}} \quad \text{Transmitted particle velocity, ninth layer of Rod A}$$

$$U_{PT.A9} - U_{PR.A9} = 0.039 \frac{\text{m}}{\text{s}} \quad \text{Transmitted particle velocity minus reflected particle velocity equals to the incident particle velocity, meaning that the ninth layer is in balance}$$

Layer 10:

$$\sigma_{A10.I} := \sigma_{A9.T} = 0.092 \cdot \text{MPa} \quad \text{Incident stress wave}$$

$$\sigma_{A10.R} := \sigma_{A9.T} = 0.092 \cdot \text{MPa} \quad \text{Reflected stress wave, tenth layer in Rod A}$$

No transmitted stress wave in tenth layer

$$\sigma_{A10.I} + \sigma_{A10.R} = 0.184 \cdot \text{MPa}$$

Balance in the layer

$$U_{PI.A10} := \frac{\sigma_{A10.I}}{\rho_{A10} \cdot c_{A10}} = 0.064 \frac{\text{m}}{\text{s}}$$

Incident particle velocity, tenth layer of Rod A

$$U_{PR.A10} := U_{PI.A10} = 0.064 \frac{\text{m}}{\text{s}}$$

Reflected particle velocity, tenth layer of Rod A

No transmitted stress wave in tenth layer

$$U_{PR.A10} - U_{PI.A10} = 0 \frac{\text{m}}{\text{s}}$$

Balance in the layer

Calculation of material parameters for case studie five, non-linear psi function, plots

Defines the psi functions and calculating beta(x)

```
poly2[y_] = InterpolatingPolynomial[{{0}, 0, 1}, {{1}, 1/2, 1/2}], x] /. {x -> y}
```

$$y \left(1 + \left(-\frac{1}{2} + \frac{1}{2} (-1 + y) \right) y \right)$$

```
psi = poly2
```

```
poly2
```

```
psiinv = invpoly2
```

```
invpoly2
```

Defines the material functions for Young's modulus and the density

```
ClearAll[E0, rho0]; E0 = 210. * 10^9; rho0 = 7850.;
```

```
Emod[x_] := (-3.750621271678328 * x^3 + 8.943324468199307 * x^2 -  
7.607022512121505 * x + 2.443049644284467) * 10^11
```

```
rho[x_] := (-1.402017951555948 * x^3 + 3.343099860731649 * x^2 -  
2.843577462864469 * x + 0.913235224173003) * 10^4
```

Plots the different material curves for the material properties and the wave velocity

```
emod = Plot[Emod[x], {x, 0, 1}, PlotStyle -> GrayLevel[0],  
AxesOrigin -> {0, 0}, AxesLabel -> {m, Pa}, LabelStyle -> {Black}]
```

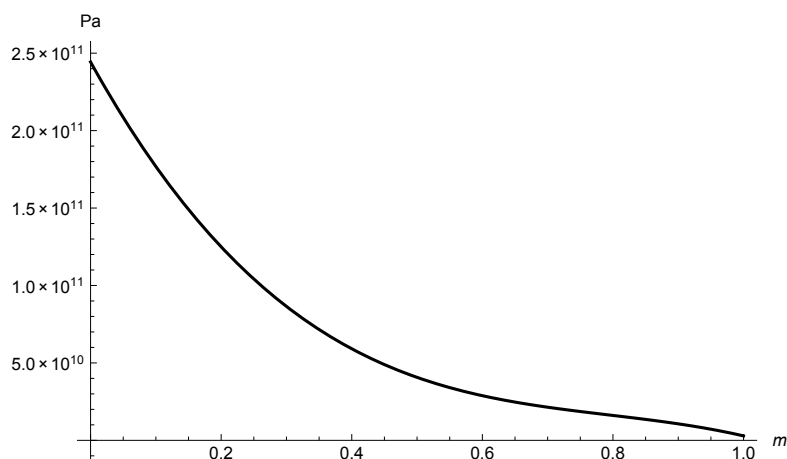

```
rho = Plot[ $\rho[x]$ , {x, 0, 1}, PlotStyle -> GrayLevel[0],
  AxesOrigin -> {0, 0}, AxesLabel -> {m, kg/m^3}, LabelStyle -> {Black}]
```

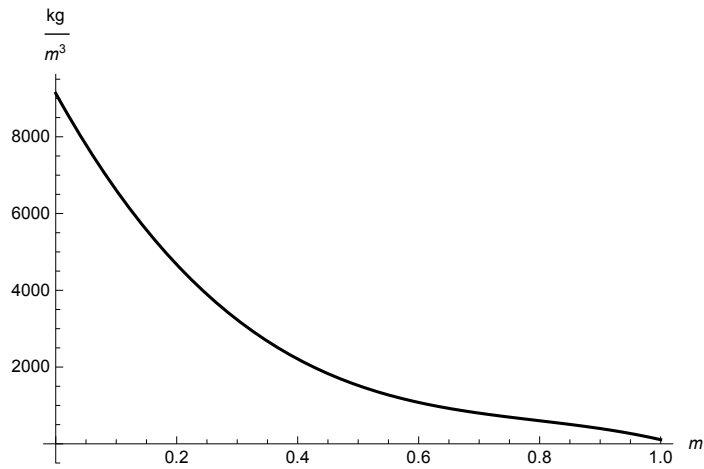

```
rhohat =
```

```
Plot[ $\frac{\rho[\psi\text{inv}[x]]}{\beta[x]}$ , {x, 0, 0.5}, PlotStyle -> GrayLevel[0], AxesOrigin -> {0, 0}]
```

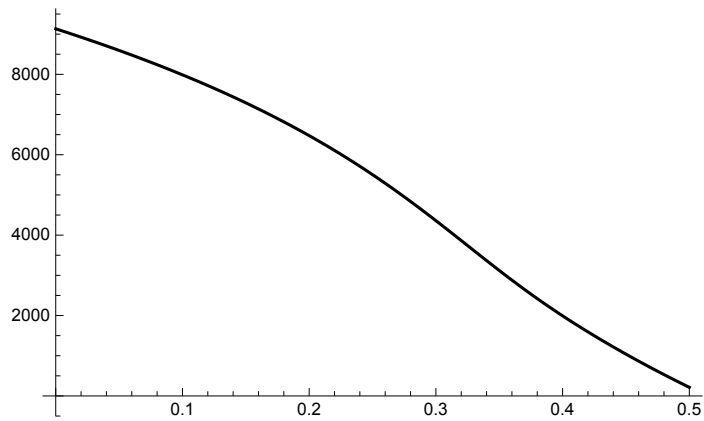

```
ehat = Plot[Emod[ $\psi\text{inv}[x]$ ]  $\beta[x]$ , {x, 0,  $\frac{1}{2}$ },
```

```
PlotStyle -> GrayLevel[0], AxesOrigin -> {0, 0}]
```

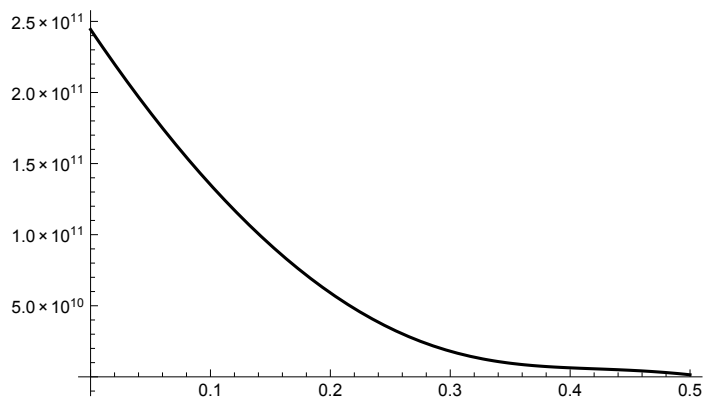

```
vel1 = Plot[ $\sqrt{\frac{\text{Emod}[x]}{\rho[x]}}$ , {x, 0, 1}, PlotStyle -> GrayLevel[0], AxesOrigin -> {0, 0}]
```

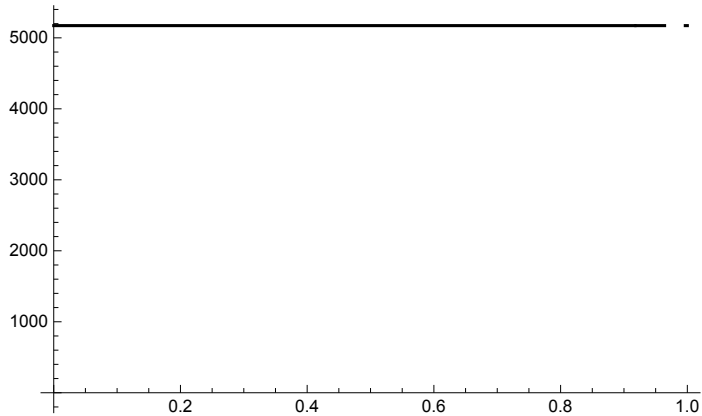

```
vel2 = Plot[ $\sqrt{\frac{\text{Emod}[\psi\text{inv}[x]] \beta[x]}{\frac{\rho[\psi\text{inv}[x]]}{\beta[x]}}}$ , {x, 0, 0.5}, PlotStyle -> GrayLevel[0], AxesOrigin -> {0, 0}]
```

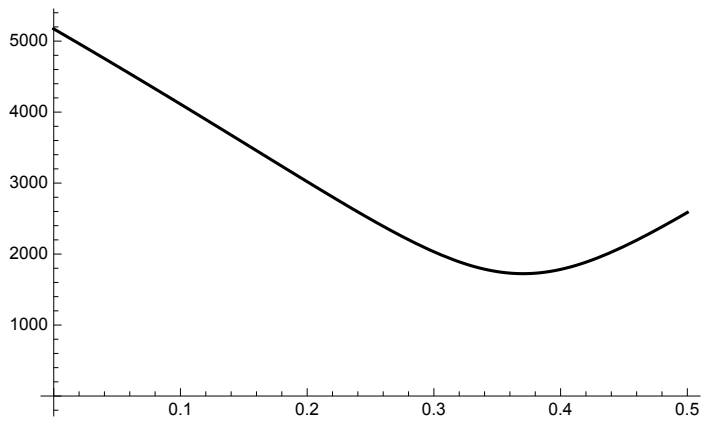

```
Plot[Emod[ψinv[x]], {x, 0, 1}, AxesOrigin -> {0, 0}]
```

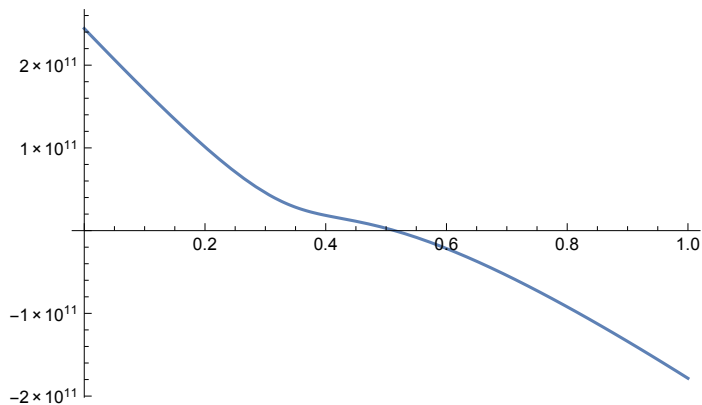

Solve[$y \left(1 + \left(-\frac{1}{2} + \frac{1}{2} (-1 + y) \right) y \right) = x, y]$

$$\left\{ \left\{ y \rightarrow \frac{2}{3} - \frac{2}{3 \left(-10 + 27x + 3\sqrt{3} \sqrt{4 - 20x + 27x^2} \right)^{1/3}} + \frac{1}{3} \left(-10 + 27x + 3\sqrt{3} \sqrt{4 - 20x + 27x^2} \right)^{1/3} \right\}, \right. \\ \left. \left\{ y \rightarrow \frac{2}{3} + \frac{1 + i\sqrt{3}}{3 \left(-10 + 27x + 3\sqrt{3} \sqrt{4 - 20x + 27x^2} \right)^{1/3}} - \frac{1}{6} \left(1 - i\sqrt{3} \right) \left(-10 + 27x + 3\sqrt{3} \sqrt{4 - 20x + 27x^2} \right)^{1/3} \right\}, \right. \\ \left. \left\{ y \rightarrow \frac{2}{3} + \frac{1 - i\sqrt{3}}{3 \left(-10 + 27x + 3\sqrt{3} \sqrt{4 - 20x + 27x^2} \right)^{1/3}} - \frac{1}{6} \left(1 + i\sqrt{3} \right) \left(-10 + 27x + 3\sqrt{3} \sqrt{4 - 20x + 27x^2} \right)^{1/3} \right\} \right\}$$

invpoly2[x_] :=

$$\frac{2}{3} - \frac{2}{3 \left(-10 + 27x + 3\sqrt{3} \sqrt{4 - 20x + 27x^2} \right)^{1/3}} + \frac{1}{3} \left(-10 + 27x + 3\sqrt{3} \sqrt{4 - 20x + 27x^2} \right)^{1/3}$$

$\beta[x_] := \text{poly2}'[\text{invpoly2}[x]]$

Plot[$\beta[x], \{x, 0, 1\}, \text{PlotStyle} \rightarrow \text{GrayLevel}[0], \text{AxesOrigin} \rightarrow \{0, 0\}$]

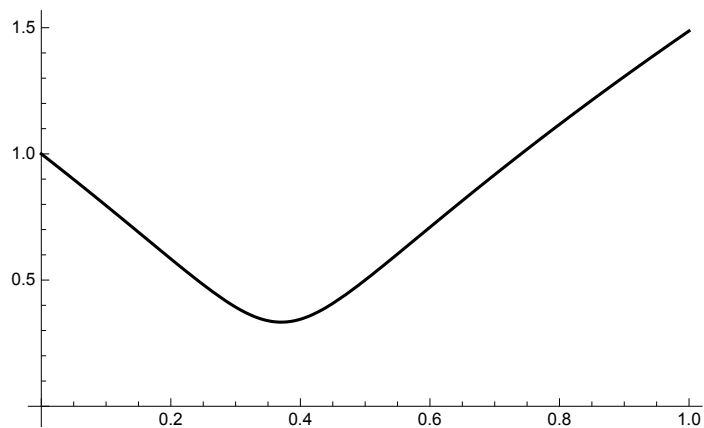

Calculating the material properties from the curves for the transformed and original rods and where the reflections occur

$$\text{MatrixForm}\left[\text{Table}\left[\left\{\mathbf{x}, \mathbf{x} + \frac{0.1}{2}, \text{Emod}[\mathbf{x}], \rho[\mathbf{x}], \text{Emod}[\mathbf{x}] \rho[\mathbf{x}], \psi[\mathbf{x} + 0.05], \sqrt{\frac{\text{Emod}[\mathbf{x}]}{\rho[\mathbf{x}]}}\right\}, \left\{\mathbf{x}, \frac{0.1}{2}, 1 - \frac{0.1}{2}, 0.1\right\}\right]\right]$$

0.05	0.1	2.08459×10^{11}	7792.39	1.62439×10^{15}	0.0905	5172.19
0.15	0.2	1.49056×10^{11}	5571.87	8.30521×10^{14}	0.164	5172.19
0.25	0.3	1.04165×10^{11}	3893.78	4.05595×10^{14}	0.2235	5172.19
0.35	0.4	7.15341×10^{10}	2674.01	1.91283×10^{14}	0.272	5172.19
0.45	0.5	4.89137×10^{10}	1828.44	8.94359×10^{13}	0.3125	5172.19
0.55	0.6	3.40533×10^{10}	1272.95	4.3348×10^{13}	0.348	5172.19
0.65	0.7	2.47025×10^{10}	923.404	2.28104×10^{13}	0.3815	5172.19
0.75	0.8	1.86109×10^{10}	695.695	1.29475×10^{13}	0.416	5172.19
0.85	0.9	1.35282×10^{10}	505.698	6.84119×10^{12}	0.4545	5172.19
0.95	1.	7.20397×10^9	269.291	1.93996×10^{12}	0.5	5172.19

$$\text{MatrixForm}\left[\text{Table}\left[\left\{\mathbf{x}, \psi[\mathbf{x} + \frac{0.1}{2}], \beta[\psi[\mathbf{x}]] \text{Emod}[\mathbf{x}], \frac{\rho[\mathbf{x}]}{\beta[\psi[\mathbf{x}]}}\right\}, \left\{\mathbf{x}, \frac{0.1}{2}, 1 - \frac{0.1}{2}, 0.1\right\}\right]\right]$$

$$\beta[\psi[\mathbf{x}]] \text{Emod}[\mathbf{x}] \frac{\rho[\mathbf{x}]}{\beta[\psi[\mathbf{x}]}} , \sqrt{\frac{\beta[\psi[\mathbf{x}]] \text{Emod}[\mathbf{x}]}{\frac{\rho[\mathbf{x}]}{\beta[\psi[\mathbf{x}]}}}} \}, \left\{\mathbf{x}, \frac{0.1}{2}, 1 - \frac{0.1}{2}, 0.1\right\}\right]$$

0.05	0.0905	1.88395×10^{11}	8622.28	1.62439×10^{15}	4674.37
0.15	0.164	1.0937×10^{11}	7593.68	8.30521×10^{14}	3795.1
0.25	0.2235	6.18479×10^{10}	6557.95	4.05595×10^{14}	3070.99
0.35	0.272	3.46046×10^{10}	5527.68	1.91283×10^{14}	2502.05
0.45	0.3125	1.97489×10^{10}	4528.65	8.94359×10^{13}	2088.27
0.55	0.348	1.20464×10^{10}	3598.43	4.3348×10^{13}	1829.66
0.65	0.3815	8.24447×10^9	2766.75	2.28104×10^{13}	1726.22
0.75	0.416	6.39751×10^9	2023.84	1.29475×10^{13}	1777.94
0.85	0.4545	5.19145×10^9	1317.78	6.84119×10^{12}	1984.83
0.95	0.5	3.2688×10^9	593.479	1.93996×10^{12}	2346.88

Plotting the final plots which shows the transformed and original values for Young's modulus the density and the wave velocity

`emodul = Show[emod, ehat]`

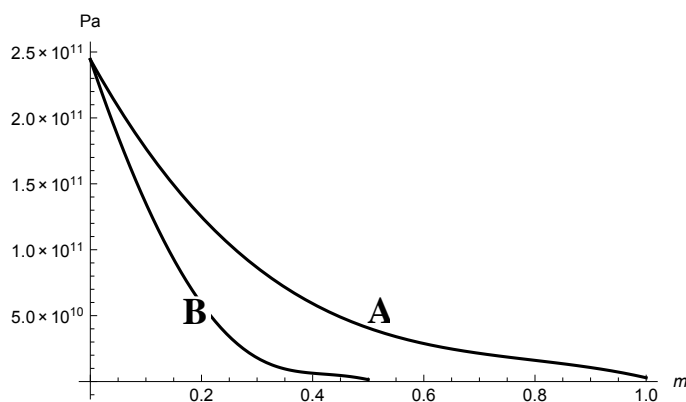

`density = Show[rho, rhohat]`

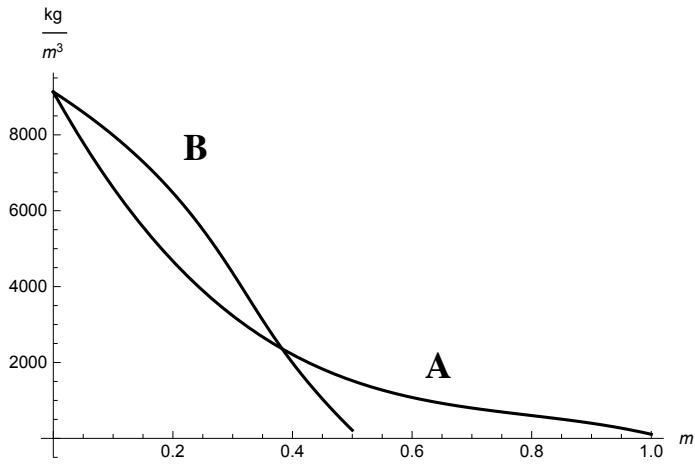

```
velcit = Show[vel1, vel2]
```

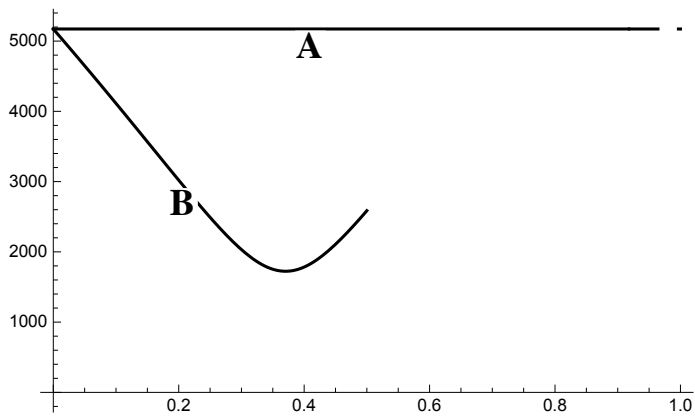

Transformation with x³-function, Case Study 5

Following calculations are made with the theory of elastic wave propagation between different materials. This is done in order to compare two Rods (A and B) with different lengths and material parameters. Stresses and particle velocity for incident, reflected and transmitted waves will be determine and presented below.

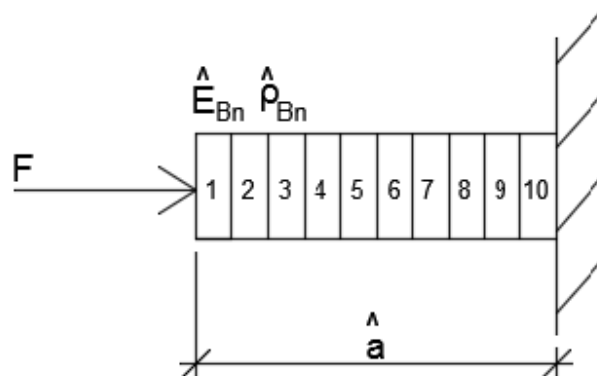
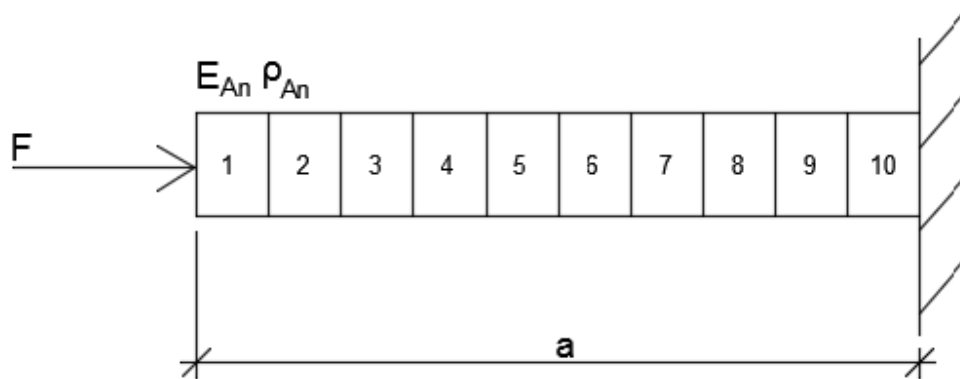

Material parameters Rod A

Material parameters has been calculated in mathematica

Young's modulus:

Density:

Wave velocity:

$$E_{A1} := 2.08459 \cdot 10^{11} \cdot \text{Pa}$$

$$\rho_{A1} := 7792.39 \cdot \frac{\text{kg}}{\text{m}^3}$$

$$c_{A1} := \sqrt{\frac{E_{A1}}{\rho_{A1}}} = 5.172 \times 10^3 \frac{\text{m}}{\text{s}}$$

$$E_{A2} := 1.49056 \cdot 10^{11} \cdot \text{Pa}$$

$$\rho_{A2} := 5571.87 \cdot \frac{\text{kg}}{\text{m}^3}$$

$$c_{A2} := \sqrt{\frac{E_{A2}}{\rho_{A2}}} = 5.172 \times 10^3 \frac{\text{m}}{\text{s}}$$

$$E_{A3} := 1.04165 \cdot 10^{11} \cdot \text{Pa}$$

$$\rho_{A3} := 3893.78 \cdot \frac{\text{kg}}{\text{m}^3}$$

$$c_{A3} := \sqrt{\frac{E_{A3}}{\rho_{A3}}} = 5.172 \times 10^3 \frac{\text{m}}{\text{s}}$$

$$E_{A4} := 7.15341 \cdot 10^{10} \cdot \text{Pa} \quad \rho_{A4} := 2674.01 \cdot \frac{\text{kg}}{\text{m}^3} \quad c_{A4} := \sqrt{\frac{E_{A4}}{\rho_{A4}}} = 5.172 \times 10^3 \frac{\text{m}}{\text{s}}$$

$$E_{A5} := 4.89137 \cdot 10^{10} \cdot \text{Pa} \quad \rho_{A5} := 1828.44 \cdot \frac{\text{kg}}{\text{m}^3} \quad c_{A5} := \sqrt{\frac{E_{A5}}{\rho_{A5}}} = 5.172 \times 10^3 \frac{\text{m}}{\text{s}}$$

$$E_{A6} := 3.40533 \cdot 10^{10} \cdot \text{Pa} \quad \rho_{A6} := 1272.95 \cdot \frac{\text{kg}}{\text{m}^3} \quad c_{A6} := \sqrt{\frac{E_{A6}}{\rho_{A6}}} = 5.172 \times 10^3 \frac{\text{m}}{\text{s}}$$

$$E_{A7} := 2.47025 \cdot 10^{10} \cdot \text{Pa} \quad \rho_{A7} := 923.404 \cdot \frac{\text{kg}}{\text{m}^3} \quad c_{A7} := \sqrt{\frac{E_{A7}}{\rho_{A7}}} = 5.172 \times 10^3 \frac{\text{m}}{\text{s}}$$

$$E_{A8} := 1.86109 \cdot 10^{10} \cdot \text{Pa} \quad \rho_{A8} := 695.695 \cdot \frac{\text{kg}}{\text{m}^3} \quad c_{A8} := \sqrt{\frac{E_{A8}}{\rho_{A8}}} = 5.172 \times 10^3 \frac{\text{m}}{\text{s}}$$

$$E_{A9} := 1.35282 \cdot 10^{10} \cdot \text{Pa} \quad \rho_{A9} := 505.698 \cdot \frac{\text{kg}}{\text{m}^3} \quad c_{A9} := \sqrt{\frac{E_{A9}}{\rho_{A9}}} = 5.172 \times 10^3 \frac{\text{m}}{\text{s}}$$

$$E_{A10} := 7.20397 \cdot 10^9 \cdot \text{Pa} \quad \rho_{A10} := 269.291 \cdot \frac{\text{kg}}{\text{m}^3} \quad c_{A10} := \sqrt{\frac{E_{A10}}{\rho_{A10}}} = 5.172 \times 10^3 \frac{\text{m}}{\text{s}}$$

Wave Velocity:

$$c_A := \sqrt{\frac{E_{A1}}{\rho_{A1}}} = 5.172 \times 10^3 \frac{\text{m}}{\text{s}}$$

Stresses in Rod A

$$F := 500\text{N}$$

Force at the left end of the Rod A and B

$$A := 6.450 \cdot 10^{-4} \text{m}^2$$

Cross section area of Rod A and B

Layer 1:

$$\sigma_{I1} := \frac{F}{A} = 0.775 \cdot \text{MPa}$$

Initial stress wave of Rod A and B

$$\sigma_{A1.R} := \frac{\rho_{A2} \cdot c_{A2} - \rho_{A1} \cdot c_{A1}}{\rho_{A2} \cdot c_{A2} + \rho_{A1} \cdot c_{A1}} \cdot \sigma_{I1} = -0.129 \cdot \text{MPa}$$

Reflected stress wave, first layer in Rod A

$$\sigma_{A1.T} := \frac{2 \cdot \rho_{A2} \cdot c_{A2}}{\rho_{A1} \cdot c_{A1} + \rho_{A2} \cdot c_{A2}} \cdot \sigma_{I1} = 0.646 \cdot \text{MPa}$$

Transmitted stress wave, first layer in Rod A

$$\sigma_{A1.T} - \sigma_{A1.R} = 0.775 \cdot \text{MPa}$$

Transmitted stress wave minus reflected stress wave equals to the initial stress wave, meaning that the first layer is in balance

$$U_{PI.A1} := \frac{\sigma_{I1}}{\rho_{A1} \cdot c_{A1}} = 0.019 \frac{\text{m}}{\text{s}}$$

Initial particle velocity, first layer of Rod A

$$U_{PR.A1} := \frac{-\sigma_{A1.R}}{\rho_{A1} \cdot c_{A1}} = 3.196 \times 10^{-3} \frac{\text{m}}{\text{s}}$$

Reflected particle velocity, first layer of Rod A

$$U_{PT.A1} := \frac{\sigma_{A1.T}}{\rho_{A2} \cdot c_{A2}} = 0.022 \frac{\text{m}}{\text{s}}$$

Transmitted particle velocity, first layer of Rod A

$$U_{PT.A1} - U_{PR.A1} = 0.019 \frac{\text{m}}{\text{s}}$$

Transmitted particle velocity minus reflected particle velocity equals to the initial particle velocity, meaning that the first layer is in balance

Layer 2:

$$\sigma_{A2.I} := \sigma_{A1.T} = 0.646 \cdot \text{MPa}$$

Incident stress wave

$$\sigma_{A2.R} := \frac{\rho_{A3} \cdot c_{A3} - \rho_{A2} \cdot c_{A2}}{\rho_{A3} \cdot c_{A3} + \rho_{A2} \cdot c_{A2}} \cdot \sigma_{A2.I} = -0.115 \cdot \text{MPa}$$

Reflected stress wave, second layer in Rod A

$$\sigma_{A2.T} := \frac{2 \cdot \rho_{A3} \cdot c_{A3}}{\rho_{A2} \cdot c_{A2} + \rho_{A3} \cdot c_{A3}} \cdot \sigma_{A2.I} = 0.532 \cdot \text{MPa}$$

Transmitted stress wave, second layer in Rod A

$$\sigma_{A2.T} - \sigma_{A2.R} = 0.646 \cdot \text{MPa}$$

Transmitted stress wave minus reflected stress wave equals to the incident stress wave, meaning that the second layer is in balance

$$U_{PI.A2} := \frac{\sigma_{A2.I}}{\rho_{A2} \cdot c_{A2}} = 0.022 \frac{\text{m}}{\text{s}}$$

Incident particle velocity, second second of Rod A

$$U_{PR.A2} := \frac{-\sigma_{A2.R}}{\rho_{A2} \cdot c_{A2}} = 3.976 \times 10^{-3} \frac{\text{m}}{\text{s}}$$

Reflected particle velocity, second layer of Rod A

$$U_{PT.A2} := \frac{\sigma_{A2.T}}{\rho_{A3} \cdot c_{A3}} = 0.026 \frac{\text{m}}{\text{s}}$$

Transmitted particle velocity, second layer of Rod A

$$U_{PT.A2} - U_{PR.A2} = 0.022 \frac{\text{m}}{\text{s}}$$

Transmitted particle velocity minus reflected particle velocity equals to the incident particle velocity, meaning that the second layer is in balance

Layer 3:

$$\sigma_{A3.I} := \sigma_{A2.T} = 0.532 \cdot \text{MPa}$$

Incident stress wave

$$\sigma_{A3.R} := \frac{\rho_{A4} \cdot c_{A4} - \rho_{A3} \cdot c_{A3}}{\rho_{A4} \cdot c_{A4} + \rho_{A3} \cdot c_{A3}} \cdot \sigma_{A3.I} = -0.099 \cdot \text{MPa}$$

Reflected stress wave, third layer in Rod A

$$\sigma_{A3.T} := \frac{2 \cdot \rho_{A4} \cdot c_{A4}}{\rho_{A3} \cdot c_{A3} + \rho_{A4} \cdot c_{A4}} \cdot \sigma_{A3.I} = 0.433 \cdot \text{MPa}$$

Transmitted stress wave, third layer in Rod A

$$\sigma_{A3.T} - \sigma_{A3.R} = 0.532 \cdot \text{MPa}$$

Transmitted stress wave minus reflected stress wave equals to the initial stress wave, meaning that the third layer is in balance

$$U_{PI.A3} := \frac{\sigma_{A3.I}}{\rho_{A3} \cdot c_{A3}} = 0.026 \frac{\text{m}}{\text{s}}$$

Incident particle velocity, third layer of Rod A

$$U_{PR.A3} := \frac{-\sigma_{A3.R}}{\rho_{A3} \cdot c_{A3}} = 4.904 \times 10^{-3} \frac{\text{m}}{\text{s}}$$

Reflected particle velocity, third layer of Rod A

$$U_{PT.A3} := \frac{\sigma_{A3.T}}{\rho_{A4} \cdot c_{A4}} = 0.031 \frac{\text{m}}{\text{s}}$$

Transmitted particle velocity, third layer of Rod A

$$U_{PT.A3} - U_{PR.A3} = 0.026 \frac{\text{m}}{\text{s}}$$

Transmitted particle velocity minus reflected particle velocity equals to the incident particle velocity, meaning that the third layer is in balance

Layer 4:

$$\sigma_{A4.I} := \sigma_{A3.T} = 0.433 \cdot \text{MPa}$$

Incident stress wave

$$\sigma_{A4.R} := \frac{\rho_{A5} \cdot c_{A5} - \rho_{A4} \cdot c_{A4}}{\rho_{A5} \cdot c_{A5} + \rho_{A4} \cdot c_{A4}} \cdot \sigma_{A4.I} = -0.081 \cdot \text{MPa}$$

Reflected stress wave, fourth layer in Rod A

$$\sigma_{A4.T} := \frac{2 \cdot \rho_{A5} \cdot c_{A5}}{\rho_{A4} \cdot c_{A4} + \rho_{A5} \cdot c_{A5}} \cdot \sigma_{A4.I} = 0.352 \cdot \text{MPa}$$

Transmitted stress wave, fourth layer in Rod A

$$\sigma_{A4.T} - \sigma_{A4.R} = 0.433 \cdot \text{MPa}$$

Transmitted stress wave minus reflected stress wave equals to the initial stress wave, meaning that the fourth layer is in balance

$$U_{PI.A4} := \frac{\sigma_{A4.I}}{\rho_{A4} \cdot c_{A4}} = 0.031 \frac{\text{m}}{\text{s}}$$

Incident particle velocity, fourth layer of Rod A

$$U_{PR.A4} := \frac{-\sigma_{A4.R}}{\rho_{A4} \cdot c_{A4}} = 5.88 \times 10^{-3} \frac{\text{m}}{\text{s}}$$

Reflected particle velocity, fourth layer of Rod A

$$U_{PT.A4} := \frac{\sigma_{A4.T}}{\rho_{A5} \cdot c_{A5}} = 0.037 \frac{\text{m}}{\text{s}}$$

Transmitted particle velocity, fourth layer of Rod A

$$U_{PT.A4} - U_{PR.A4} = 0.031 \frac{m}{s}$$

Transmitted particle velocity minus reflected particle velocity equals to the incident particle velocity, meaning that the fourth layer is in balance

Layer 5:

$$\sigma_{A5.I} := \sigma_{A4.T} = 0.352 \cdot \text{MPa}$$

Incident stress wave

$$\sigma_{A5.R} := \frac{\rho_{A6} \cdot c_{A6} - \rho_{A5} \cdot c_{A5}}{\rho_{A6} \cdot c_{A6} + \rho_{A5} \cdot c_{A5}} \cdot \sigma_{A5.I} = -0.063 \cdot \text{MPa}$$

Reflected stress wave, fifth layer in Rod A

$$\sigma_{A5.T} := \frac{2 \cdot \rho_{A6} \cdot c_{A6}}{\rho_{A5} \cdot c_{A5} + \rho_{A6} \cdot c_{A6}} \cdot \sigma_{A5.I} = 0.289 \cdot \text{MPa}$$

Transmitted stress wave, fifth layer in Rod A

$$\sigma_{A5.T} - \sigma_{A5.R} = 0.352 \cdot \text{MPa}$$

Transmitted stress wave minus reflected stress wave equals to the initial stress wave, meaning that the fifth layer is in balance

$$U_{PI.A5} := \frac{\sigma_{A5.I}}{\rho_{A5} \cdot c_{A5}} = 0.037 \frac{m}{s}$$

Incident particle velocity, fifth layer of Rod A

$$U_{PR.A5} := \frac{-\sigma_{A5.R}}{\rho_{A5} \cdot c_{A5}} = 6.661 \times 10^{-3} \frac{m}{s}$$

Reflected particle velocity, fifth layer of Rod A

$$U_{PT.A5} := \frac{\sigma_{A5.T}}{\rho_{A6} \cdot c_{A6}} = 0.044 \frac{m}{s}$$

Transmitted particle velocity, fifth layer of Rod A

$$U_{PT.A5} - U_{PR.A5} = 0.037 \frac{m}{s}$$

Transmitted particle velocity minus reflected particle velocity equals to the incident particle velocity, meaning that the fifth layer is in balance

Layer 6:

$$\sigma_{A6.I} := \sigma_{A5.T} = 0.289 \cdot \text{MPa}$$

Incident stress wave

$$\sigma_{A6.R} := \frac{\rho_{A7} \cdot c_{A7} - \rho_{A6} \cdot c_{A6}}{\rho_{A7} \cdot c_{A7} + \rho_{A6} \cdot c_{A6}} \cdot \sigma_{A6.I} = -0.046 \cdot \text{MPa}$$

Reflected stress wave, sixth layer in Rod A

$$\sigma_{A6.T} := \frac{2 \cdot \rho_{A7} \cdot c_{A7}}{\rho_{A6} \cdot c_{A6} + \rho_{A7} \cdot c_{A7}} \cdot \sigma_{A6.I} = 0.243 \cdot \text{MPa}$$

Transmitted stress wave, sixth layer in Rod A

$$\sigma_{A6.T} - \sigma_{A6.R} = 0.289 \cdot \text{MPa}$$

Transmitted stress wave minus reflected stress wave equals to the initial stress wave, meaning that the sixth layer is in balance

$$U_{PI.A6} := \frac{\sigma_{A6.I}}{\rho_{A6} \cdot c_{A6}} = 0.044 \frac{\text{m}}{\text{s}}$$

Incident particle velocity, sixth layer of Rod A

$$U_{PR.A6} := \frac{-\sigma_{A6.R}}{\rho_{A6} \cdot c_{A6}} = 6.979 \times 10^{-3} \frac{\text{m}}{\text{s}}$$

Reflected particle velocity, sixth layer of Rod A

$$U_{PT.A6} := \frac{\sigma_{A6.T}}{\rho_{A7} \cdot c_{A7}} = 0.051 \frac{\text{m}}{\text{s}}$$

Transmitted particle velocity, sixth layer of Rod A

$$U_{PT.A6} - U_{PR.A6} = 0.044 \frac{\text{m}}{\text{s}}$$

Transmitted particle velocity minus reflected particle velocity equals to the incident particle velocity, meaning that the sixth layer is in balance

Layer 7:

$$\sigma_{A7.I} := \sigma_{A6.T} = 0.243 \cdot \text{MPa}$$

Incident stress wave

$$\sigma_{A7.R} := \frac{\rho_{A8} \cdot c_{A8} - \rho_{A7} \cdot c_{A7}}{\rho_{A8} \cdot c_{A8} + \rho_{A7} \cdot c_{A7}} \cdot \sigma_{A7.I} = -0.034 \cdot \text{MPa}$$

Reflected stress wave, seventh layer in Rod A

$$\sigma_{A7.T} := \frac{2 \cdot \rho_{A8} \cdot c_{A8}}{\rho_{A7} \cdot c_{A7} + \rho_{A8} \cdot c_{A8}} \cdot \sigma_{A7.I} = 0.209 \cdot \text{MPa}$$

Transmitted stress wave, seventh layer in Rod A

$$\sigma_{A7.T} - \sigma_{A7.R} = 0.243 \cdot \text{MPa}$$

Transmitted stress wave minus reflected stress wave equals to the initial stress wave, meaning that the seventh layer is in balance

$$U_{PI.A7} := \frac{\sigma_{A7.I}}{\rho_{A7} \cdot c_{A7}} = 0.051 \frac{\text{m}}{\text{s}}$$

Incident particle velocity, seventh layer of Rod A

$$U_{PR.A7} := \frac{-\sigma_{A7.R}}{\rho_{A7} \cdot c_{A7}} = 7.149 \times 10^{-3} \frac{\text{m}}{\text{s}}$$

Reflected particle velocity, seventh layer of Rod A

$$U_{PT.A7} := \frac{\sigma_{A7.T}}{\rho_{A8} \cdot c_{A8}} = 0.058 \frac{\text{m}}{\text{s}}$$

Transmitted particle velocity, seventh layer of Rod A

$$U_{PT.A7} - U_{PR.A7} = 0.051 \frac{\text{m}}{\text{s}}$$

Transmitted particle velocity minus reflected particle velocity equals to the incident particle velocity, meaning that the seventh layer is in balance

Layer 8:

$$\sigma_{A8.I} := \sigma_{A7.T} = 0.209 \cdot \text{MPa}$$

Incident stress wave

$$\sigma_{A8.R} := \frac{\rho_{A9} \cdot c_{A9} - \rho_{A8} \cdot c_{A8}}{\rho_{A9} \cdot c_{A9} + \rho_{A8} \cdot c_{A8}} \cdot \sigma_{A8.I} = -0.033 \cdot \text{MPa}$$

Reflected stress wave, eighth layer in Rod A

$$\sigma_{A8.T} := \frac{2 \cdot \rho_{A9} \cdot c_{A9}}{\rho_{A8} \cdot c_{A8} + \rho_{A9} \cdot c_{A9}} \cdot \sigma_{A8.I} = 0.176 \cdot \text{MPa}$$

Transmitted stress wave, eighth layer in Rod A

$$\sigma_{A8.T} - \sigma_{A8.R} = 0.209 \cdot \text{MPa}$$

Transmitted stress wave minus reflected stress wave equals to the initial stress wave, meaning that the eighth layer is in balance

$$U_{PI.A8} := \frac{\sigma_{A8.I}}{\rho_{A8} \cdot c_{A8}} = 0.058 \frac{\text{m}}{\text{s}}$$

Incident particle velocity, eighth layer of Rod A

$$U_{PR.A8} := \frac{-\sigma_{A8.R}}{\rho_{A8} \cdot c_{A8}} = 9.169 \times 10^{-3} \frac{\text{m}}{\text{s}}$$

Reflected particle velocity, eighth layer of Rod A

$$U_{PT.A8} := \frac{\sigma_{A8.T}}{\rho_{A9} \cdot c_{A9}} = 0.067 \frac{\text{m}}{\text{s}}$$

Transmitted particle velocity, eighth layer of Rod A

$$U_{PT.A8} - U_{PR.A8} = 0.058 \frac{\text{m}}{\text{s}}$$

Transmitted particle velocity minus reflected particle velocity equals to the incident particle velocity, meaning that the eighth layer is in balance

Layer 9:

$$\sigma_{A9.I} := \sigma_{A8.T} = 0.176 \cdot \text{MPa}$$

Incident stress wave

$$\sigma_{A9.R} := \frac{\rho_{A10} \cdot c_{A10} - \rho_{A9} \cdot c_{A9}}{\rho_{A10} \cdot c_{A10} + \rho_{A9} \cdot c_{A9}} \cdot \sigma_{A9.I} = -0.054 \cdot \text{MPa}$$

Reflected stress wave, ninth layer in Rod A

$$\sigma_{A9.T} := \frac{2 \cdot \rho_{A10} \cdot c_{A10}}{\rho_{A9} \cdot c_{A9} + \rho_{A10} \cdot c_{A10}} \cdot \sigma_{A9.I} = 0.122 \cdot \text{MPa}$$

Transmitted stress wave, ninth layer in Rod A

$$\sigma_{A9.T} - \sigma_{A9.R} = 0.176 \cdot \text{MPa}$$

Transmitted stress wave minus reflected stress wave equals to the initial stress wave, meaning that the ninth layer is in balance

$$U_{PI.A9} := \frac{\sigma_{A9.I}}{\rho_{A9} \cdot c_{A9}} = 0.067 \frac{\text{m}}{\text{s}}$$

Incident particle velocity, ninth layer of Rod A

$$U_{PR.A9} := \frac{-\sigma_{A9.R}}{\rho_{A9} \cdot c_{A9}} = 0.02 \frac{\text{m}}{\text{s}}$$

Reflected particle velocity, ninth layer of Rod A

$$U_{PT.A9} := \frac{\sigma_{A9.T}}{\rho_{A10} \cdot c_{A10}} = 0.088 \frac{\text{m}}{\text{s}}$$

Transmitted particle velocity, ninth layer of Rod A

$$U_{PT.A9} - U_{PR.A9} = 0.067 \frac{\text{m}}{\text{s}}$$

Transmitted particle velocity minus reflected particle velocity equals to the incident particle velocity, meaning that the ninth layer is in balance

Layer 10:

$$\sigma_{A10.I} := \sigma_{A9.T} = 0.122 \cdot \text{MPa}$$

Incident stress wave

$$\sigma_{A10.R} := \sigma_{A9.T} = 0.122 \cdot \text{MPa}$$

Reflected stress wave, tenth layer in Rod A

No transmitted stress wave in tenth layer

$$\sigma_{A10.I} + \sigma_{A10.R} = 0.244 \cdot \text{MPa}$$

Balance in the layer

$$U_{PI.A10} := \frac{\sigma_{A10.I}}{\rho_{A10} \cdot c_{A10}} = 0.088 \frac{\text{m}}{\text{s}}$$

Incident particle velocity, tenth layer of Rod A

$$U_{PR.A10} := U_{PI.A10} = 0.088 \frac{\text{m}}{\text{s}}$$

Reflected particle velocity, tenth layer of Rod A

No transmitted stress wave in tenth layer

$$U_{PR.A10} - U_{PI.A10} = 0 \frac{\text{m}}{\text{s}}$$

Balance in the layer

Material parameters Rod B

Material parameters is calculated from Mathematica

Young's modulus:

Density:

Wave velocity:

$$E_{B1} := 1.88395 \cdot 10^{11} \cdot \text{Pa}$$

$$\rho_{B1} := 8622.28 \cdot \frac{\text{kg}}{\text{m}^3}$$

$$c_{B1} := \sqrt{\frac{E_{B1}}{\rho_{B1}}} = 4.674 \times 10^3 \frac{\text{m}}{\text{s}}$$

$$E_{B2} := 1.0937 \cdot 10^{11} \cdot \text{Pa}$$

$$\rho_{B2} := 7593.68 \cdot \frac{\text{kg}}{\text{m}^3}$$

$$c_{B2} := \sqrt{\frac{E_{B2}}{\rho_{B2}}} = 3.795 \times 10^3 \frac{\text{m}}{\text{s}}$$

$$E_{B3} := 6.18479 \cdot 10^{10} \cdot \text{Pa}$$

$$\rho_{B3} := 6557.95 \cdot \frac{\text{kg}}{\text{m}^3}$$

$$c_{B3} := \sqrt{\frac{E_{B3}}{\rho_{B3}}} = 3.071 \times 10^3 \frac{\text{m}}{\text{s}}$$

$$E_{B4} := 3.46046 \cdot 10^{10} \cdot \text{Pa}$$

$$\rho_{B4} := 5527.68 \cdot \frac{\text{kg}}{\text{m}^3}$$

$$c_{B4} := \sqrt{\frac{E_{B4}}{\rho_{B4}}} = 2.502 \times 10^3 \frac{\text{m}}{\text{s}}$$

$$E_{B5} := 1.97489 \cdot 10^{10} \cdot \text{Pa}$$

$$\rho_{B5} := 4528.65 \cdot \frac{\text{kg}}{\text{m}^3}$$

$$c_{B5} := \sqrt{\frac{E_{B5}}{\rho_{B5}}} = 2.088 \times 10^3 \frac{\text{m}}{\text{s}}$$

$$E_{B6} := 1.20464 \cdot 10^{10} \cdot \text{Pa}$$

$$\rho_{B6} := 3598.43 \cdot \frac{\text{kg}}{\text{m}^3}$$

$$c_{B6} := \sqrt{\frac{E_{B6}}{\rho_{B6}}} = 1.83 \times 10^3 \frac{\text{m}}{\text{s}}$$

$$E_{B7} := 8.24447 \cdot 10^9 \cdot \text{Pa}$$

$$\rho_{B7} := 2766.75 \cdot \frac{\text{kg}}{\text{m}^3}$$

$$c_{B7} := \sqrt{\frac{E_{B7}}{\rho_{B7}}} = 1.726 \times 10^3 \frac{\text{m}}{\text{s}}$$

$$E_{B8} := 6.39751 \cdot 10^9 \cdot \text{Pa}$$

$$\rho_{B8} := 2023.84 \cdot \frac{\text{kg}}{\text{m}^3}$$

$$c_{B8} := \sqrt{\frac{E_{B8}}{\rho_{B8}}} = 1.778 \times 10^3 \frac{\text{m}}{\text{s}}$$

$$E_{B9} := 5.19145 \cdot 10^9 \cdot \text{Pa}$$

$$\rho_{B9} := 1317.78 \cdot \frac{\text{kg}}{\text{m}^3}$$

$$c_{B9} := \sqrt{\frac{E_{B9}}{\rho_{B9}}} = 1.985 \times 10^3 \frac{\text{m}}{\text{s}}$$

$$E_{B10} := 3.2688 \cdot 10^9 \cdot \text{Pa}$$

$$\rho_{B10} := 593.479 \cdot \frac{\text{kg}}{\text{m}^3}$$

$$c_{B10} := \sqrt{\frac{E_{B10}}{\rho_{B10}}} = 2.347 \times 10^3 \frac{\text{m}}{\text{s}}$$

Stresses Rod B

Layer 1:

$$\sigma_{B1.I} := \frac{F}{A} = 0.775 \cdot \text{MPa}$$

Initial stress wave of Rod A and B

$$\sigma_{B1.R} := \frac{\rho_{B2} \cdot c_{B2} - \rho_{B1} \cdot c_{B1}}{\rho_{B2} \cdot c_{B2} + \rho_{B1} \cdot c_{B1}} \cdot \sigma_{I1} = -0.129 \cdot \text{MPa}$$

Reflected stress wave, first layer in Rod B

$$\sigma_{B1.T} := \frac{2 \cdot \rho_{B2} \cdot c_{B2}}{\rho_{B1} \cdot c_{B1} + \rho_{B2} \cdot c_{B2}} \cdot \sigma_{I1} = 0.646 \cdot \text{MPa}$$

Transmitted stress wave, first layer in Rod B

$$\sigma_{B1.T} - \sigma_{A1.R} = 0.775 \cdot \text{MPa}$$

Transmitted stress wave minus reflected stress wave equals to the initial stress wave, meaning that the first layer is in balance

$$U_{PI.B1} := \frac{\sigma_{B1.I}}{\rho_{B1} \cdot c_{B1}} = 0.019 \frac{\text{m}}{\text{s}}$$

Initial particle velocity, first layer of Rod B

$$U_{PR.B1} := \frac{-\sigma_{B1.R}}{\rho_{B1} \cdot c_{B1}} = 3.196 \times 10^{-3} \frac{\text{m}}{\text{s}}$$

Reflected particle velocity, first layer of Rod B

$$U_{PT.B1} := \frac{\sigma_{B1.T}}{\rho_{B2} \cdot c_{B2}} = 0.022 \frac{\text{m}}{\text{s}}$$

Transmitted particle velocity, first layer of Rod B

$$U_{PT.B1} - U_{PR.B1} = 0.019 \frac{\text{m}}{\text{s}}$$

Transmitted particle velocity minus reflected particle velocity equals to the initial particle velocity, meaning that the first layer is in balance

Layer 2:

$$\sigma_{B2.I} := \sigma_{B1.T} = 0.646 \cdot \text{MPa} \quad \text{Incident stress wave}$$

$$\sigma_{B2.R} := \frac{\rho_{B3} \cdot c_{B3} - \rho_{B2} \cdot c_{B2}}{\rho_{B3} \cdot c_{B3} + \rho_{B2} \cdot c_{B2}} \cdot \sigma_{B2.I} = -0.115 \cdot \text{MPa} \quad \text{Reflected stress wave, second layer in Rod B}$$

$$\sigma_{B2.T} := \frac{2 \cdot \rho_{B3} \cdot c_{B3}}{\rho_{B2} \cdot c_{B2} + \rho_{B3} \cdot c_{B3}} \cdot \sigma_{B2.I} = 0.532 \cdot \text{MPa} \quad \text{Transmitted stress wave, second layer in Rod B}$$

$$\sigma_{B2.T} - \sigma_{B2.R} = 0.646 \cdot \text{MPa} \quad \text{Transmitted stress wave minus reflected stress wave equals to the initial stress wave, meaning that the second layer is in balance}$$

$$U_{PI.B2} := \frac{\sigma_{B2.I}}{\rho_{B2} \cdot c_{B2}} = 0.022 \frac{\text{m}}{\text{s}} \quad \text{Incident particle velocity, second layer of Rod B}$$

$$U_{PR.B2} := \frac{-\sigma_{B2.R}}{\rho_{B2} \cdot c_{B2}} = 3.976 \times 10^{-3} \frac{\text{m}}{\text{s}} \quad \text{Reflected particle velocity, second layer of Rod B}$$

$$U_{PT.B2} := \frac{\sigma_{B2.T}}{\rho_{B3} \cdot c_{B3}} = 0.026 \frac{\text{m}}{\text{s}} \quad \text{Transmitted particle velocity, second layer of Rod B}$$

$$U_{PT.B2} - U_{PR.B2} = 0.022 \frac{\text{m}}{\text{s}} \quad \text{Transmitted particle velocity minus reflected particle velocity equals to the incident particle velocity, meaning that the second layer is in balance}$$

Layer 3:

$$\sigma_{B3.I} := \sigma_{B2.T} = 0.532 \cdot \text{MPa} \quad \text{Incident stress wave}$$

$$\sigma_{B3.R} := \frac{\rho_{B4} \cdot c_{B4} - \rho_{B3} \cdot c_{B3}}{\rho_{B4} \cdot c_{B4} + \rho_{B3} \cdot c_{B3}} \cdot \sigma_{B3.I} = -0.099 \cdot \text{MPa} \quad \text{Reflected stress wave, third layer in Rod B}$$

$$\sigma_{B3.T} := \frac{2 \cdot \rho_{B4} \cdot c_{B4}}{\rho_{B3} \cdot c_{B3} + \rho_{B4} \cdot c_{B4}} \cdot \sigma_{B3.I} = 0.433 \cdot \text{MPa} \quad \text{Transmitted stress wave, third layer in Rod B}$$

$$\sigma_{B3.T} - \sigma_{B3.R} = 0.532 \cdot \text{MPa} \quad \text{Transmitted stress wave minus reflected stress wave equals to the initial stress wave, meaning that the third layer is in balance}$$

$$U_{PI.B3} := \frac{\sigma_{B3.I}}{\rho_{B3} \cdot c_{B3}} = 0.026 \frac{\text{m}}{\text{s}} \quad \text{Incident particle velocity, third layer of Rod B}$$

$$U_{PR.B3} := \frac{-\sigma_{B3.R}}{\rho_{B3} \cdot c_{B3}} = 4.904 \times 10^{-3} \frac{\text{m}}{\text{s}} \quad \text{Reflected particle velocity, third layer of Rod B}$$

$$U_{PT.B3} := \frac{\sigma_{B3.T}}{\rho_{B4} \cdot c_{B4}} = 0.031 \frac{\text{m}}{\text{s}} \quad \text{Transmitted particle velocity, third layer of Rod B}$$

$$U_{PT.B3} - U_{PR.B3} = 0.026 \frac{\text{m}}{\text{s}} \quad \text{Transmitted particle velocity minus reflected particle velocity equals to the incident particle velocity, meaning that the third layer is in balance}$$

Layer 4:

$$\sigma_{B4.I} := \sigma_{B3.T} = 0.433 \cdot \text{MPa} \quad \text{Incident stress wave}$$

$$\sigma_{B4.R} := \frac{\rho_{B5} \cdot c_{B5} - \rho_{B4} \cdot c_{B4}}{\rho_{B5} \cdot c_{B5} + \rho_{B4} \cdot c_{B4}} \cdot \sigma_{B4.I} = -0.081 \cdot \text{MPa} \quad \text{Reflected stress wave, fourth layer in Rod B}$$

$$\sigma_{B4.T} := \frac{2 \cdot \rho_{B5} \cdot c_{B5}}{\rho_{B4} \cdot c_{B4} + \rho_{B5} \cdot c_{B5}} \cdot \sigma_{B4.I} = 0.352 \cdot \text{MPa} \quad \text{Transmitted stress wave, fourth layer in Rod B}$$

$$\sigma_{B4.T} - \sigma_{B4.R} = 0.433 \cdot \text{MPa} \quad \text{Transmitted stress wave minus reflected stress wave equals to the initial stress wave, meaning that the fourth layer is in balance}$$

$$U_{PI.B4} := \frac{\sigma_{B4.I}}{\rho_{B4} \cdot c_{B4}} = 0.031 \frac{\text{m}}{\text{s}} \quad \text{Incident particle velocity, fourth layer of Rod B}$$

$$U_{PR.B4} := \frac{-\sigma_{B4.R}}{\rho_{B4} \cdot c_{B4}} = 5.88 \times 10^{-3} \frac{m}{s}$$

Reflected particle velocity, fourth layer of Rod B

$$U_{PT.B4} := \frac{\sigma_{B4.T}}{\rho_{B5} \cdot c_{B5}} = 0.037 \frac{m}{s}$$

Transmitted particle velocity, fourth layer of Rod B

$$U_{PT.B4} - U_{PR.B4} = 0.031 \frac{m}{s}$$

Transmitted particle velocity minus reflected particle velocity equals to the incident particle velocity, meaning that the fourth layer is in balance

Layer 5:

$$\sigma_{B5.I} := \sigma_{B4.T} = 0.352 \cdot \text{MPa}$$

Incident stress wave

$$\sigma_{B5.R} := \frac{\rho_{B6} \cdot c_{B6} - \rho_{B5} \cdot c_{B5}}{\rho_{B6} \cdot c_{B6} + \rho_{B5} \cdot c_{B5}} \cdot \sigma_{B5.I} = -0.063 \cdot \text{MPa}$$

Reflected stress wave, fifth layer in Rod B

$$\sigma_{B5.T} := \frac{2 \cdot \rho_{B6} \cdot c_{B6}}{\rho_{B5} \cdot c_{B5} + \rho_{B6} \cdot c_{B6}} \cdot \sigma_{B5.I} = 0.289 \cdot \text{MPa}$$

Transmitted stress wave, fifth layer in Rod B

$$\sigma_{B5.T} - \sigma_{B5.R} = 0.352 \cdot \text{MPa}$$

Transmitted stress wave minus reflected stress wave equals to the initial stress wave, meaning that the fifth layer is in balance

$$U_{PI.B5} := \frac{\sigma_{B5.I}}{\rho_{B5} \cdot c_{B5}} = 0.037 \frac{m}{s}$$

Incident particle velocity, fifth layer of Rod B

$$U_{PR.B5} := \frac{-\sigma_{B5.R}}{\rho_{B5} \cdot c_{B5}} = 6.661 \times 10^{-3} \frac{m}{s}$$

Reflected particle velocity, fifth layer of Rod B

$$U_{PT.B5} := \frac{\sigma_{B5.T}}{\rho_{B6} \cdot c_{B6}} = 0.044 \frac{m}{s}$$

Transmitted particle velocity, fifth layer of Rod B

$$U_{PT.B5} - U_{PR.B5} = 0.037 \frac{m}{s}$$

Transmitted particle velocity minus reflected particle velocity equals to the incident particle velocity, meaning that the fifth layer is in balance

Layer 6:

$$\sigma_{B6.I} := \sigma_{B5.T} = 0.289 \cdot \text{MPa} \quad \text{Incident stress wave}$$

$$\sigma_{B6.R} := \frac{\rho_{B7} \cdot c_{B7} - \rho_{B6} \cdot c_{B6}}{\rho_{B7} \cdot c_{B7} + \rho_{B6} \cdot c_{B6}} \cdot \sigma_{B6.I} = -0.046 \cdot \text{MPa} \quad \text{Reflected stress wave, sixth layer in Rod B}$$

$$\sigma_{B6.T} := \frac{2 \cdot \rho_{B7} \cdot c_{B7}}{\rho_{B6} \cdot c_{B6} + \rho_{B7} \cdot c_{B7}} \cdot \sigma_{B6.I} = 0.243 \cdot \text{MPa} \quad \text{Transmitted stress wave, sixth layer in Rod B}$$

$$\sigma_{B6.T} - \sigma_{B6.R} = 0.289 \cdot \text{MPa} \quad \text{Transmitted stress wave minus reflected stress wave equals to the initial stress wave, meaning that the sixth layer is in balance}$$

$$U_{PI.B6} := \frac{\sigma_{B6.I}}{\rho_{B6} \cdot c_{B6}} = 0.044 \frac{\text{m}}{\text{s}} \quad \text{Incident particle velocity, sixth layer of Rod B}$$

$$U_{PR.B6} := \frac{-\sigma_{B6.R}}{\rho_{B6} \cdot c_{B6}} = 6.979 \times 10^{-3} \frac{\text{m}}{\text{s}} \quad \text{Reflected particle velocity, sixth layer of Rod B}$$

$$U_{PT.B6} := \frac{\sigma_{B6.T}}{\rho_{B7} \cdot c_{B7}} = 0.051 \frac{\text{m}}{\text{s}} \quad \text{Transmitted particle velocity, sixth layer of Rod B}$$

$$U_{PT.B6} - U_{PR.B6} = 0.044 \frac{\text{m}}{\text{s}} \quad \text{Transmitted particle velocity minus reflected particle velocity equals to the incident particle velocity, meaning that the sixth layer is in balance}$$

Layer 7:

$$\sigma_{B7.I} := \sigma_{B6.T} = 0.243 \cdot \text{MPa} \quad \text{Incident stress wave}$$

$$\sigma_{B7.R} := \frac{\rho_{B8} \cdot c_{B8} - \rho_{B7} \cdot c_{B7}}{\rho_{B8} \cdot c_{B8} + \rho_{B7} \cdot c_{B7}} \cdot \sigma_{B7.I} = -0.034 \cdot \text{MPa} \quad \text{Reflected stress wave, seventh layer in Rod B}$$

$$\sigma_{B7.T} := \frac{2 \cdot \rho_{B8} \cdot c_{B8}}{\rho_{B7} \cdot c_{B7} + \rho_{B8} \cdot c_{B8}} \cdot \sigma_{B7.I} = 0.209 \cdot \text{MPa}$$

Transmitted stress wave, seventh layer in Rod B

$$\sigma_{B7.T} - \sigma_{B7.R} = 0.243 \cdot \text{MPa}$$

Transmitted stress wave minus reflected stress wave equals to the initial stress wave, meaning that the seventh layer is in balance

$$U_{PI.B7} := \frac{\sigma_{B7.I}}{\rho_{B7} \cdot c_{B7}} = 0.051 \frac{\text{m}}{\text{s}}$$

Incident particle velocity, seventh layer of Rod B

$$U_{PR.B7} := \frac{-\sigma_{B7.R}}{\rho_{B7} \cdot c_{B7}} = 7.149 \times 10^{-3} \frac{\text{m}}{\text{s}}$$

Reflected particle velocity, seventh layer of Rod B

$$U_{PT.B7} := \frac{\sigma_{B7.T}}{\rho_{B8} \cdot c_{B8}} = 0.058 \frac{\text{m}}{\text{s}}$$

Transmitted particle velocity, seventh layer of Rod B

$$U_{PT.B7} - U_{PR.B7} = 0.051 \frac{\text{m}}{\text{s}}$$

Transmitted particle velocity minus reflected particle velocity equals to the incident particle velocity, meaning that the seventh layer is in balance

Layer 8:

$$\sigma_{B8.I} := \sigma_{B7.T} = 0.209 \cdot \text{MPa}$$

Incident stress wave

$$\sigma_{B8.R} := \frac{\rho_{B9} \cdot c_{B9} - \rho_{B8} \cdot c_{B8}}{\rho_{B9} \cdot c_{B9} + \rho_{B8} \cdot c_{B8}} \cdot \sigma_{B8.I} = -0.033 \cdot \text{MPa}$$

Reflected stress wave, eighth layer in Rod B

$$\sigma_{B8.T} := \frac{2 \cdot \rho_{B9} \cdot c_{B9}}{\rho_{B8} \cdot c_{B8} + \rho_{B9} \cdot c_{B9}} \cdot \sigma_{B8.I} = 0.176 \cdot \text{MPa}$$

Transmitted stress wave, eighth layer in Rod B

$$\sigma_{B8.T} - \sigma_{B8.R} = 0.209 \cdot \text{MPa}$$

Transmitted stress wave minus reflected stress wave equals to the initial stress wave, meaning that the eighth layer is in balance

$$U_{PI.B8} := \frac{\sigma_{B8.I}}{\rho_{B8} \cdot c_{B8}} = 0.058 \frac{m}{s}$$

Incident particle velocity, eighth layer of Rod B

$$U_{PR.B8} := \frac{-\sigma_{B8.R}}{\rho_{B8} \cdot c_{B8}} = 9.169 \times 10^{-3} \frac{m}{s}$$

Reflected particle velocity, eighth layer of Rod B

$$U_{PT.B8} := \frac{\sigma_{B8.T}}{\rho_{B9} \cdot c_{B9}} = 0.067 \frac{m}{s}$$

Transmitted particle velocity, eighth layer of Rod B

$$U_{PT.B8} - U_{PR.B8} = 0.058 \frac{m}{s}$$

Transmitted particle velocity minus reflected particle velocity equals to the incident particle velocity, meaning that the eighth layer is in balance

Layer 9:

$$\sigma_{B9.I} := \sigma_{B8.T} = 0.176 \cdot \text{MPa}$$

Incident stress wave

$$\sigma_{B9.R} := \frac{\rho_{B10} \cdot c_{B10} - \rho_{B9} \cdot c_{B9}}{\rho_{B10} \cdot c_{B10} + \rho_{B9} \cdot c_{B9}} \cdot \sigma_{B9.I} = -0.054 \cdot \text{MPa}$$

Reflected stress wave, ninth layer in Rod B

$$\sigma_{B9.T} := \frac{2 \cdot \rho_{B10} \cdot c_{B10}}{\rho_{B9} \cdot c_{B9} + \rho_{B10} \cdot c_{B10}} \cdot \sigma_{B9.I} = 0.122 \cdot \text{MPa}$$

Transmitted stress wave, ninth layer in Rod B

$$\sigma_{B9.T} - \sigma_{B9.R} = 0.176 \cdot \text{MPa}$$

Transmitted stress wave minus reflected stress wave equals to the initial stress wave, meaning that the ninth layer is in balance

$$U_{PI.B9} := \frac{\sigma_{B9.I}}{\rho_{B9} \cdot c_{B9}} = 0.067 \frac{m}{s}$$

Incident particle velocity, ninth layer of Rod B

$$U_{PR.B9} := \frac{-\sigma_{B9.R}}{\rho_{B9} \cdot c_{B9}} = 0.02 \frac{m}{s}$$

Reflected particle velocity, ninth layer of Rod B

$$U_{PT.B9} := \frac{\sigma_{B9.T}}{\rho_{B10} \cdot c_{B10}} = 0.088 \frac{m}{s}$$

Transmitted particle velocity, ninth layer of Rod B

$$U_{PT.B9} - U_{PR.B9} = 0.067 \frac{m}{s}$$

Transmitted particle velocity minus reflected particle velocity equals to the incident particle velocity, meaning that the ninth layer is in balance

Layer 10:

$$\sigma_{B10.I} := \sigma_{B9.T} = 0.122 \cdot \text{MPa}$$

Incident stress wave

$$\sigma_{B10.R} := \sigma_{B9.T} = 0.122 \cdot \text{MPa}$$

Reflected stress wave, tenth layer in Rod B

No transmitted stress wave in tenth layer

$$\sigma_{B10.I} + \sigma_{B10.R} = 0.244 \cdot \text{MPa}$$

Balance in the layer

$$U_{PI.B10} := \frac{\sigma_{B10.I}}{\rho_{B10} \cdot c_{B10}} = 0.088 \frac{m}{s}$$

Incident particle velocity, tenth layer of Rod B

$$U_{PR.B10} := U_{PI.B10} = 0.088 \frac{m}{s}$$

Reflected particle velocity, tenth layer of Rod B

No transmitted stress wave in tenth layer

$$U_{PR.B10} - U_{PI.B10} = 0 \frac{m}{s}$$

Balance in the layer

F MATLAB code, Case study 5

```
close all
clear all
clc
%-----
% Program to calculate the needed number of layers in a rod and the
% transmitted and reflected stress. Materials are approximated from a list
% of materials which are used in further calculations
%
% Written by:
% Tim Svensson
% Filip Tell
%-----

%% ----- Input data -----
mat=1;           % Defines the material in the first layer
b=0.7;          % [-] Lower E and rho by a factor b
sigma_I=100e6;  % [Pa] Initial stress in the first layer

% Loading the material data (E and rho) from an external document
[Material, rho, E,] = textread('material.txt', '%s %f %f');

%%
% Transform youngs modulus from MPa to Pa
for i=1:length(E)
    E(i)=E(i)*1e9;      % [Pa]
end

% Define the product between rho and E for all the materials from the input
% file
for p=1:length(E)
    Z(p)=E(p)*rho(p);
end

% Transpose of Z
Z=Z';

% Pre-define n and i
n=0;
i=1;

%-----
% Material in the first layer
% ( Want to have the material with the largest product of E and rho)
if mat == 2
    % Cermets
    rho_1=11500;        % [kg/m^3]
    E_1=470e9;         % [Pa]
    Z_1=rho_1*E_1;
else
    % Steel
    rho_1=7850;        % [kg/m^3]
    E_1=210e9;        % [Pa]
    Z_1=rho_1*E_1;
end

%% ----- Calculations -----

% Define the material properties for the second layer
E_2=b*E_1;
rho_2=b*rho_1;

% Initial transmitted wave, just an arbitrary start value
sigma_T=10000000;
```

```

%-----
% Iterate the transmitted wave until the threshold is reached. The loop
% breaks if the number of layers is greater than 50, or if the product of
% rho and E is lower than 10e12.

while sigma_T > 1000

sigma_T(i,1)=((2*sqrt(rho_2*E_2))/(sqrt(rho_2*E_2)+...
            sqrt(rho_1(i,1)*E_1(i,1))))*sigma_I;

sigma_I=sigma_T(i,1);
i=1+i;

% Defines new properties for the current layer
E_1(i,1)=E_2;
rho_1(i,1)=rho_2;

% Defines new properties for the next layer
E_2=b*E_1(i,1);
rho_2=b*rho_1(i,1);

n(i)=n(i-1)+1;

% Break if the number of layers exceed 10
    if i>9
        break
    end

end

%% -----

k=3;          % Polynomial grade for Youngs modulus
u=3;          % Polynomial grade for the Density

x=linspace(0.05,0.95,10)'; % Defines the thickness of each layer

p=polyfit(x,E_1,k);          % Find a polynomial which fit
                             % the calculated curve

r=polyfit(x,rho_1,u);        % Find a polynomial which fit
                             % the calculated curve

% Define the equation for Youngs modulus and the density
if k==2
    Emod_app=((p(1,1)*x.^2)+(p(1,2).*x)+p(1,3));
    rho_app=((r(1,1)*x.^2)+(r(1,2).*x)+r(1,3));
end

if k==3
    Emod_app=((p(1,1)*x.^3)+(p(1,2)*x.^2)+(p(1,3).*x)+p(1,4));
    rho_app=((r(1,1)*x.^3)+(r(1,2)*x.^2)+(r(1,3).*x)+r(1,4));
end

%% Calculating the transmitted stress for the approximated curve

% Initial value for the transmitted stress
stress1_I=100e6;

% Calculate the product between E and rho for each layer in the

```

```

% approximated curve

for i=1:10
    Z_app(i,1)=Emod_app(i,1)*rho_app(i,1);
end

for i=1:9
    % Calculate the transmitted stress for the new curve
    stress_T2(i,1)=((2*sqrt(Z_app(i+1,1)))/(sqrt(Z_app(i+1,1))+...
    sqrt(Z_app(i,1))))*stress1_I(i,1);

    % Defining the new incoming stress for the next layer
    stress1_I(i+1,1)=stress_T2(i,1);
end

%% Indata from Mathematica to calculate the new behaviour

% Cermets as first material in the rod, transformed values
if mat==2
    Emod_m=[4.21645*10^11, 2.44781*10^11, 1.38421*10^11, 7.74485*10^10,...
            4.42*10^10, 2.69609*10^10, 1.84519*10^10, 1.43182*10^10,...
            1.1619*10^10, 7.31589*10^9]';

    rho_m=[12631.4, 11124.5, 9607.18, 8097.87, 6634.33, 5271.59, 4053.21,...
           2964.86, 1930.5, 869.428]';

% Steel as first material in the rod, transformed values
else
    Emod_m=[1.88395*10^11, 1.0937*10^11, 6.18479*10^10, 3.46046*10^10,...
            1.97489*10^10, 1.20464*10^10, 8.24447*10^9, 6.39751*10^9,...
            5.19145*10^9, 3.2688*10^9]';

    rho_m=[8622.28, 7593.68, 6557.95, 5527.68, 4528.65, 3598.43, 2766.75,...
           2023.84, 1317.78, 593.479]';

% Linear psi(x)
%Emod_m=[1.04229*10^11, 7.45281*10^10, 5.20824*10^10, 3.57671*10^10,...
%         2.44569*10^10, 1.70267*10^10, 1.23513*10^10, 9.30547*10^9,...
%         6.76411*10^9, 3.60198*10^9]';

%rho_m=[15584.8, 11143.7, 7787.56, 5348.03, 3656.88, 2545.89, 1846.81,...
%        1391.39, 1011.4, 538.582]';

end

%% ----- Find real material properties for each layer -----
% Finding material properties for each layer from the indata file. The loop
% goes through all the layers and find the most suitable properties

% Calculate the product between E and rho which is the parameter used to
% find the materials for each layer
for i=1:10
    Z_m(i,1)=Emod_m(i,1)*rho_m(i,1);
end

for j=1:10
    val_Z=Z_m(j);

```



```

skill=abs(Z-val_Z);

[idx idx]=min(skill);

% Material name
Z_layerN(j,1)=Material(idx);

% Product between E and rho
Z_layer(j,1)=Z(idx);

% E for each material
E_layer(j,1)=E(idx);

% Rho for each material
rho_layer(j,1)=rho(idx);

end
%
% %-----
% Adding all the results from previuos calculation in to one matrix

for k=1:10
    used_mat(k,:)={Z_layerN(k,1), E_layer(k,1), rho_layer(k,1),...
                  Z_layer(k,1)};
end
% %-----

% Calculating the wave velocites
% For the chosed materials
for i=1:length(used_mat)
    c_cmat(i,1)=sqrt(E_layer(i,1)/rho_layer(i,1));
    c_cal1(i,1)=sqrt(Emod_app(i,1)/rho_app(i,1));
    c_cal2(i,1)=sqrt(Emod_m(i,1)/rho_m(i,1));
end

l_change1=1./(c_cal1./0.1);

% New lengths of the layers for the rod with real materials
new_length1=c_cmat.*l_change1;

% Total length of the rod with real materials
sum(new_length1)

%% --- Calculate the actual transmitted stress with the chosen layers -----

i=0;
% The initial stress in the first layer
stress_I=100e6;

for i=1:length(Z_layer)-1

    % Calculating the transmitted stress with real materials
    stress_T3(i,1)=((2*sqrt(Z_layer(i+1,1)))/(sqrt(Z_layer(i+1,1))+...
    sqrt(Z_layer(i,1))))*stress_I(i,1);

    % Calculating the reflected stress with real materials
    sigma_R(i,1)=(sqrt(Z_layer(i+1,1))-sqrt(Z_layer(i,1)))/...
    (sqrt(Z_layer(i,1))+sqrt(Z_layer(i+1,1)))*stress_I(i,1);

    % Defining the new incoming stress for the next layer
    stress_I(i+1,1)=stress_T3(i,1);

```

```
end

%
%% Plottar
figure(1)
hold on

subplot(2,1,1)
plot(x,E_1*10^-9,'black',x,Emod_app*10^-9,'-.')
grid
legend('Calculated behavoir', 'Approximated behavoir')
title('Variation of Youngs modulus')
xlabel('Number of layers')
ylabel('Youngs Modulus, [GPa]')

subplot(2,1,2)
plot(x,rho_1,'black',x,rho_app,'-.')
grid
legend('Calculated behavoir', 'Approximated behavoir')
title('Variation of the density')
xlabel('Number of layers')
ylabel('Density, [kg/m^3]')

hold off

% Plotting calculated transmitted stress
figure(2)
hold on
plot(2:10,sigma_T*10^-6,'black')
grid
title('Variation of the theoretically calculated transmitted stress')
xlabel('Number of layers')
ylabel('Transmitted stress [MPa]')
hold off

figure(3)
hold on
plot(x,E_1*10^-9,'black',x,Emod_app*10^-9,'-.',x,E_layer(:,1)*10^-9)
grid
legend('Calculated behavoir', 'Approximated behavoir',...
       'With real materials')
title('Youngs modulus in each layer with real materials')
ylabel('Youngs modulus')
xlabel('Number of layers')
hold off

figure(4)
hold on
plot(x,rho_layer(:,1),x,rho_app,x,rho_1)
grid
legend('Calculated behavoir', 'Approximated behavoir',...
       'With real materials')
ylabel('Density')
xlabel('Number of layers')
title('Density in each layer with real materials')
hold off

figure(5)
hold on
plot(2:10,stress_T2*10^-6,2:10,sigma_T*10^-6,'black',...
```

```
    2:10, stress_T3*10^-6, '-.')
grid
legend('From approximated curve', 'From theoretically calculated curve',...
       'With real materials')
title('Transmitted stress changes during calculation')
ylabel('Stress')
xlabel('Number of layers')
hold off
```

G List of materials

Material	Young's modulus [GPa]	Density [kg/m ³]
Alumina	390	3900
Alumina alloy	70	2700
Bamboo	17	700
Beryllium alloy	245	2900
Brass	130	8400
Cermets	470	11500
CFRP (graphite)	1,5	1500
Concrete	48	2500
Copper alloy	135	8300
Cork	0,32	180
Epoxy thermoset	3,5	1200
GRFP (glass)	26	1800
Glass (soda)	65	2500
Granite	66	2600
Lead alloys	16	11100
Magnesium alloy	44	1800
Nickel alloy	180	8500
Nylon	2,9	1130
Neopren	0,01	1240
Polycarbonate	2,7	1200
Polyurethan elastomer	0,25	1200
Polypropylen	0,9	890
Polyester thermoset	3,5	1300
PVC	1,5	1400
Polyehtylene	0,7	0,95
Silicon	110	2300
Steel	210	7800
Titanium alloy	100	4500
Tungsten carbide	550	15500
Zink alloy	75	5500

Data taken from:

<http://ocw.mit.edu/courses/materials-science-and-engineering/3-11-mechanics-of-materials-fall-1999/modules/props.pdf>